

ART BEARINGS

**ROLLING BEARINGS
GENERAL CATALOG**

www.anadolurulman.com.tr



ART
Rolling Bearings
General Catalogue

URB Group Companies

SC RULMENTI SA Barlad

320 Republicii street , zip code 731130, Barlad ROMANIA

Tel.: +40 235 411 120

Fax: +36 23 382 822

Anadolu Rulman Imalat Sanayi ve Ticaret A.Ş.

Yaka Mah. 401. Sok. No:17 CUMAYERI/DUZCE TURKEY

Tel.: +90 380 735 51 54

Fax: +90 380 735 51 77

New MGM Zrt.

Gyar u. 2, H 2049 Diosd HUNGARY

Tel: +36 23 546 300

Fax: +36 23 382 822

URB India Bearing Factory & Trade Pvt ltd

Unit No. 925-926, 9th floor, JMD Megapolis, Sector- 48

















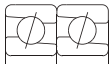







Sohna Road Gurgaon -122018 (Haryana)

This catalogue or parts there of may not be reproduced without URB GROUP permission.

Every care has been taken to ensure the correctness of this catalogue informational content, but no liability can be accepted for any errors or omissions.

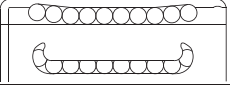
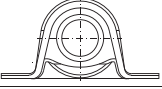

ART BEARINGS

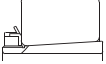
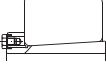
Selection of bearing type	page 8					
Selection of bearing size	page 12					
Bearing tolerances	page 25					
Bearing applications	page 43					
Bearing lubrication	page 62					
Bearing designation	page 70					
Mounting and dismounting	page 72					
Deep groove ball bearings	page 81	618 619 160 622 623 63 64	60 622 623 63 64			
					2ZR	2RSR
Self-aligning ball bearings	page 117	12 13	22 23			
					K	2RSR
Angular contact ball bearings	page 133	72B 73B 70C	72A 72C 72A			
				B	BDT	BDB
Cylindrical roller bearings	page 143	28 19 29 10 20	22 3 23 4			
				NU	NJ	NUP
Tapered roller bearings	page 215	329 320 302 322	303 313 323			
					R	
Spherical roller bearings	page 241	239 230 240 231 241	222 232 213 223			
				MB	C	
Thrust ball bearings	page 327	511 512 513 514			522 523 524	
Cylindrical roller thrust bearings	page 357	811 812 851 852	522 523 524			
Needle roller bearings	page 368	48 49 40				
					NA	
Spherical plain bearings	page 373	GE GA GX			SQ	
Rod ends						
Linear ball bushing	page 419					
Pillow blocks	page 435	SB UC SA	UE UK UC			
Accessories	page 579	H2 H22 H3 H23	H30 H31 H32			



2Z



2RS



K



N



NR

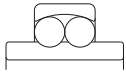

112;113

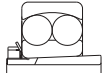

K + H

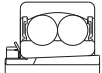

K2RSR + H

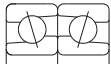

BDF



CTA
ATA



CTB
ATB

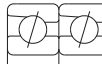

CTBDT
ATBDT

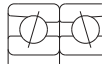

CTBDB
ATBDB

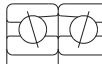

CTBDF
ATBDF



N



NJ+HJ



NU+HJ



NCF...V



NJ...VH

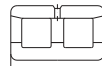

NN30

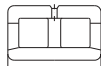

NNU49



MBK



CK



MBK+H



CK+H



MBK+AH



CK+AH

AH30 AH3
 AH31 AH23
 AH2 AH240
 AH22 AH241
 AH32



Measuring units of the international system SI

Lenght

1 mm = 0,039 in

1 in = 25,4 mm

Mass

1 kg = 2,205 lb

Force

1 kN = 1 000 N = 225 lbf

1 kgf = 9,81 N

1 lbf = 4,45 N

Moment

1 N mm = 0,102 kgf mm

1 kgf mm = 9,81 N mm

1 N m = 8,85 in lbf

1 in lbf = 0,113 N mm

Pressure per unit of area (surface)

1 N/mm² = 1 MPa = 145 psi

1 psi = 0,102 kgf/mm²

1 kgf/mm² = 9,81 N/mm²

Power

1 W = 1 J/s = 1 N m/s = 0,102 kgf m/s

1 kW = 1,36 CP = 102 kgf m/s

1 kgf m/s = 9,81 N m/s = 9,81 j/s

Mechanical work

1 kgf m = 9,81 W s = 9,81 N m

1 J (Joule) = 1 N m = 1 W s = 0,102 kgf m

Kinematic viscosity

1 mm²/s = 1 cSt (centiStokes)

URB GROUP

URB-ROMANIA ART-TURKEY MGM-HUNGARY URB-INDIA



Selection of bearing type

Each type of bearing displays characteristics features which make it suitable for a certain application. Therefore, many bearings types and constructive versions have been developed so that they can satisfy various demands for rolling bearings. No general rule can be given, taking into account the great number of factors to be considered when selecting a bearing type.

We give further the most important criteria to be considered when selecting the bearing type.

Selection of bearing type, considering the load magnitude and direction

Radial load

Deep groove ball bearings are the most suitable types of bearings for light and moderate pure radial loads. For heavy radial load and where large-diameter shafts are used, double row cylindrical roller bearings are the adequate choice.

Axial load

For pure axial loads, single direction thrust ball bearings are used in case of loads acting in one directions. For loads acting in both directions, double direction thrust ball bearings are used. Angular contact thrust ball bearing and single or double row angular contact ball bearings, are used in case of light or moderate pure axial loads at moderate speeds.

For light axial loads at high speeds, deep groove ball bearings are suitable. Under the axial load, a contact angle different from 0° is generated in these bearings and therefore they operate as angular contact ball bearings.

In order to increase axial load carrying capacity, a larger clearance should be selected (C3, C4). For moderate axial loads at high speed, angular contact

ball bearings in tandem arrangement are used so that they can take over loads acting in both directions.

Combined load

In order to carry combined radial and axial loads acting simultaneously, bearings with a contact angle different from 0° are used. The greater the contact angle, the greater the axial load carrying capacity.

Self-aligning ball bearings, spherical roller bearings or cylindrical roller bearings (NJ, NUP, NJ + HJ types), can also accommodate combined loads of certain values. But there are some limit values of the ratio F_a/F_r , which are shown in bearing tables and cannot be exceeded. Cylindrical roller bearings can carry axial loads by means of the sliding friction on ribs. For this reason, the load is limited according to the indications on pages 158, 159.

Bearings which accommodate only one direction axial loads should always be mounted in pairs so that they can carry axial loads in both directions.

Selection of bearing type considering the alignment between shaft and housing

Angular misalignments occur generally when the shaft bends under the operating load or when bearings joint parts have deviations of form or position.

In such cases, self-aligning ball bearings, spherical roller bearings or spherical roller thrust bearings should be used.

A certain bearing bending angle which can compensate for errors of alignment and maximum angle values are shown for each type in the introductory texts of the table sections.

When misalignments should be compensated, radial and axial clearance are important. The larger the clearance, the greater the possibility of self-aligning.

If the misalignment exceeds the permissible values shown in the introductory texts of the bearing tables, the bearing rating life decreases. The greater the ratio Fr/C_{or} , the shorter the rating life. If $0,1 < Fr/C_{or} < 3$, the rating life decreases with about 25%.

Selection of bearing type considering the operating temperature

Bearings are generally used up to a temperature of maximum +120°C. In case of higher temperatures, bearings with special heat treatments should be used, in accordance with specifications on page 23. Sealed bearings, 2RS type, should be used at operating temperatures up to 80°C. If this temperature is exceeded, the efficiency of lubricants is considerably reduced.

Selection of bearing internal clearance

In most cases, while operating, bearings should have a small radial clearance that can be defined as "the possible value of displacement in radial direction of one bearing ring in relation to the other without parts deformations".

While operating, bearing internal clearance is different from the one at delivery, since the latter is reduced when mounting bearings with a certain tight fit.

Under operating conditions, internal clearance change is also caused by different temperatures between the outer and inner ring. Bearings are generally delivered with a normal radial or axial clearance according to the values shown for each rolling bearing group.

The decrease in radial clearance due to the tight fit and operating temperature is considered to be between 60-80% of the tightening value, depending on bearing series and size.

After the clearance in bearings has been decreased, a large enough operational clearance should remain, so that the lubricant film shouldn't be destroyed.

Deep groove ball bearings should have an operational clearance close to zero. There may be often a light preload, due to the point-contact between the rolling elements and raceways.

Small-sized cylindrical roller bearings should have an operational clearance of 5-10 µm and larger-sized bearings a clearance of 10-30 µm.

Bearings can also be manufactured - at request - with radial and axial clearance smaller (C1 and C2) or larger (C3, C4 and C5) than normal, so that the most favorable operating conditions for bearings should be assured.

Cylindrical roller bearings can be manufactured with non-interchangeable rings (suffix NA).

Bearings with non-interchangeable parts have a different radial clearance than bearings with interchangeable parts. Changing rings from one bearing to another is not allowed.

In case of bearings with interchangeable parts, rings may be changed and the values of radial clearance will not be altered.

Bearing types and technical characteristics

ART bearings can be manufactured in various type and size, so that they can meet the customers' requirements assuring a proper reliability for various applications.

Table 1.1 shows suitability of each group of bearings, considering the main technical characteristics.

Bearing type is selected depending on the technical characteristics required by a certain application.

A suggestive graphic symbol has been determined for each main technical characteristic. Thus, a proper bearing for each purpose can be easily chosen. According to the specifications in this catalogue, the proper type and size of bearing can be selected, together with all manufacturing and operating technical conditions.

Bearing types and their characteristics



























































































































































































 - excellent  - poor		Purely radial load	Purely axial load	Combined load	Moment load
 - good  - unsuitable					
 - fair  - single direction  - double direction					
Deep groove ball bearings					
Self-aligning ball bearings					
Angular contact ball bearings - single row					
- high precision					
- double rows					
Cylindrical roller bearings - NU; N					
- NJ, NU+HJ, NUP, NJ+HJ					
- NCF, NJ23VH					
- NNU, NN					
Spherical roller bearings					
Tapered roller bearings - single row					
Thrust ball bearing - single direction - double direction		 a	 b		

Table 1.1

Tolerance class	Quiet running	High speed	High stiffness	Compensation of misalignment	Low friction	Shock resistance	Located bearing	Non-located bearing	Axial displacement possible in bearing
									
									
								 ^a	
								 ^a	
									
									
									
									
									
									
									
									

Selection of bearing size

The size of a bearing is selected considering as usually factor magnitude of the load, and also selection depends on the operational rating life and prescribed operating safety.

Basic load ratings

The basic dynamic load rating C_r is used to evaluate bearing dimensions while rotating under load. It expresses the bearing admissible load which will give a basic rating life up to 1000 000 revolutions.

The basic dynamic load ratings of ART bearings have been determined in accordance with international standard ISO 281. The values are given in bearing tables.

Considering the basic dynamic load rating, can be calculated the service time until the "metal fatigue" of rolling contact surfaces appears, determining this way the rating life.

The other characteristic, basic static load rating C_{or} , is considered in case of low speeds, low oscillating movements or in the stationary case.

The basic static load rating is defined in accordance with ISO 76, as the load acting upon the stationary bearing. It corresponds to a calculated contact stress in the center of the contact area between the most heavily loaded rolling element and the raceway, of:

- 4 600 MPa for self-aligning ball bearings,
- 4 200 MPa for all other ball bearings,
- 4 000 MPa for all roller bearings.

This stress produces a permanent deformations of the rolling element and raceway which is about 0,0001 of the rolling element diameter. The loads are pure radial for radial bearings and pure axial for thrust bearings.

Bearing life

The life of a rolling bearing is defined as the number of revolutions or the number of operating hours, which the bearing is capable to endure, before

the first sign of metal fatigue occurs on one of its rings, on the raceway or the rolling elements.

If we want to consider only the fatigue of the bearing operating surfaces the following conditions have to be observed:

1. The forces and speeds considered when calculating the bearing should correspond to the real operating conditions.
2. Proper lubrication should be assured during the entire operating period.
3. If the bearing carries a light load, its failure is generated by wear.
4. Experience showed that the failure of many bearings was caused by other reasons than fatigue, such as: selection of an inadequate bearing type in a bearing assembly, improper operating conditions, lubrication contamination, etc.

Basic rating life

The basic rating life of a single bearing or a group of apparently identical bearings operating under identical conditions, is the life corresponding to a reliability of 90%.

Basic rating life is marked with L_{10} (millions of revolutions) or L_{10h} (operating hours).

L_{10} can be calculated using the equation:

$$L_{10} = \left(\frac{C}{P} \right)^p, \text{ where:}$$

- L_{10} - basic rating life, millions of revolutions,
- C - basic dynamic load rating, kN,
- P - equivalent dynamic bearing load, kN,
- p - exponent of the life equation
- $p = 3$ - for ball bearings
- $p = 10/3$ - for roller bearings

The equivalent dynamic bearing load, respectively the radial and axial load, acting simultaneously can be calculated using the following equations (applicable to ball and roller radial bearings):

$$P_r = F_r, \text{ kN,} \quad \text{- for pure radial load}$$

$$P_r = XF_r + YF_a, \text{ kN,} \quad \text{- for combined load}$$

For thrust ball bearings, the following equations can be used:

$$P_a = F_a, \text{ kN,} \quad \text{- for pure axial load}$$

$$P_a = XF_r + YF_a, \text{ kN,} \quad \text{- for combined load}$$

where:

$$F_r = \text{the radial component of the load, kN}$$

$$F_a = \text{the axial component of the load, kN}$$

In the texts preceding the bearing tables, for some groups of bearings there are given details for determining the equivalent load. Values of the coefficients X and Y can be found in tables.

For bearings operating at constant speed, the basic rating life expressed in operating hours can be calculated using the equation:

$$L_{10h} = \frac{1000000}{60n} \left(\frac{C}{P}\right)^p \quad \text{or} \quad L_{10h} = \frac{16666}{n} \left(\frac{C}{P}\right)^p$$

Where:

n = rotational speed, r/min

Values of the basic rating life L_{10} (millions of revolutions) as a function of the ratio C/P can be found in the table 2.1.

Values of the basic rating life L_{10h} (operating hours) as a function of the ratio C/P and speed n can be found in table 2.2 for ball bearings and table 2.3 for roller bearings.

When determining the bearing size it is necessary to base the calculations on the rating life corresponding to the purpose of operation.

Usually it depends on the machine type, service life and the requirements regarding operational safety.

Approximate values of the service life for various classes of machines and equipments for general purposes are given in table 2.4.

The basic rating life L_{10h} of the bearings can be determined as a function of service life, using the life

calculation chart on page 17.

The basic rating life of road and rail vehicle bearings, for axlebox bearings, is expressed as a function of the wheel diameter and covered distance (km), using the equation:

$$L_{10s} = \frac{\pi D}{1000} L_{10}$$

where:

L_{10} - basic rating life, millions of revolutions

L_{10s} - service life distance, millions of kilometers

D - wheel diameter, metres

Approximate values for the service life distance (kilometers covered), in case of light loaded cars and rail vehicles are given in table 2.5.

Load ratio C/P for various life L10 (millions of revolutions)

Table 2.1

L ₁₀	C/P		L ₁₀	C/P		L ₁₀	C/P	
	Ball bearings	Roller bearings		Ball bearings	Roller bearings		Ball bearings	Roller bearings
0,5	0,793	0,812	240	6,21	5,18	2000	12,6	9,78
0,75	0,909	0,917	260	6,38	5,3	2200	13	10,1
1	1	1	280	6,54	5,42	2400	13,4	10,3
1,5	1,14	1,13	300	6,69	5,54	2600	13,8	10,6
2	1,26	1,24	320	6,84	5,64	2800	14,1	10,8
3	1,44	1,39	340	6,98	5,75	3000	14,4	11
4	1,59	1,52	360	7,11	5,85	3200	14,7	11,3
5	1,71	1,62	380	7,24	5,94	3400	15	11,5
6	1,82	1,71	400	7,37	6,03	3600	15,3	11,7
8	2	1,87	420	7,49	6,12	3800	15,6	11,9
10	2,15	2	440	7,61	6,21	4000	15,9	12
12	2,29	2,11	460	7,72	6,29	4500	16,5	12,5
14	2,41	2,21	480	7,83	6,37	5000	17,1	12,9
16	2,52	2,3	500	7,94	6,45	5500	17,7	13,2
18	2,62	2,38	550	8,19	6,64	6000	18,2	13,6
20	2,71	2,46	600	8,43	6,81	6500	18,7	13,9
25	2,92	2,63	650	8,66	6,98	7000	19,1	14,2
30	3,11	2,77	700	8,88	7,14	7500	19,6	14,5
35	3,27	2,91	750	9,09	7,29	8000	20	14,8
40	3,42	3,02	800	9,28	7,43	8500	20,4	15,1
45	3,56	3,13	850	9,47	7,56	9000	20,8	15,4
50	3,68	3,23	900	9,65	7,7	9500	21,2	15,6
60	3,91	3,42	950	9,83	7,82	10000	21,5	15,8
70	4,12	3,58	1000	10	7,94	12000	22,9	16,7
80	4,31	3,72	1100	10,3	8,17	14000	24,1	17,5
90	4,48	3,86	1200	10,6	8,39	16000	25,2	18,2
100	4,64	3,98	1300	10,9	8,59	18000	26,2	18,9
120	4,93	4,2	1400	11,2	8,79	20000	27,1	1,5
140	5,19	4,4	1500	11,4	8,97	25000	29,2	20,9
160	5,43	4,58	1600	11,7	9,15	30000	31,1	22
180	5,65	4,75	1700	11,9	9,31			
200	5,85	4,9	1800	12,2	9,48			
220	6,04	5,04	1900	12,4	9,63			

Ball bearings - load ratio C/P for various rating lives L_{10h} (operating hours) at different speed n (rpm)

Table 2.2

L_{10h}	C/P when n =										
	50	100	150	200	250	300	400	500	750	1000	1500
100	0,67	0,84	0,97	1,06	1,14	1,22	1,34	1,44	1,65	1,82	2,08
500	1,14	1,44	1,65	1,82	1,96	2,08	2,29	2,47	2,82	3,11	3,56
1000	1,44	1,82	2,08	2,29	2,47	2,62	2,88	3,11	3,56	3,91	4,48
1250	1,55	1,96	2,24	2,47	2,66	2,82	3,11	3,35	3,83	4,22	4,83
1600	1,69	2,13	2,43	2,68	2,88	3,07	3,37	3,63	4,16	4,58	5,24
2000	1,82	2,29	2,62	2,88	3,11	3,30	3,63	3,91	4,48	4,93	5,65
2500	1,96	2,47	2,82	3,11	3,35	3,56	3,91	4,22	4,83	5,31	6,08
3200	2,13	2,68	3,07	3,37	3,63	3,86	4,25	4,58	5,24	5,77	6,60
4000	2,29	2,88	3,30	3,63	3,91	4,16	4,58	4,93	5,65	6,21	7,11
5000	2,47	3,11	3,56	3,91	4,22	4,48	4,93	5,31	6,08	6,69	7,66
6300	2,66	3,36	3,84	4,23	4,55	4,84	5,33	5,74	6,57	7,23	8,28
8000	2,88	3,63	4,16	4,58	4,93	5,24	5,77	6,21	7,11	7,83	8,96
10000	3,11	3,91	4,48	4,93	5,31	5,65	6,21	6,69	7,66	8,43	9,65
12500	3,35	4,22	4,83	5,31	5,27	6,08	6,69	7,21	8,25	9,09	10,4
16000	3,63	4,58	5,24	5,77	6,21	6,60	7,27	7,83	8,96	9,86	11,3
20000	3,91	4,93	5,65	6,21	6,69	7,11	7,83	8,43	9,65	10,6	12,2
25000	4,22	5,31	6,08	6,69	7,21	7,66	8,43	9,09	10,4	11,4	13,1
32000	4,58	5,77	6,60	7,27	7,83	8,32	9,16	9,86	11,3	12,4	14,2
40000	4,93	6,21	7,11	7,83	8,43	8,96	9,86	10,6	12,2	13,4	15,3
50000	5,31	6,69	7,66	8,43	9,09	9,65	10,6	11,4	13,1	14,4	16,5
63000	5,74	7,23	8,28	9,11	9,81	10,4	11,5	12,4	14,2	15,6	17,8
80000	6,21	7,83	8,96	9,86	10,6	11,3	12,4	13,4	15,3	16,9	19,3
100000	6,69	8,43	9,65	10,6	11,4	12,2	13,4	14,4	16,5	18,2	20,8
200000	8,43	10,6	12,2	13,4	14,4	15,3	16,9	18,2	20,8	22,9	26,2

L_{10h}	C/P when n =										
	2000	2500	3000	4000	5000	6000	8000	10000	15000	20000	30000
100	2,29	2,47	2,62	2,88	3,11	3,30	3,63	3,91	4,48	4,93	5,65
500	3,91	4,22	4,48	4,93	5,31	5,65	6,21	6,69	7,66	8,43	9,65
1000	4,93	5,31	5,65	6,21	6,69	7,11	7,83	8,43	9,65	10,6	12,2
1250	5,31	5,72	6,08	6,69	7,21	7,66	8,43	9,09	10,4	11,4	13,1
1600	5,77	6,21	6,60	7,27	7,83	8,32	9,16	9,86	11,3	12,4	14,2
2000	6,21	6,69	7,11	7,83	8,43	8,96	9,86	10,6	12,2	13,4	15,3
2500	6,69	7,21	7,66	8,43	9,09	9,65	10,6	11,4	13,1	14,4	16,5
3200	7,27	7,83	8,32	9,16	9,86	10,5	11,5	12,4	14,2	15,7	17,9
4000	7,83	8,43	8,96	9,86	10,6	11,3	12,4	13,4	15,3	16,9	19,3
5000	8,43	9,09	9,65	10,6	11,4	12,2	13,4	14,4	16,5	18,2	20,8
6300	9,11	9,81	10,4	11,5	12,4	13,1	14,5	15,6	17,8	19,6	22,5
8000	9,86	10,6	11,3	12,4	13,4	14,2	15,7	16,9	19,3	21,3	24,3
10000	10,6	11,4	12,2	13,4	14,4	15,3	16,9	18,2	20,8	22,9	26,2
12500	11,4	12,3	13,1	14,4	15,5	16,5	18,2	19,6	22,4	24,7	28,2
16000	12,4	13,4	14,2	15,7	16,9	17,9	19,7	21,3	24,3	26,8	30,7
20000	13,4	14,4	15,3	16,9	18,2	19,3	21,3	22,9	26,2	28,8	33,0
25000	14,4	15,5	16,5	18,2	19,6	20,8	22,9	24,7	28,2	31,1	35,6
32000	15,7	16,9	17,9	19,7	21,3	22,6	24,9	26,8	30,7	33,7	38,6
40000	16,9	18,2	19,3	21,3	22,9	24,3	26,8	28,8	33,0	36,3	41,6
50000	18,2	19,6	20,8	22,9	24,7	26,1	28,8	31,1	35,6	39,1	44,8
63000	19,6	21,1	22,5	24,7	26,6	28,3	31,2	33,6	38,4	42,3	48,4
80000	21,3	22,9	24,3	26,8	28,8	30,7	33,7	36,3	41,6	45,8	52,4
100000	22,9	24,7	26,2	28,8	31,1	33,0	36,3	39,1	44,8	49,3	56,5
200000	28,8	31,1	33,0	36,3	39,1	41,6	45,8	49,3	56,5	62,1	71,1

Roller bearings - load ratio C/P for various basic rating lives L_{10h} (operating hours) at various speeds n (rpm)

Table 2.3

L_{10h}	C/P when n=										
	50	100	150	200	250	300	400	500	750	1000	1500
100	0,70	0,86	0,97	1,06	1,13	1,19	1,30	1,39	1,57	1,71	1,93
500	1,13	1,39	1,57	1,71	1,83	1,93	2,11	2,25	5,24	2,77	3,13
1000	1,39	1,71	1,93	2,11	2,25	2,38	2,59	2,77	3,13	3,42	3,86
1250	1,49	1,83	2,07	2,25	2,41	2,54	2,77	2,97	3,35	3,65	4,12
1600	1,60	1,97	2,23	2,43	2,59	2,74	2,99	3,19	3,61	3,93	4,44
2000	1,71	2,11	2,38	2,59	2,77	2,93	3,19	3,42	3,86	4,20	4,75
2500	1,83	2,25	2,54	2,77	2,97	3,13	3,42	3,65	4,12	4,50	5,08
3200	1,97	2,43	2,74	2,99	3,19	3,37	3,68	3,93	4,44	4,84	5,47
4000	2,11	2,59	2,93	3,19	3,42	3,61	3,93	4,20	4,75	5,18	5,85
5000	2,25	2,77	3,13	3,42	3,65	3,86	4,20	4,50	5,08	5,54	6,25
6300	2,42	2,97	3,36	3,66	3,91	4,13	4,51	4,82	5,44	5,93	6,70
8000	2,59	3,19	3,61	3,93	4,20	4,44	4,84	5,18	5,85	6,37	7,20
10000	2,77	3,42	3,86	4,20	4,50	4,75	5,18	5,54	6,25	6,81	7,70
12500	2,97	3,65	4,12	4,50	4,81	5,08	5,54	5,92	6,68	7,29	8,23
16000	3,19	3,93	4,44	4,84	5,18	5,47	5,96	6,37	7,20	7,85	8,86
20000	3,42	4,20	4,75	5,18	5,54	5,85	6,37	6,81	7,70	8,39	9,48
25000	3,65	4,50	5,08	5,54	5,92	6,25	6,81	7,29	8,23	8,97	10,1
32000	3,93	4,84	5,47	5,96	6,37	6,73	7,34	7,85	8,86	9,66	10,9
40000	4,20	5,18	5,85	6,37	6,81	7,20	7,85	8,39	9,48	10,3	11,7
50000	4,50	5,54	6,25	6,81	7,29	7,70	8,39	8,97	10,1	11,0	12,5
63000	4,82	5,93	6,70	7,30	7,81	8,25	8,99	9,61	10,9	11,8	13,4
80000	5,18	6,37	7,20	7,85	8,39	8,86	9,66	10,3	11,7	12,7	14,4
100000	5,54	6,81	7,70	8,39	8,97	9,48	10,3	11,0	12,5	13,6	15,4
200000	6,81	8,39	9,48	10,3	11,0	11,7	12,7	13,6	15,4	16,7	18,9

L_{10h}	C/P when n =										
	2000	2500	3000	4000	5000	6000	8000	10000	15000	20000	30000
100	2,11	2,25	2,38	2,59	2,77	2,93	3,19	3,42	3,86	4,20	4,75
500	3,42	3,65	3,86	4,20	4,50	4,75	5,18	5,54	6,25	6,81	7,70
1000	4,20	4,50	4,75	5,18	5,54	5,85	6,37	6,81	7,70	8,39	9,48
1250	4,50	4,81	5,08	5,54	5,92	6,25	6,81	7,29	8,23	8,97	10,1
1600	4,84	5,18	5,47	5,96	6,37	6,73	7,34	1,85	8,86	9,66	10,9
2000	5,18	5,54	5,85	6,37	6,81	7,20	7,85	8,39	9,48	10,3	11,7
2500	5,54	5,92	6,25	6,81	7,29	7,70	8,39	8,97	10,1	11,0	12,5
3200	5,96	6,37	6,73	7,34	7,85	8,29	9,03	9,66	10,9	11,9	13,4
4000	6,37	6,81	7,20	7,85	8,39	8,86	9,66	10,3	11,7	12,7	14,4
5000	6,81	7,29	7,70	8,39	8,97	9,48	10,3	11,0	12,5	13,6	15,4
6300	7,30	7,81	8,25	8,99	9,61	10,2	11,1	11,8	13,4	14,6	16,5
8000	7,85	8,39	8,86	9,66	10,3	10,9	11,9	12,7	14,4	15,7	17,7
10000	8,39	8,97	9,48	10,3	11,0	11,7	12,7	13,6	15,4	16,7	18,9
12500	8,97	9,59	10,1	11,0	11,8	12,5	13,6	14,5	16,4	17,9	20,2
16000	9,66	10,3	10,9	11,9	12,7	13,4	14,6	15,7	17,7	19,3	21,8
20000	10,3	11,0	11,7	12,7	13,6	14,4	15,7	16,7	18,9	20,6	23,3
25000	11,0	11,8	12,5	13,6	14,5	15,4	16,7	17,9	20,2	22,0	24,9
32000	11,9	12,7	13,4	14,6	15,7	16,5	18,0	19,3	21,8	23,7	26,8
40000	12,7	13,6	14,4	15,7	16,7	17,7	19,3	20,6	23,3	25,4	28,7
50000	13,6	14,5	15,4	16,7	17,9	18,9	20,6	22,0	24,9	27,1	30,6
63000	14,6	15,6	16,5	17,9	19,2	20,3	22,1	23,6	26,7	29,1	32,8
80000	15,7	16,7	17,7	19,3	20,6	21,8	23,7	25,4	28,7	31,2	35,3
100000	16,7	17,9	18,9	20,6	22,0	23,3	25,4	27,1	30,6	33,4	37,7
200000	20,6	22,0	23,3	25,4	27,1	28,7	31,2	33,4	37,7	41,1	46,4

Basic rating life calculation chart

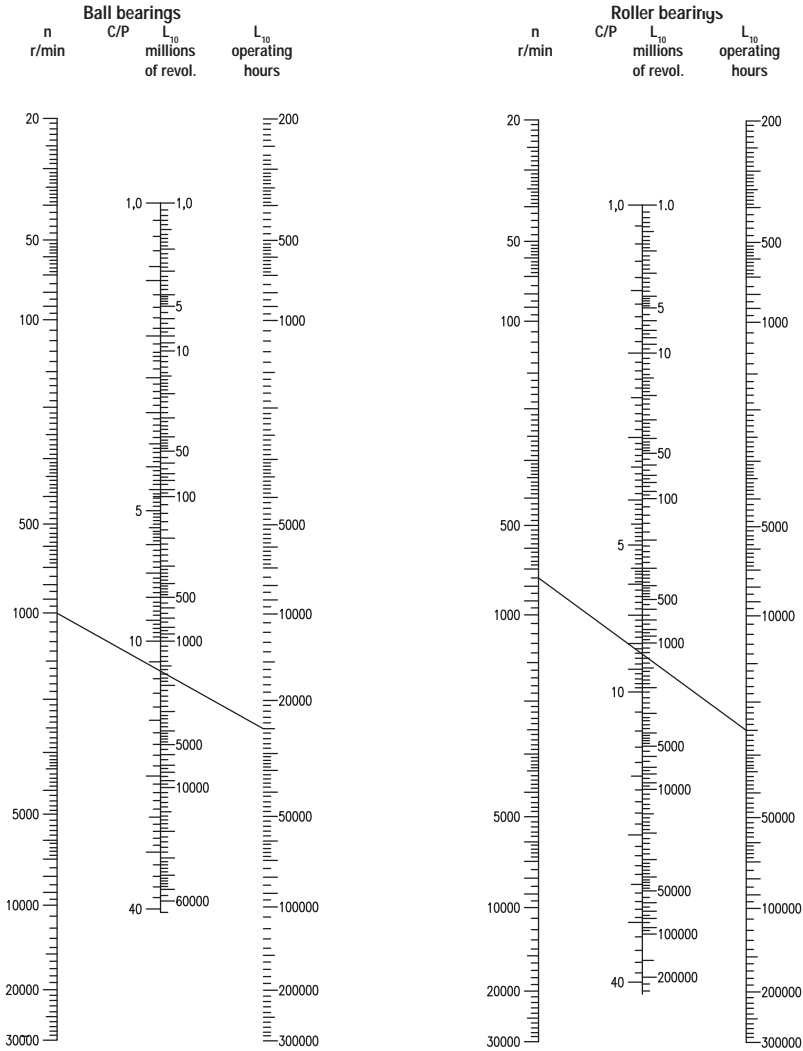

Example:

1. Determine the size of a deep groove ball bearing single row, considering the following conditions:

- Basic rating life $L_{10h} = 25000$ operating hours
- Rotational speed $n = 1000$ rpm
- Radial load $F_r = P = 5$ kN

In the chart we find report: $C/P = 11,6$; $C = 11,6 \times P = 11,6 \times 5 = 58$ kN. In the catalogue on page 100, you can select bearing 6310 type, with the following characteristics: $C_r = 61,8$ kN; $n_{lim} = 7000$ rpm.

2. What is the basic life of the bearing NU 210E, operating under radial load of 7,7 kN, at a rotational speed $n = 750$ rpm?

See page 172 in the catalogue and find for NU 210E type, the following values: $C_r = 64,4$ kN, $n_{lim} = 8000$ rpm. From the chart, for a roller bearing operated at 750 rpm, and $C_r/P = 64,4/7,7 = 8,36$ result is a rating life $L_{10h} = 25000$ hours.

Recommended basic rating lives for general purpose machines

Table 2.4

Application	Recommended basic rating life L_{10n} (operating hours)
Household machines, technical apparatus for medical use, instruments, agricultural machines:	300..3000
Machines used for short periods or intermittently: electric hand tools, cranes, lifting tackles in workshops, building machines:	3000..8000
Machines used intermittently or for short periods with high operational reliability: lifts, small cranes	8000..12000
Machines for use 8 hours/day but not always at full capacity: machines for general purposes, electric motors for industrial use, rotary crushers, gear drives for general purposes:	10000..25000
Machines operating 8 hours/day at full capacity: machine tools, woodworking machines, large cranes, printing equipment, ventilators, separators, centrifuges:	20000..30000
Machines for continuous use 24 hours/day: Rolling mill gear units, medium sized electrical machinery, compressors, pumps, textile machines, mine hoists:	40000..50000
Hydraulic machines, rotary furnaces, capstans, propulsion machinery for sea vessel (propellers for sea vessels):	50000..100000
Machines for continuous use 24 hour/day with high reliability: large electric machinery, mine pumps and mine ventilators, power station plants, machines for cellulose industry, pumping units:	100000..

Values for basic rating life L_{10s}

Table 2.5

Type of vehicle	$L_{10s}/10^6$ [km]
Wheel hub bearings automotive:	
- light loaded cars	0,3
- trucks, buses	0,6
Axlebox bearings rail vehicles:	
- freight wagons (according to UIC)	0,8
- suburban vehicles, trams	1,5
- long distance passenger carriages	3
- motorailers	3...4
- Diesel and electric locomotives	3...4

If oscillation of amplitude is very small, it can be ignored for basic dynamic rating life calculation. It will be only a static evaluation.

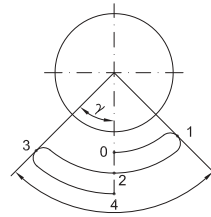

Fig. 1

Fluctuating dynamic load and speeds

In many cases, operation speed and magnitude of the load fluctuates. Therefore a mean dynamic load is to be calculated.

Complete oscillation = 4γ from point 0 to point 4. The load acting on the bearing can vary as shown in fig. 2-a and 2-b.

In this case, the mean load can be determined using the equation:

$$F_m = \sqrt{\frac{F_1^p n_1 + F_2^p n_2 + \dots + F_n^p n_n}{n}}$$

In case of bearings which do not rotate, but oscillates from a central position through an angle, as shown in fig. 1, basic rating life can be determined as follows:

$$L_{10osc} = \frac{180}{2\gamma} L_{10}$$

Where:

L_{10osc} = basic rating life, millions of cycles

γ = oscillation amplitude (angle of maximum deviation from centre position), degrees

Where:

F_m - constant mean load, kN

F_1, F_2, F_n - constant load during n_1, n_2, \dots, n_n revolutions, kN

n - total number of revolutions ($n=n_1+n_2+\dots+n_n$) during which loads F_1, F_2, \dots, F_n are acting

p - exponent,

$p = 3$ - for ball bearings

$p = 10/3$ - for roller bearings

If the bearing speed is constant and the magnitude of load is between the minimum value F_{min} and a maximum value F_{max} , as shown in fig. 3 a and b, the mean load can be obtained from:

$$F_m = \frac{F_{min} + 2F_{max}}{3}, \text{ kN}$$

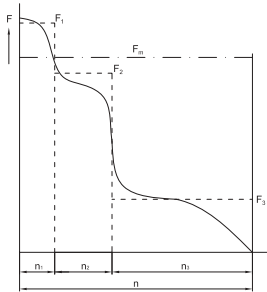

Fig. 2 a

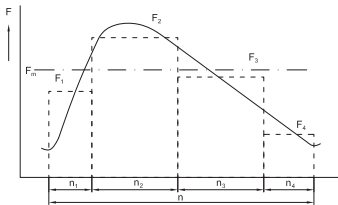

Fig. 2 b

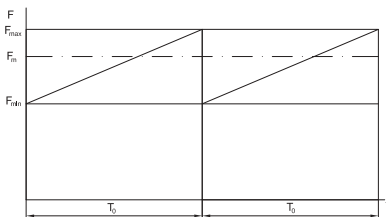

Fig. 3 a

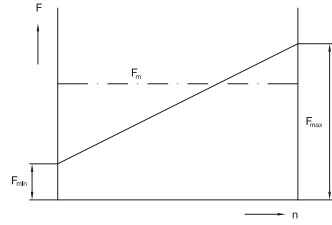

Fig. 3 b

If the external radial load consists in a load F_1 - constant as magnitude and direction) and a load F_2 - variable as direction and constant as magnitude (F_1, F_2 acting in the same plane) as shown in fig. 4, the mean load can be determined using the equation:

$$F_m = f_m(F_1 + F_2), \text{ kN}$$

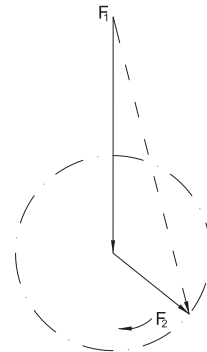

Fig. 4

Values for the factor f_m can be obtained from fig.5.

In case of sinusoidal movement as it shown in fig.6, the mean load can be obtained from equation:

$$F_m = \sqrt{\frac{p}{3\pi}} F_{max}, \text{ kN}$$

$$F_m \approx 0,75 F_{max}, \text{ kN, for ball bearings}$$

$$F_m \approx 0,77 F_{max}, \text{ kN, for roller bearings}$$

In case of oscillating movements with angle γ , as shown in fig. 7, equivalent mean load can be calculated with the equation:

$$F_m = \sqrt{\frac{\gamma}{90^\circ}} F_r, \text{ kN}$$

If the fluctuating load acts in a pure radial direction for radial bearings and in a pure axial direction for thrust bearings, the equivalent dynamic bearing load will be:

$$P_r = F_m$$

For combined loads, with radial load F_r and axial load F_a constant in direction and magnitude, the equivalent dynamic load can be calculated using the equation:

$$P_r = X F_r + Y F_a, \text{ kN}$$

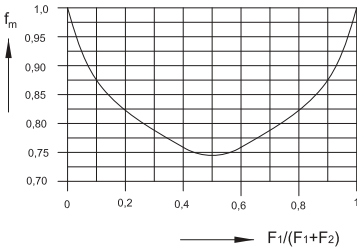

Fig. 5

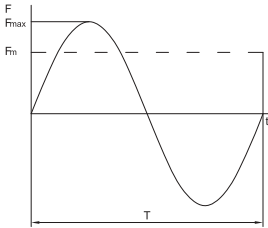

Fig. 6

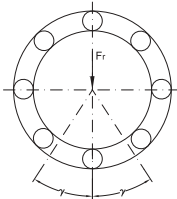

Fig. 7

In case of combined loads, with radial and axial loads changing in time, ratio F_r/F_a being constant, the equivalent dynamic load can be calculated by:

$$P_m = X F_{rm} + Y F_{am}, \text{ kN}$$

where:

P_m - equivalent mean dynamic load, kN

F_{rm} - radial mean load, kN

F_{am} - axial mean load, kN

X, Y - factors of radial and axial load.

If direction and magnitude of load changes in time and speeds fluctuates in time, the equivalent mean dynamic load will be calculated using the equation:

$$P_m = \sqrt[n]{\frac{P_1^p n_1 + P_2^p n_2 + \dots + P_n^p n_n}{n}}$$

where:

P_m - equivalent mean dynamic load, kN

P_1 - equivalent dynamic load for n_1 revolutions, kN

P_2 - equivalent dynamic load for n_2 revolutions, kN

P_n - equivalent dynamic load for n_n revolutions, kN

n_1 - number of revolutions for load P_1

n_2 - number of revolutions for load P_2

n_n - number of revolutions for load P_n

n - number of revolutions ($n = n_1 + n_2 + \dots + n_n$)

p - exponent: - 3 for ball bearings,

- 10/3 for roller bearings

Basic dynamic load of a bearing group

If heavy radial loads must be carried, it is required a bearing group of the same type, mounted close together, especially in case of ball and roller bearings. In order to take over the load uniformly, these bearings should be mounted with equal diameter deviations and also radial clearances. These deviations must be kept below half of the admitted tolerance class.

Basic dynamic load for a bearing group, as a function of the basic load of the single bearing, can be calculated using the equation:

$$C_{ri} = C_r^{j^n}$$

where:

C_{ri} - basic dynamic load of the bearing group, kN

C_r - basic dynamic load of the single bearing,

selected from the tables,

i - number of bearings of the same type, mounted close together,

n - exponent depending on the bearing type:

0,7 - for ball bearings

7/9 - for roller bearings

Values of i^n are given in table 2.6.

Values for i^n		
i	$i^{0,7}$	$i^{7/9}$
2	1,62	1,71
3	2,16	2,35
4	2,64	2,94

The equivalent basic dynamic load for each group of bearings is calculated considering specifications in the introductory text preceding the respective group.

Adjusted rating life

Basic rating life L10 is often satisfactory for bearing performances. This life means a reliability of 90% for standard material and modern and usual manufacturing technologies, as well as for conventional operating conditions.

For a reliability over 90%, international standards recommends steels elaborated in better conditions, high level manufacturing technologies and specific operating conditions. In this case adjusted rated life can be calculated as follows:

$$L_{na} = a_1 a_2 a_3 L_{10} \text{ or } L_{na} = a_1 a_2 a_3 \left(\frac{C}{P}\right)^p$$

where:

L_{na} – adjusted rating life, millions of revolutions

a_1 - life adjustment factor considering reliability

a_2 - life adjustment factor considering the material and manufacturing conditions

a_3 - life adjustment factor considering the operating conditions.

In case of life adjustment factors a_1, a_2, a_3

greater than 1, when calculating adjusted rating life, prudence is recommended, because knowledge about bearings manufacture and operating conditions (shaft bending, housing stiffness, lubrication, temperature influence, etc.).

Values of the life adjustment factor a_1 for reliabilities over 90% are given in table 2.7.

Values for factor a_1		
Reliability %	Lna	$a1$
90	L10a	1
95	L5a	0,62
96	L4a	0,53
97	L3a	0,44
98	L2a	0,33
99	L1a	0,21

Life adjustment factor a_2 for material

Life adjustment factor a_2 takes into account the material properties, heat treatment of the steel and manufacturing technologies. For ART bearings, $a_2=1$ is recommended.

Life adjustment factor a_{23} for operating conditions

The maximum life of a bearing can be reached in case of hydrodynamical lubrication, namely where is no direct contact between rolling elements and raceways due to the lubricant film. In this field, many studies have been done by world leading bearing manufacturers. These studies showed that there is a relationship between life adjustment factor a_2 for material and life adjustment factor a_3 for operating conditions. Preferably these factors should be unified, obtaining factor a_{23} . In this case, adjusted rating life would be:

$$L_n a = a_1 a_{23} L_{10}$$

These values of a_{23} factor depends on the lubricant used, namely on the ratio between the oil viscosity

required at $+40^{\circ}\text{C}$, ν (initial value) to the viscosity required for adequate lubrication at the operating temperature ν_1 . The values are given in table 2.8.

Values for factor a_{23}						Table 2.8			
$\frac{\nu}{\nu_1}$	0,1	0,2	0,5	1	1,5	2	3	4	5
a_{23}	0,45	0,55	0,75	1	1,3	1,6	2	2,5	2,5

The value of viscosity ν_1 , as a function of the mean bearing diameter and operating speed, are given in diagram fig. 8.

Kinematic viscosity ν at the temperature of $+40^{\circ}\text{C}$ can be determined from diagram fig. 9, in accordance with ISO, if the bearing operating temperature is known.

In case of grease lubrication, calculation should be done considering the basic oil viscosity and the value of the life adjustment factor a_{23} will be smaller than 1.

Example of oil kinematic viscosity calculation for bearing lubrication:

The bearing 6212 operates at a speed of 3500 rpm and a temperature of $+70^{\circ}\text{C}$.

Mean diameter will be:

$$D_m = 0,5(d+D) = 0,5(60+110) = 85 \text{ mm}$$

From the diagram fig. 9, at a temperature of $+70^{\circ}\text{C}$, for a viscosity $\nu_1 = 8 \text{ mm}^2/\text{s}$, the viscosity at $+40^{\circ}\text{C}$ is $20 \text{ mm}^2/\text{s}$ (cSt).

In this case should be selected an oil in accordance with ISO VG 22 with kinematic viscosity limits: $\nu_{\min} = 19,8 \text{ mm}^2/\text{s}$ (cSt) and $\nu_{\max} = 24,2 \text{ mm}^2/\text{s}$ (cSt).

In case of bearing operating at temperatures higher than $+150^{\circ}\text{C}$, an adjustment factor f_t for temperature should be added to the life adjustment factor a_{23} . Adjusted rating life will be:

$$L_{na} = a_1 a_{23} f_t L_{10}$$

Values for the life adjustment factor f_t for temperature are given in table 2.9.

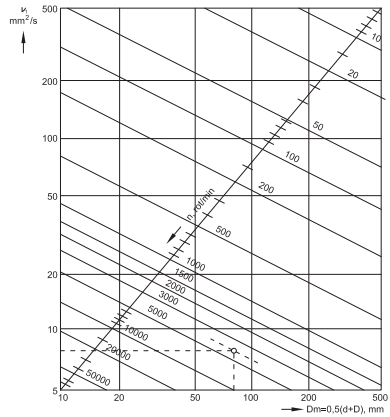

Fig. 8

Values for temperature factor f_t					Table 2.9
Operating temperature $t^{\circ}\text{C}$	150	200	250	300	
f_t	1	0,73	0,42	0,22	

Static load

When the bearing is stationary or rotates at slow movements or very low speeds (lower than 10 rpm), basic static load is not determined by the material fatigue but by permanent deformation caused at the rolling element/raceway contact.

It is also the case of rotating bearings, when they have to sustain heavy shock loads which act during a fraction of their revolution.

Generally, the value of the load may increase up to the value of the basic static load C_0 , without altering the bearing operating properties.

Equivalent static load

Combined static load (radial and axial load acting simultaneously on bearing) must be converted into an equivalent static bearing load. This is defined as the load (radial for radial bearings and axial for thrust bearings) which is applied, and would cause the

same permanent deformation in the bearing as the real load operating over it.

Equivalent static load is obtained from the general equation:

$$P_0 = X_0 F_r + Y_0 F_a, \text{ kN,}$$

where:

- P_0 - equivalent bearing static load, kN,
- F_r - radial component of the heaviest static load, kN,
- F_a - axial component of the heaviest static load, kN,
- X_0 - radial load factor of the bearing,
- Y_0 - axial load factor of the bearing.

Data needed to calculate equivalent static load can be found in text and in bearing tables.

Requisite basic static load rating

When determining bearing size on the basis of the static load, a static safety factor s_0 is used.

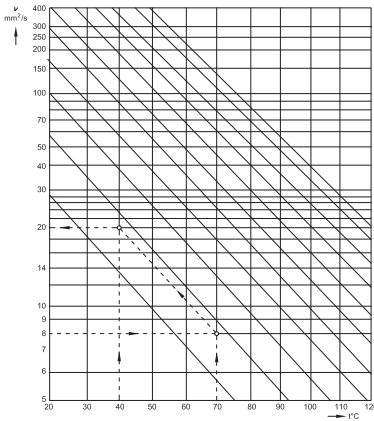

Fig. 9

The requisite basic static load is calculated using the equation:

$$C_{r0} = s_0 P_{r0}, \text{ kN}$$

where:

- C_{r0} - basic static load rating, kN
- s_0 - static safety factor, table 2.11

P_{r0} - equivalent static load, kN.

At high temperatures, life of the material decreases and the static load carrying capacity of bearings is reduced.

For high temperatures, basic static load is calculated using the equation:

$$C_{r0} = f_{ot} s_0 P_{r0}, \text{ kN}$$

The values of factor f_{ot} depending on temperature is given in table 2.10.

Values for temperature factor f_{ot}				
Table 2.10				
Operating temperature $t^\circ\text{C}$	150	200	250	300
f_{ot}	1	0,95	0,85	0,75

Non – rotating bearings

In case of non-rotating bearings, values of static safety factor s_0 , for certain applications are given in table 2.11. These values are also valid for bearings with oscillating movements.

Values for static safety factor s_0	
Table 2.11	
Application	s_0
Variable pitch propeller for aircraft	0,5
Dam gates, flood gates	
Opening bridges	1,5
Crane hooks for:	
*large cranes without additional loads	1,5
*small cranes with additional dynamic loads	1,6

Rotating bearings

In case of fluctuating or oscillating loads and especially when heavy shock loads are acting during a fraction of revolution, it is necessary to check if the bearing has the proper static load carrying capacity. Heavy shock loads, higher than the basic static

bearing load, produce permanent deformations not uniformly distributed on raceway, which influence negatively bearing running.

Generally, heavy shock loads cannot be exactly calculated and in certain cases they produce deformations of bearing housing and consequently an unfavorable load distribution in bearing.

When a bearing rotates under maximum load, raceway becomes uniformly deformed on all its outer surface without any imprint.

For various operating conditions, maximum load acting upon the bearing is calculated with static safety factor s_0 , depending on the vibrations and shock loads.

The values of static safety factor are given in table 2.12.

Values for static safety factor s_0						
Type of operation	Requirements regarding quiet running					
	Unimportant		Normal		High	
	Ball bearings	Roller	Ball bearings	Roller	Ball bearings	Roller
Smooth, vibration-free	0,5	1	1	1,5	2	3
Normal	0,5	1	1	1,5	2	3,5
Heavy shock loads	>1,5	>2,5	>1,5	>3	>2	>4

For bearing with a known equivalent static load, static safety factor s_0 is necessary to be checked using the equation:

$$s_0 = \frac{C_{ro}}{P_{ro}}$$

If the value of s_0 is less than recommended in table 2.12, then a bearing with a higher basic static load carrying capacity should be selected.

Basic static load for a group of bearings

Where more bearings of the same type are

mounted close together to take over a static load, the load magnitude supported by these bearings will be calculated from:

$$C_{0n} = C_{0r} i,$$

where:

C_{0n} - basic static load of the bearing group

C_{0r} - basic static load of the single bearing (catalogue)

i - number of bearings.

Bearing tolerances

Bearing tolerances have been internationally standardized in accordance with ISO 492, ISO 199, ISO 582, ISO 1132.

Bearings are generally manufactured to the tolerance class P0. At request, they can also be manufactured to the tolerance classes P6, P6x, P5, P4 and P2. These bearings are used for special applications, such as very accurate shaft guidance or very high speeds.

The values of the limit deviations for these tolerance classes are given for:

- the overall dimensions of:
 - deep groove ball bearings, angular contact ball bearings, self-aligning ball bearings, spherical roller bearings, cylindrical roller bearings, tapered roller bearings,
 - tapered roller bearing with metric (mm) and inch dimensions,
 - tapered bore bearings,
 - thrust ball bearings, angular contact thrust ball bearings, cylindrical roller thrust bearings, needle roller thrust bearings.
- mounting chamfer.

Symbols

- d - nominal bore diameter or shaft washer nominal bore diameter for thrust bearings
- d_1 - nominal diameter at the theoretical large end of the tapered bore
- d_2 - nominal bore diameter of the shaft washer for double directions thrust bearings
- d_s - deviation of single bore diameter
- d_{psmax} - maximum bore diameter, in a single radial plane
- d_{psmin} - minimum bore diameter, in a single radial plane
- Δd_s - deviation of a single bore diameter $\Delta d_s = d_s - d$
- d_{mp} - mean bore diameter, in a single radial

- plane $d_{mp} = (d_{psmax} + d_{psmin})/2$
- Δd_{mp} - deviation of the mean bore diameter in a single radial plane; or deviation of the mean diameter at the theoretical small end of the tapered bore, in case of tapered bore bearings; or deviation of the mean bore diameter of the shaft washer in a single direction thrust bearings $\Delta d_{mp} = d_{mp} - d$
- Δd_{1mp} - deviation of the mean diameter at the theoretical large end of the tapered bore $\Delta d_{1mp} = d_{1mp} - d$
- Δd_{2mp} - deviation of the mean bore diameter of the shaft washer for a double directions thrust bearings, in a single radial plane
- V_{dp} - bore diameter variation in a single radial plane; or bore diameter variation of the shaft washer in a single radial place, for single thrust bearings $V_{dp} = d_{psmax} - d_{psmin}$
- V_{a2p} - bore diameter variation of the shaft washer for double directions thrust bearings, in a single radial plane
- V_{dmp} - mean bore diameter variation (valid only for cylindrical bore) $V_{dmp} = d_{mpmax} - d_{mpmin}$
- α - nominal half-angle of the tapered bore
- D - nominal outside diameter or housing washer nominal diameter
- D_1 - nominal outside diameter of the outer ring rib
- D_s - single outside diameter maximum
- D_{psmax} - outside diameter in a single radial plane minimum outside diameter in a single radial plane deviation of the single outside diameter $\Delta D_s = D_s - D$
- D_{psmin} - a single radial plane deviation of the single outside diameter $\Delta D_s = D_s - D$
- ΔD_s - mean outside diameter, in a single plane = $(D_{psmax} + D_{psmin})/2$
- D_{mp} - deviation of the mean outside diameter in a single radial plane; or deviation of the mean diameter of housing washer in a single radial plane, for thrust bearings $\Delta D_{mp} = D_{mp} - D$
- ΔD_{mp} - the mean diameter of housing washer in a single radial plane, for thrust bearings $\Delta D_{mp} = D_{mp} - D$
- V_{DP} - outside diameter variation in a single

radial plane; or housing washer diameter variation in a single radial place for double direction thrust bearings $V_{DP} = D_{psmax} - D_{psmin}$

- V_{Dmp} - mean outside diameter variation
- B - nominal width of the inner ring
- B_s - single width of the inner ring
- ΔB_s - inner ring single width deviation
 $\Delta B_s = B_s - B$
- V_{Bs} - inner ring single width variation
- C - nominal width of the outer ring
- C_s - single width of the outer ring
- ΔC_s - deviation of the outer ring single width
 $\Delta C_s = C_s - C$
- V_{Cs} - single width variation of the outer ring
 $V_{Cs} = C_{smax} - C_{smin}$
- T - nominal width of tapered roller bearings
- T_s - single width of tapered roller bearings
- ΔT_s - deviation of the single width of taper roller bearings $\Delta T_s = T_s - T$
- T_1 - nominal width of the inner ring and tapered roller assembly
- T_{1s} - single width of the inner ring and tapered roller assembly
- ΔT_{1s} - deviation of the single width of inner ring and tapered roller assembly
 $\Delta T_{1s} = T_{1s} - T_1$
- T_2 - nominal width of the outer ring assembly
- T_{2s} - single width of the outer ring assembly

- ΔT_{2s} - deviation of the single width of outer ring assembly $\Delta T_{2s} = T_{2s} - T_2$
- K_{ia} - radial runout of assembled bearing inner ring
- K_{ea} - radial runout of assembled bearing outer ring
- S_d - side face runout with reference to bore of the inner ring
- S_D - variation in inclination of outside cylindrical surface to outer ring side face
- S_{ia} - side face runout of assembled inner ring with reference to raceway
- S_{ea} - side face runout of assembled outer ring with reference to raceway
- S_l - thickness variation measured from middle of raceway to back seating face of shaft washer
- S_e - thickness variation measured from middle of raceway to back face of housing washer
- ΔH_s - deviation of mounting height of single direction thrust ball and roller bearings
- ΔH_{1s} - deviation of mounting height of thrust ball bearings with sphered housing washer
- ΔH_{2s} - deviation of mounting height of double direction thrust ball and roller bearings,
- ΔH_{3s} - deviation of mounting height of double direction thrust ball bearings with sphered housing washer.

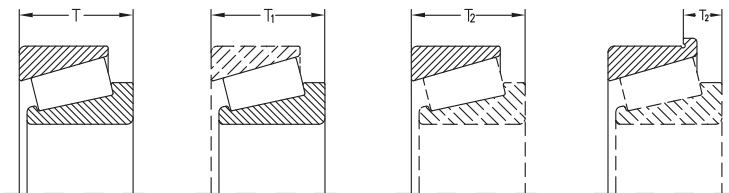
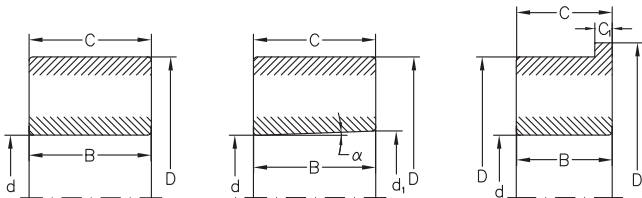

Radial bearings (excepting tapered roller bearings)
Tolerance class P0

Table 3.1												
Inner ring												
d mm		Δd_{mp}		V_{dp}			V_{dmp}	K_{la}	ΔB_s			V_{Bs}
				Diameter series					all	normal	modified ²⁾	
				7,8,9	0,1	2,3,4						
over	up to	high	low	max.	max.	max.	max.	max.	high	low	low	max.
0,6 ¹⁾	2,5	0	-8	10	8	6	6	10	0	-40	-	12
2,5	10	0	-8	10	8	6	6	10	0	-120	-250	15
10	18	0	-8	10	8	6	6	10	0	-120	-250	20
18	30	0	-10	13	10	8	8	13	0	-120	-250	20
30	50	0	-12	15	12	9	9	15	0	-120	-250	20
50	80	0	-15	19	19	11	11	20	0	-150	-380	25
80	120	0	-20	25	25	15	15	25	0	-200	-380	25
120	180	0	-25	31	31	19	19	30	0	-250	-500	30
180	250	0	-30	38	38	23	23	40	0	-300	-500	30
250	315	0	-35	44	44	26	26	50	0	-350	-500	35
315	400	0	-40	50	50	30	30	60	0	-400	-630	40
400	500	0	-45	56	56	34	34	65	0	-450	-	50
500	630	0	-50	63	63	38	38	70	0	-500	-	60
630	800	0	-75	-	-	-	-	80	0	-750	-	70

1) This value included.

2) If refers to isolated bearing ring for paired mounting or sets of 3 or 4 bearing.

Table 3.2												
Outer ring												
D mm		ΔD_{mp}		$V_{Dp}^{3)}$				$V_{Dmp}^{3)}$	K_{ea}	ΔC_s		V_{Cs}
				Open bearings			Shielded					
				Diameter series			Bearings ²⁾					
				7,8,9	0,1	2,3,4	2,3,4					
over	up to	high	low	max.	max.	max.	max.	max.	max.	high	low	max.
2,5 ¹⁾	6	0	-8	10	8	6	10	6	15	Values are identical to ΔB_s and V_s for the inner ring of the same bearing.		
6	18	0	-8	10	8	6	10	6	15			
18	30	0	-9	12	9	7	12	7	15			
30	50	0	-11	14	11	8	16	8	20			
50	80	0	-13	16	13	10	20	10	25			
80	120	0	-15	19	19	11	26	11	35			
120	150	0	-18	23	23	14	30	14	40			
150	180	0	-25	31	31	19	38	19	45			
180	250	0	-30	38	38	23	-	23	50			
250	315	0	-35	44	44	26	-	26	60			
315	400	0	-40	50	50	30	-	30	70			
400	500	0	-45	56	56	34	-	34	80			
500	630	0	-50	63	63	38	-	38	100			
630	800	0	-75	94	94	55	-	55	120			
800	1000	0	-100	125	125	75	-	75	140			

1) This value included.

2) For bearings of diameter series 7,8,9,0, and 1 values are not indicated.

3) Values are valid before mounting the snap ring or shields or after their dismounting.

Tolerance class P6

Deviations in μm													Table 3.3
Inner ring													
d mm		Δd_{mp}		V_{dp}			V_{dmp}	K_{ia}	ΔB_s			V_{Bs}	
				Diameter series					all	normal	modified ²⁾		
				7,8,9	0,1	2,3,4							
over	up to	high	low	max.	max.	max.	max.	max.	high	low	low	max.	
0	2,5	0	-7	9	7	5	5	5	0	-40	-	12	
2,5	10	0	-7	9	7	5	5	6	0	-120	-250	15	
10	18	0	-7	9	7	5	5	7	0	-120	-250	20	
18	30	0	-8	10	8	6	6	8	0	-120	-250	20	
30	50	0	-10	13	10	8	8	10	0	-120	-250	20	
50	80	0	-12	15	15	9	9	10	0	-150	-380	25	
80	120	0	-15	19	19	11	11	13	0	-200	-380	25	
120	180	0	-18	23	23	14	14	18	0	-250	-500	30	
180	250	0	-22	28	28	17	17	20	0	-300	-500	30	
250	315	0	-25	31	31	19	19	25	0	-350	-500	35	
315	400	0	-30	38	38	23	23	30	0	-400	-630	40	
400	500	0	-35	44	44	26	26	35	0	-450	-	45	
500	630	0	-40	50	50	30	30	40	0	-500	-	50	

1) This value included.

2) It refers to isolated bearing ring for paired mounting or sets of 3 or 4 bearing.

Deviations in μm													Table 3.4
Outer ring													
D mm		ΔD_{mp}		$V_{dp}^{3)}$				$V_{Dmp}^{3)}$	K_{ea}	ΔC_s			V_{cs}
				Open bearings			Shielded Bearings ²⁾			high	low	max.	
				Diameter series									
				7,8,9	0,1	2,3,4	2,3,4						
over	up to	high	low	max.	max.	max.	max.	max.	high	low	max.		
2,5 ¹⁾	6	0	-7	9	7	5	9	5	8	Values are identical to ΔB_s and V_{Bs} for the inner ring			
6	18	0	-7	9	7	5	9	5	8				
18	30	0	-8	10	8	6	10	6	9				
30	50	0	-9	11	9	7	13	7	10				
50	80	0	-11	14	11	8	16	8	13				
80	120	0	-13	16	16	10	20	10	18				
120	150	0	-15	19	19	11	25	11	20				
150	180	0	-18	23	23	14	30	14	23				
180	250	0	-20	25	25	15	-	15	25				
250	315	0	-25	31	31	19	-	19	30				
315	400	0	-28	35	35	21	-	21	35				
400	500	0	-33	41	41	25	-	25	40				
500	630	0	-38	48	48	29	-	29	50				
630	800	0	-45	56	56	34	-	34	60				
800	1000	0	-60	75	75	45	-	45	75				

1) This value included.

2) For bearings of diameter series 7,8 and 9 values are not indicated.

3) Values are valid before mounting the snap ring or shields or after their dismounting.

Tolerance class P5

Deviations in μm													Table 3.5
Inner ring													
d mm		Δd_{mp}		V_{dp}		V_{dmp}	K_{ia}	S_d	$S_{ia}^{2)}$	ΔB_s			V_{Bs}
				Diameter series						all	normal	modified ³⁾	
				7,8,9	0,1,2,3,4								
over	up to	high	low	max.	max.	max.	max.	max.	max.	high	low	low	max.
0,6 ¹⁾	2,5	0	-5	5	4	3	4	7	7	0	-40	-250	5
2,5	10	0	-5	5	4	3	4	7	7	0	-40	-250	5
10	18	0	-5	5	4	3	4	7	7	0	-80	-250	5
18	30	0	-6	6	5	3	4	8	8	0	-120	-250	5
30	50	0	-8	8	6	4	5	8	8	0	-120	-250	5
50	80	0	-9	9	7	5	5	8	8	0	-150	-250	6
80	120	0	-10	10	8	5	6	9	9	0	-200	-380	7
120	180	0	-13	13	10	7	8	10	10	0	-250	-380	8
180	250	0	-15	15	12	8	10	11	13	0	-300	-500	10
250	315	0	-18	18	14	9	13	13	15	0	-350	-500	13
315	400	0	-25	25	18	12	15	15	20	0	-400	-630	15

1) This value included.

2) Applies only to ball bearings.

3) If refers to single bearing ring for paired mounting or sets of 3 or 4 bearing.

Deviations in μm													Table 3.6
Outer ring													
D mm		ΔD_{mp}		$V_{Dp}^{2)}$		$V_{Dmp}^{3)}$	K_{oa}	S_D	$S_{oa}^{3)}$	ΔC_s		V_{Cs}	
				7,8,9	0,1,2,3,4					high	low		
over	up to	high	low	max.	max.	max.	max.	max.	max.	high	low	max.	
2,5 ¹⁾	6	0	-5	5	4	3	5	8	8	Identical to ΔB_s and V_{Bs} for the inner ring		5	
6	18	0	-5	5	4	3	5	8	8				5
18	30	0	-6	6	5	3	6	8	8				5
30	50	0	-7	7	5	4	7	8	8				5
50	80	0	-9	9	7	5	8	8	10				6
80	120	0	-10	10	8	5	10	9	11				8
120	150	0	-11	11	8	6	11	10	13				8
150	180	0	-13	13	10	7	13	10	14				8
180	250	0	-15	15	11	8	15	11	15				10
250	315	0	-18	18	14	9	18	13	18				11
315	400	0	-20	20	15	10	20	13	20				13
400	500	0	-23	23	17	12	23	15	23				15
500	630	0	-28	28	21	14	25	18	25				18
630	800	0	-35	35	26	18	30	20	30				20

1) This value included.

2) Do not apply to shielded bearings.

3) Apply to ball bearings.

Tolerance class P4

Inner ring													Table 3.7
Deviations in μm													
d mm		$\Delta d_{mp}, \Delta d_s^{2)}$		V_{dp}		V_{dmp}	K_{Ia}	S_d	$S_{Ia}^{3)}$	ΔB_s			V_{Bs}
				Diameter series						all	normal	modified ⁴⁾	
				7,8,9	0,1,2,3,4								
over	up to	high	low	max.	max.	max.	max.	max.	max.	high	low	low	max.
0,6 ¹⁾	2,5	0	-4	4	3	2	2,5	3	3	0	-40	-250	2,5
2.5	10	0	-4	4	3	2	2,5	3	3	0	-40	-250	2,5
10	18	0	-4	4	3	2	2,5	3	3	0	-80	-250	2,5
18	30	0	-5	5	4	2,5	3	4	4	0	-120	-250	2,5
30	50	0	-6	6	5	3	4	4	4	0	-120	-250	3
50	80	0	-7	7	5	3,5	4	5	5	0	-150	-250	4
80	120	0	-8	8	6	4	5	5	5	0	-200	-380	4
120	180	0	-10	10	8	5	6	6	7	0	-250	-380	5
180	250	0	-12	12	9	6	8	7	8	0	-300	-500	6

1) This value included.

2) Apply only to bearings of diameter series 0,1,2,3,4.

3) Apply only to ball bearings.

4) It refers to single bearing ring for paired mounting or sets of 3 or 4 bearing.

Outer ring													Table 3.8
Deviations in μm													
D mm		$\Delta D_{mp}, \Delta D_s^{2)}$		$V_{Dp}^{3)}$		V_{Dmp}	K_{ea}	S_D	$S_{ea}^{4)}$	ΔC_s		V_{Cs}	
				Diameter series						high	low		
				7,8,9	0,1,2,3,4								
over	up to	high	low	max.	max.	max.	max.	max.	max.	high	low	max.	
2,5 ¹⁾	6	0	-4	4	3	2	3	4	5	Identical to ΔB_s and V_{Bs} for the inner ring		2,5	
6	18	0	-4	4	3	2	3	4	5			2,5	
18	30	0	-5	5	4	2,5	4	4	5			2,5	
30	50	0	-6	6	5	3	5	4	5			2,5	
50	80	0	-7	7	5	3,5	5	4	5			3	
80	120	0	-8	8	6	4	6	5	6			4	
120	150	0	-9	9	7	5	7	5	7			5	
150	180	0	-10	10	8	5	8	5	8			5	
180	250	0	-11	11	8	6	10	7	10			7	
250	315	0	-13	13	10	7	11	8	10			7	
315	400	0	-15	15	11	8	13	10	13	8			

1) This value included.

2) Apply to bearings of diameter series 0,1,2,3 and 4.

3) Do not apply to sealed and shielded bearings.

4) Apply only to ball bearings.

Tolerance class P2

Deviations in μm												Inner ring		Table 3.9
d mm		$\Delta d_{mp}, \Delta d_s^{2)}$		V_{dp}	V_{dmp}	K_{la}	S_d	$S_{la}^{2)}$ all	ΔB_s		V_{Bs}			
									high	low				
over	up to	high	low	max.	max.	max.	max.	max.	high	low	max.			
0,6 ¹⁾	2,5	0	-2,5	2,5	1,5	1,5	1,5	1,5	0	-40	1,5			
2,5	10	0	-2,5	2,5	1,5	1,5	1,5	1,5	0	-40	1,5			
10	18	0	-2,5	2,5	1,5	1,5	1,5	1,5	0	-80	1,5			
18	30	0	-2,5	2,5	1,5	2,5	1,5	2,5	0	-120	1,5			
30	50	0	-2,5	2,5	1,5	2,5	1,5	2,5	0	-120	1,5			
50	80	0	-4	4	2	2,5	1,5	2,5	0	-150	1,5			
80	120	0	-5	5	2,5	2,5	2,5	2,5	0	-200	2,5			
120	150	0	-7	7	3,5	2,5	2,5	2,5	0	-250	2,5			
150	180	0	-7	7	3,5	5	4	5	0	-300	4			
180	250	0	-8	8	4	5	5	5	0	-350	5			

- 1) This value included.
2) Apply only to ball bearings.

Deviations in μm												Outer ring		Table 3.10
D mm		$\Delta D_{mp}, \Delta D_s$		V_{Dp}	V_{Dmp}	K_{ea}	$S_D^{2),3)}$	$S_{ea}^{3)}$	ΔC_s		V_{Cs}			
									high	low				
over	up to	high	low	max.	max.	max.	max.	max.	high	low	max.			
2,5 ¹⁾	6	0	-2,5	2,5	1,5	1,5	1,5	1,5	Identical to ΔB_s for the inner ring		1,5			
6	18	0	-2,5	2,5	1,5	1,5	1,5	1,5		1,5				
18	30	0	-4	4	2	2,5	1,5	2,5		1,5				
30	50	0	-4	4	2	2,5	1,5	2,5		1,5				
50	80	0	-4	4	2	4	1,5	4		1,5				
80	120	0	-5	5	2,5	5	2,5	5		2,5				
120	150	0	-5	5	2,5	5	2,5	5		2,5				
150	180	0	-7	7	3,5	5	2,5	5		2,5				
180	250	0	-8	8	4	7	4	7		4				
250	315	0	-8	8	4	7	5	7		5				
315	400	0	-10	10	5	8	7	8	7					

- 1) This value included.
2) Do not apply to bearings with rib on the outer ring.
3) Apply only to ball bearings

Tolerance class SP

Deviations in μm															
Inner ring															
d mm		Cylindrical bore			Tapered bore					ΔB_s		V_{Bs}	K_{Ia}	S_d	S_{Ia}
		Δd_{mp}	Δd_s	V_{dp}	Δd_s		V_{dp}	Δd_{1mp}	$-\Delta d_{mp}$						
over	up to	low	high	max.	low	high	max.	low	high	low	high	max.	max.	max.	max.
-	18	-5	0	3	-	-	-	-	-	-100	0	5	3	8	8
18	30	-6	0	3	0	+10	3	0	+4	-100	0	5	3	8	8
30	50	-8	0	4	0	+12	4	0	+4	-120	0	5	4	8	8
50	80	-9	0	5	0	+15	5	0	+5	-150	0	6	4	8	8
80	120	-10	0	5	0	+20	5	0	+6	-200	0	7	5	9	9
120	180	-13	0	7	0	+25	7	0	+8	-250	0	8	6	10	10
180	250	-15	0	8	0	+30	8	0	+10	-300	0	10	8	11	13
250	315	-18	0	9	0	+35	9	0	+12	-350	0	13	10	13	15
315	400	-23	0	12	0	+40	12	0	+13	-400	0	15	12	15	20

Table 3.11

Deviations in μm															
Outer ring															
D mm		$\Delta D_{mp}, \Delta D_s$		V_{Dp}	K_{ea}	S_D	S_{ea}	ΔC_s	V_{Cs}						
		low	high							max.	max.	max.	max.		
over	up to	low	high	max.	max.	max.	max.	Identical to ΔB_s and V_{Bs} for the inner ring							
30	50	-7	0	4	5	8	8								
50	80	-9	0	5	5	8	10								
80	120	-10	0	5	6	9	11								
120	150	-11	0	6	7	10	13								
150	180	-13	0	7	8	10	14								
180	250	-15	0	8	10	11	15								
250	315	-18	0	9	11	13	18								
315	400	-20	0	10	13	13	20								
400	500	-23	0	12	15	15	23								

Table 3.12

Tolerance class UP

Deviations in μm		Inner ring											Table 3.13		
d mm		Cylindrical bore			Tapered bore					ΔB_s		V_{Bs}	K_{Ia}	S_d	S_{Ia}
		$\Delta d_{mp}, \Delta d_s$	V_{dp}	Δd_s		V_{dp}	$\Delta d_{imp}, -\Delta d_{mp}$								
over	up to	low	high	max.	low	high	max.	low	high	low	high	max.	max.	max.	max.
-	18	-4	0	2	0	-	-	-	-	-25	0	1,5	1,5	2	3
18	30	-5	0	3	0	+6	3	0	+2	-25	0	1,5	1,5	3	3
30	50	-6	0	3	0	+8	3	0	+3	-30	0	2	2	3	3
50	80	-7	0	4	0	+9	4	0	+3	-40	0	3	2	4	3
80	120	-8	0	4	0	+10	4	0	+4	-50	0	3	3	4	4
120	180	-10	0	5	0	+13	5	0	+5	-60	0	4	3	5	6
180	250	-12	0	6	0	+15	6	0	+7	-75	0	5	4	6	7
250	315	-18	0	9	0	+18	9	0	+8	-90	0	6	5	6	8
315	400	-23	0	12	0	+23	12	0	+9	-100	0	8	6	8	9

Deviations in μm		Outer ring								Table 3.14	
D mm		$\Delta D_{mp}, \Delta D_s$		V_{Dp}	K_{ea}	S_D	S_{ea}	ΔC_s	V_{Cs}		
over	up to	low	high	max.	max.	max.	max.	high	max.		
30	50	-5	0	3	3	2	4	Identical to ΔB_s and V_{Bs} for the inner ring	max.		
50	80	-6	0	3	3	2	4				
80	120	-7	0	4	3	3	5				
120	150	-8	0	4	4	3	6				
150	180	-9	0	5	4	3	7				
180	250	-10	0	5	5	4	9				
250	315	-12	0	6	6	4	9				
315	400	-14	0	7	7	5	12				
400	500	-23	0	12	8	-	12				

3.2 Tapered Roller Bearings Tolerance class P0 and P0X

Deviations in μm							Inner ring		Table 3.15	
d mm		Δd_{mp}		V_{dp}	V_{dmp}	K_{ia}				
over	up to	high	low	max.	max.	max.				
10 ¹⁾	18	0	-12	12	9	15				
18	30	0	-12	12	9	18				
30	50	0	-12	12	9	20				
50	80	0	-15	15	11	25				
80	120	0	-20	20	15	30				
120	180	0	-25	25	19	35				
180	250	0	-30	30	23	50				
250	315	0	-35	35	26	60				
315	400	0	-40	40	30	70				

1) This value included.

Deviations in μm							Outer ring		Table 3.16	
D mm		ΔD_{mp}		V_{Dp}	V_{Dmp}	K_{ea}				
over	up to	high	low	max.	max.	max.				
18 ¹⁾	30	0	-12	12	9	18				
30	50	0	-14	14	11	20				
50	80	0	-16	16	12	25				
80	120	0	-18	18	14	35				
120	150	0	-20	20	15	40				
150	180	0	-25	25	19	45				
180	250	0	-30	30	23	50				
250	315	0	-35	35	26	60				
315	400	0	-40	40	30	70				
400	500	0	-45	45	34	80				

1) This value included.

Note: Limit deviations of the diameter D1 of the outer ring rib for bearings with ribs are in accordance with tolerance class h9.

Tolerance class P0

Deviations in μm										Inner and outer ring		Table 3.17	
d mm		$\Delta B_s, \Delta C_s$		ΔT_s		ΔT_{1s}		ΔT_{2s}					
over	up to	high	low	high	low	high	low	high	low				
10 ¹⁾	18	0	-120	+200	0	+100	0	+100	0				
18	30	0	-120	+200	0	+100	0	+100	0				
30	50	0	-120	+200	0	+100	0	+100	0				
50	80	0	-150	+200	0	+100	0	+100	0				
80	120	0	-200	+200	-200	+100	-100	+100	-100				
120	180	0	-250	+350	-250	+150	-150	+200	-100				
180	250	0	-300	+350	-250	+150	-150	+200	-100				
250	315	0	-350	+350	-250	+150	-150	+200	-100				
315	400	0	-400	+400	-400	+200	-200	+200	-200				

1) This value included.

Tolerance class P6X
Inner and outer ring

Diameter limit deviations and radial runout of the inner and outer ring of this tolerance class are the same as those of tolerance class P₀

Deviations in μm												Table 3.18
d mm		ΔB_s		ΔC_s		ΔT_s		ΔT_{1s}		ΔT_{2s}		
over	up to	high	low	high	low	high	low	high	low	high	low	
10¹⁾	18	0	-50	0	-100	+100	0	+50	0	+50	0	
18	30	0	-50	0	-100	+100	0	+50	0	+50	0	
30	50	0	-50	0	-100	+100	0	+50	0	+50	0	
50	80	0	-50	0	-100	+100	0	+50	0	+50	0	
80	120	0	-50	0	-100	+100	0	+50	0	+50	0	
120	180	0	-50	0	-100	+150	0	+50	0	+100	0	
180	250	0	-50	0	-100	+150	0	+50	0	+100	0	
250	315	0	-50	0	-100	+200	0	+100	0	+100	0	
315	400	0	-50	0	-100	+200	0	+100	0	+100	0	

1) This value included.

Tolerance class P5

Deviations in μm												Table 3.19
Inner ring												
d mm		Δd_{mp}		V_{dp}	V_{dmp}	K_{Ia}	S_d	ΔB_s		ΔT_s		
over	up to	high	low	max.	max.	max.	max.	high	low	high	low	
10¹⁾	18	0	-7	5	5	5	7	0	-200	+200	-200	
18	30	0	-8	6	5	5	8	0	-200	+200	-200	
30	50	0	-10	8	5	6	8	0	-240	+200	-200	
50	80	0	-12	9	6	7	8	0	-300	+200	-200	
80	120	0	-15	11	8	8	9	0	-400	+200	-200	
120	180	0	-18	14	9	11	10	0	-500	+350	-250	
180	250	0	-22	17	11	13	11	0	-600	+350	-250	

1) This value included.

Deviations in μm												Table 3.20
Outer ring												
D mm		ΔD_{mp}		V_{Dp}	V_{Dmp}	K_{Ea}	S_D	ΔC_s				
over	up to	high	low	max.	max.	max.	max.	high		low		
18¹⁾	30	0	-8	6	5	6	8	Identical with ΔB_s for the inner ring.				
30	50	0	-9	7	5	7	8					
50	80	0	-11	8	6	8	8					
80	120	0	-13	10	7	10	9					
120	150	0	-15	11	8	11	10					
150	180	0	-18	14	9	13	10					
180	250	0	-20	15	10	15	11					
250	315	0	-25	19	13	18	13					
315	400	0	-28	22	14	20	15					

1) This value included.

Tolerance class P4

Deviations in μm												Inner ring		Table 3.21
d mm		$\Delta d_{mp}, \Delta d_s$		V_{dp}	V_{dmp}	K_{ia}	S_d	S_{ia}	ΔB_s		ΔT_s			
over	up to	high	low	max.	max.	max.	max.	max.	high	low	high	low		
10 ¹⁾	18	0	-5	4	4	3	3	3	0	-200	+200	-200		
18	30	0	-6	5	4	3	4	4	0	-200	+200	-200		
30	50	0	-8	6	5	4	4	4	0	-240	+200	-200		
50	80	0	-9	7	5	4	5	4	0	-300	+200	-200		
80	120	0	-10	8	5	5	5	5	0	-400	+200	-200		
120	180	0	-13	10	7	6	6	7	0	-500	+350	-250		
180	250	0	-15	11	8	8	7	8	0	-600	+350	-250		

1) This value included.

Deviations in μm												Outer ring		Table 3.22
D mm		$\Delta D_{mp}, \Delta D_s$		V_{Dp}	V_{Dmp}	K_{ea}	S_D	S_{ea}	ΔC_s					
over	up to	high	low	max.	max.	max.	max.	max.	high	low				
18 ¹⁾	30	0	-6	5	4	4	4	5	Identical with ΔB_s for the inner ring.					
30	50	0	-7	5	5	5	4	5						
50	80	0	-9	7	5	5	4	5						
80	120	0	-10	8	5	6	5	6						
120	150	0	-11	8	6	7	5	7						
150	180	0	-13	10	7	8	5	8						
180	250	0	-15	11	8	10	7	10						
250	315	0	-18	14	9	11	8	10						
315	400	0	-20	15	10	13	10	13						

1) This value included.

Note: Limit deviations of the diameter D, of the outer ring rib for bearings with ribs are in accordance with tolerance class h9.

Tapered roller bearings, inch-metric sizes (AFBMA)

Inner ring- Δd_{mp}											
Tolerances classes											
d mm		4		2		3		0		00	
over	up to	high	low	high	low	high	low	high	low	high	low
-	76,2	+13	0	+13	0	+13	0	+13	0	+8	0
76,2	266,7	+25	0	+25	0	+13	0	+13	0	+8	0
266,7	304,8	+25	0	+25	0	+13	0	+13	0	-	-

Table 3.23

Outer ring- ΔD_{mp}											
Tolerances classes											
D mm		4		2		3		0		00	
over	up to	high	low	high	low	high	low	high	low	high	low
-	266,7	+25	0	+25	0	+13	0	+13	0	+8	0
266,7	304,8	+25	0	+25	0	+13	0	+13	0	-	-
304,8	609,6	+51	0	+51	0	+25	0	-	-	-	-

Table 3.24

Assembled bearing- K_{ia}, K_{ea}						
Deviations in μm						
D mm		Tolerances classes				
over	up to	4	2	3	0	00
		max.	max.	max.	max.	max.
-	266,7	51	38	8	4	2
266,7	304,8	51	38	8	4	-
304,8	609,6	51	38	18	-	-

Table 3.25

Tapered roller bearings, inch-metric sizes (AFBMA)

Assembled bearing - ΔT_s												Table 3.26
Tolerances classes												
d mm		4		2		3		0		00		
over	up to	high	low	high	low	high	low	high	low	high	low	
-	101,6	+203	-	+203	0	+203	-203	+203	-203	+203	-203	
101,6	266,7	+356	-254	+203	0	+203	-203	+203	-203	+203	-203	
266,7	304,8	+356	-254	+203	0	+203	-203	+203	-203	-	-	

Inner ring+rollers assembly, with outer ring gauge - Δ_{T1s}												Table 3.27
Tolerances classes												
d mm		4		2		3		0		00		
over	up to	high	low	high	low	high	low	high	low	high	low	
-	101,6	+102	0	+102	0	+102	-102	+102	-102	+102	-102	
101,6	304,8	+152	-152	+102	0	+102	-102	+102	-102	+102	-102	

Outer ring with gauge inner ring assembly - ΔT_{2s}												Table 3.28
Tolerances classes												
d mm		4		2		3		0		00		
over	up to	high	low	high	low	high	low	high	low	high	low	
-	101,6	+102	0	+102	0	+102	-102	+102	-102	+102	-102	
101,6	304,8	+203	-102	+102	0	+102	-102	+102	-102	+102	-102	

Tapered bore bearings

Taper 1:12												Table 3.29
Deviations μm												
d mm		Normal tolerance class, P6						Tolerance class P5				
		Δd_{mp}		$Vd_p^{1)}$		$\Delta d_{1mp} - \Delta d_{mp/2}$		Δ_{dmp}		$Vd_p^{1)}$		$\Delta d_{1mp} - \Delta d_{mp}$
over	up to	high	low	max.	high	low	high	low	max.	high	low	
18	30	+21	0	13	+21	0	+13	0	13	+13	0	
30	50	+25	0	15	+25	0	+16	0	15	+16	0	
50	80	+30	0	19	+30	0	+19	0	19	+19	0	
80	120	+35	0	25	+35	0	+22	0	22	+22	0	
120	180	+40	0	31	+40	0	+25	0	25	+25	0	
180	250	+46	0	38	+46	0	+29	0	29	+29	0	
250	315	+52	0	44	+52	0	+32	0	32	+32	0	
315	400	+57	0	50	+57	0	+36	0	36	+36	0	

1) Applies in all single radial planes of the bore

Deviations in μm		Taper 1:30					Table 3.30	
d mm		Normal tolerance class						
		Δd_{mp}		$V_{dp}^{1)}$	$\Delta d_{1mp} - \Delta d_{mp}$			
over	up to	high	low	max.	high	low		
80	120	+20	0	25	+40	0		
120	180	+25	0	31	+50	0		
180	250	+30	0	38	+55	0		
250	315	+35	0	44	+60	0		
315	400	+40	0	50	+65	0		

1) Applies in all singular planes

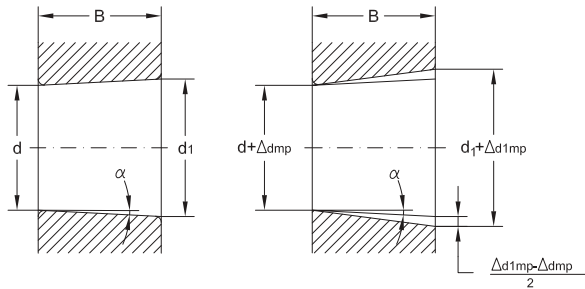

Tapered bore
Half angle of taper, α

$\alpha = 2^{\circ}23'9,4''$ (taper 1:12)
 $\alpha = 0^{\circ}57'17,4''$ (taper 1:30)

Nominal diameter, d , at the theoretical large end of bore

$$d_1 = d + \frac{1}{12} B \text{ (taper 1:12)}$$

$$d_1 = d + \frac{1}{30} B \text{ (taper 1:30)}$$

Deviations in μm		Shaft washer						Table 3.31	
d and d_2 mm		P0;P6;P5			P4;P2				
		Δd_{2mp}		V_{dp} V_{d2p}	Δd_{mp}		V_{dp} V_{d2p}		
over	up to	high	low	max.	high	low	max.		
-	18	0	-8	6	0	-7	5		
18	30	0	-10	8	0	-8	6		
30	50	0	-12	9	0	-10	8		
50	80	0	-15	11	0	-12	9		
80	120	0	-20	15	0	-15	11		
120	180	0	-25	19	0	-18	14		
180	250	0	-30	23	0	-22	17		
250	315	0	-35	26	0	-25	19		
315	400	0	-40	30	0	-30	23		
400	500	0	-45	34	0	-35	26		
500	630	0	-50	38	0	-40	30		

Deviations in μm		Housing washer						Table 3.32
D mm		P0;P6;P5			P4;P2			
		ΔD_{mp}		V_{Dp}	ΔD_{mp}		V_{Dp}	
over	up to	high	low	max.	high	low	max.	
10 ¹⁾	18	0	-11	8	0	-7	5	
18	30	0	-13	10	0	-8	6	
30	50	0	-16	12	0	-9	7	
50	80	0	-19	14	0	-11	8	
80	120	0	-22	17	0	-13	10	
120	180	0	-25	19	0	-15	11	
180	250	0	-30	23	0	-20	15	
250	315	0	-35	26	0	-25	19	
315	400	0	-40	30	0	-28	21	
400	500	0	-45	34	0	-33	25	
500	630	0	-50	38	0	-38	29	
630	800	0	-75	55	0	-45	34	

1) This value included.

Deviations in μm		Variation of shaft washer and housing washer thickness					Table 3.33
d* mm		S_i					S_e
		P0	P6	P5	P4	P2	P0,P6,P5,P4,P2
over	up to	max.	max.	max.	max.	max.	Identical to S_i for the shaft washer
-	18	10	5	3	2	1	
18	30	10	5	3	2	1,2	
30	50	10	6	3	2	1,5	
50	80	10	7	4	3	2	
80	120	15	8	4	3	2	
120	180	15	9	5	4	3	
180	250	20	10	5	4	3	
250	315	25	13	7	5	4	
315	400	30	15	7	5	4	
400	500	30	18	9	6	-	
500	630	35	21	11	7	-	

* The values of S_i and S_e admitted for double direction thrust bearings are equal to the corresponding values of the single direction thrust bearings and are functions of the bore diameter d, of the single direction bearings.

Assembled thrust bearings Bearing height

Deviations in μm		Table 3.34			
d mm		ΔH_s		ΔH_{2s}	
over	up to	high	low	high	low
18	30	+20	-250	+150	-400
30	50	+20	-250	+150	-400
50	80	+20	-300	+150	-500
80	120	+25	-300	+200	-500
120	180	+25	-400	+200	-600
180	250	+30	-400	+250	-600
250	315	+40	-400	+350	-700
315	400	+40	-500	+350	-700
400	500	+50	-500	+400	-900
500	600	+60	-600	+500	-1100

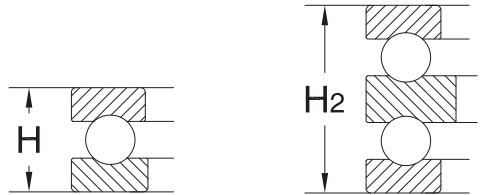

Mounting chamfer dimensions tolerances

Symbols:

- r_1, r_3 - chamfer dimension in radial direction,
- r_2, r_4 - chamfer dimension in axial direction,
- $r_{s\ min}$ - general symbol for minimum limit of r_1, r_2, r_3, r_4 ,
- $r_{1s\ max}, r_{3s\ max}$ - maximum dimension in radial direction,
- $r_{2s\ max}, r_{4s\ max}$ - maximum dimension in axial direction.

Mounting chamfer dimension limits for radial and thrust bearings					
Values in mm Table 3.35					
$r_{s\ min}$	d		Radial bearings		Thrust bearings
	over	up to	r_{1s}, r_{3s} max.	r_{2s}, r_{4s} max.	r_{1s}, r_{2s} max.
0,1	-	-	0,2	0,4	0,2
0,15	-	-	0,3	0,6	0,3
0,2	-	-	0,5	0,8	0,5
0,3	-	40	0,6	1	0,8
	40	-	0,8	1	0,8
0,6	-	40	1	2	1,5
	40	-	1,3	2	1,5
1	-	50	1,5	3	2,2
	50	-	1,9	3	2,2
1,1	-	120	2	3,5	2,7
	120	-	2,5	4	2,7
1,5	-	120	2,3	4	3,5
	120	-	3	5	3,5
2	-	80	3	4,5	4
	80	220	3,5	5	4
2,1	-	220	3,8	6	4
	-	100	3,8	6	-
2,5	-	280	4	6,5	4,5
	280	-	4,5	7	4,5
3	100	280	4,5	6	-
	280	-	5	7	-
4	-	280	5	8	5,5
	280	-	5,5	8	5,5
5	-	-	6,5	9	6,5
6	-	-	8	10	8
7,5	-	-	10	13	10
12,5	-	-	12,5	17	12,5

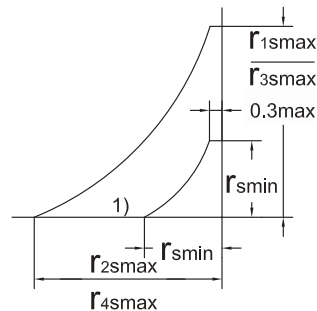
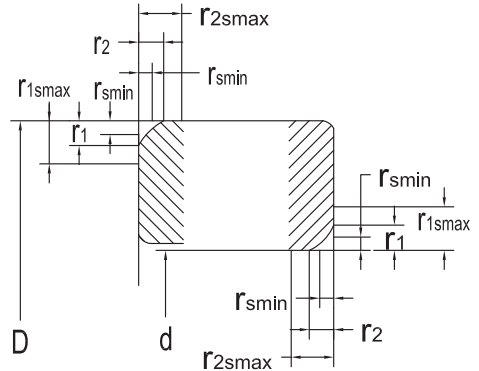
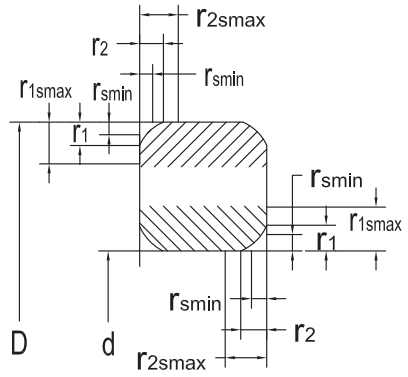

1) Only for $d < 30$ mm

Mounting chamfer dimension limits for tapered roller bearings

Values in mm Tab 3.36

r_{smin}	d, D		r_{1s}, r_{3s}	r_{2s}, r_{4s}
	over	incl.	max.	max.
0,3	-	40	0,7	1,4
	40	-	0,9	1,6
0,6	-	40	1,1	1,7
	40	-	1,3	2
1	-	50	1,6	2,5
	50	-	1,9	3
1,5	-	120	2,3	3
	120	250	2,8	3,5
	250	-	3,5	4
2	-	120	2,8	4
	120	250	3,5	4,5
	250	-	4	5
2,5	-	120	3,5	5
	120	250	4	5,5
	250	-	4,5	6
3	-	120	4	5,5
	120	250	4,5	6,5
	250	400	5	7
	400	-	5,5	7,5
4	-	120	5	7
	120	250	5,5	7,5
	250	400	6	8
	400	-	6,5	8,5
5	-	180	6,5	8
	180	-	7,5	9
6	-	180	7,5	10
	180	-	9	11

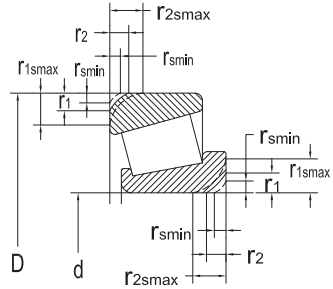

Mounting chamfer dimension limits for tapered roller bearings

Values in mm (inch-metric sizes) Table 3.37

Minimum values	Inner ring Nominal bore diameter		Maximum values		Outer ring Nominal outer diameter D		Maximum	
	over	up to	r_{1smax}	r_{2smax}	over	up to	r_{3smax}	r_{4smax}
See bearing tables	-	50,8	$r_{smin}+0,4$	$r_{smin}+0,9$	-	101,6	$r_{smin}+0,6$	$r_{smin}+1,1$
	50,8	101,6	$r_{smin}+0,5$	$r_{smin}+1,3$	101,6	168,3	$r_{smin}+0,6$	$r_{smin}+1,2$
	101,6	254	$r_{smin}+0,6$	$r_{smin}+1,8$	168,3	266,7	$r_{smin}+0,8$	$r_{smin}+1,4$
					266,7	355,6	$r_{smin}+1,7$	$r_{smin}+1,7$
1	254	-	1,9	3	355,6	-	1,9	3
1,5	254	-	3,5	4	355,6	-	3,5	4
2,5	254	-	4,5	6	355,6	-	4,5	6
3	254	-	5,5	7,5	355,6	-	5,5	7,5
3,3	254	-	6,5	9	355,6	-	6,5	9
3,5	254	-	6,5	9	355,6	-	6,5	9
6,4	254	-	125	17	355,6	-	12,5	17
8,5	254	-	15	19	355,6	-	15	19

Bearing applications

Radial and axial loads in bearing units can be transmitted by locating and non-locating bearings.

A locating bearing is generally used for medium and large-sized shafts that can reach high temperatures during operation. It has to support radially the shaft assembly and to locate it axially in both directions.

A non-locating bearing supports the shaft assembly only radially. It also allows axial displacement in relation to the housing to take place so that additional axial loading is avoided.

Axial displacement can take place either in the housing bore seating or in the bearing itself.

In case the shaft is supported by more than two bearings, only one of them will be a locating bearing and it will be the one with the lightest radial load.

In case of small-sized shafts, two non-locating bearings with limited displacement can be used. Each of them can accommodate axial loads in a single direction, having thus mutual location.

Fig. 4.1 shows a few of the most representative applications of locating and non-locating bearings, as follows:

a) The locating bearing is a single row deep groove ball bearing and the non-locating one is a cylindrical roller bearing with both rings tightly fitted on the shaft and into the housing, respectively.

b) Both bearings are supported by spherical roller bearings. The locating bearing is tightly fitted both on the shaft and into the housing. The non-locating bearing has the outer ring mounted with clearance into the housing and thus allows axial displacement in both directions.

c) The locating bearing consists of a cylindrical roller bearing, NUP type and the non-locating bearing consists of a cylindrical roller bearing, NU type.

d) The locating bearings consist of a cylindrical roller bearing, NU type which takes over radial loads and of a four-point contact ball bearing (unloaded on the outside). The non-locating bearing consists of a cylindrical roller bearing, NU type.

e) The locating bearings consists of a cylindrical

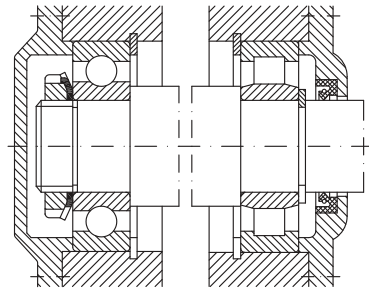

locating bearing a) non-locating bearing

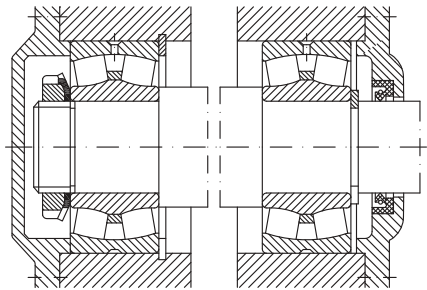

locating bearing b) non-locating bearing

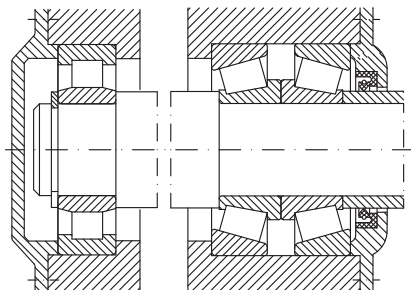

locating bearing c) non-locating bearing

Fig. 4.1

roller bearing, NU type which take over radial loads and of a four-point contact ball bearing (unloaded on the outside). The non-locating bearing consists of a cylindrical roller bearing, NU type.

f) The locating bearing consists of a needle roller

bearing, NA type which takes over radial loads and of a single row deep groove ball bearing (unloaded on the outside) which takes over axial loads in both directions. The non-locating bearing consists of a needle roller bearing, NA type.

g) The shaft bearings can also be X-type arrangement of two tapered roller bearings which can be considered mutual located bearing.

Recommendation for bearing fit selection

Three main criteria have to be considered when selecting the bearing fit:

- Firm location and uniform support of bearings;
- Simply mounting and dismounting;
- Axial displacement of non-locating bearing.

The most common location is assured by tight fit.

A high tightening is recommended for roller bearings and large-sized bearings in comparison to ball bearings of the same size.

In case of a tight fit, the inner ring is supported by the entire shaft contact surface, thus bearing is used at full load carrying capacity.

The tolerance classes given in table 4.1 and 4.3 are available for bearing fits which do not exceed $+120^\circ$ during operation.

As a general rule, selection of the tolerance class "H" is recommended for bearings of separable design and tolerance class "J" for bearings of non-separable design.

When selecting a fit, the load of rotating ring has to consider, namely:

- If the inner ring rotates and the load is stationary, the outer ring should be mounted with clearance fit.
- If the inner ring rotates and the load is stationary, the outer ring should be mounted with a tight fit.
- If the inner ring rotates and the direction of load is not determined, both rings should be mounted with a tight fit.

In table 4.1, there are given recommendations to select the tolerance class for shaft as function of: bearing type, loading and shaft diameter. In table 4.3, one can find recommendations to select the

tolerance class for housing,

Figure 4.2 shows schematically the tolerance classes for shaft and housing and their influence over fit type i.e. clearance, transition or tight fit for housing and transition fit or tight fit for shaft, respectively.

In tables 4.2 and 4.4, the deviations of the shaft diameter (4.2) and of the housing diameter (4.4) are given, considering the following:

- upper and lower limits
- theoretical minimum and maximum values of tightening (+) or clearance (0) in the fit.
- the minimum and maximum values of the probable tightening or clearance in the fit (99% of fits are between these limits).

The tolerances of bore diameter d_{mp} and outside diameter D_{mp} are valid for all metric sized bearings, except tapered roller bearings with $d < 30$ mm and $D < 150$ mm and thrust ball bearings with $D \leq 150$ mm, (see table 3.15 and 3.16 on page 34 and table 3.31 and 3.32 on page 39-40).

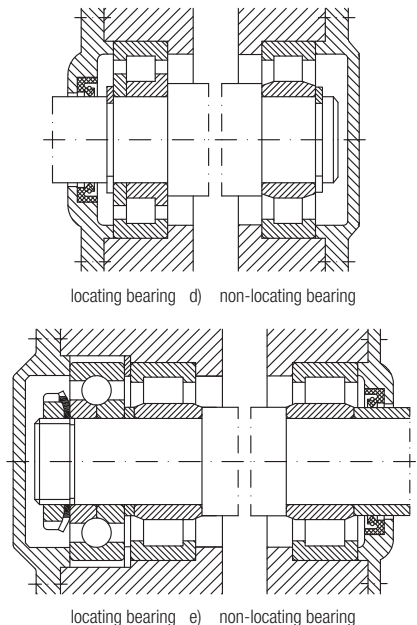

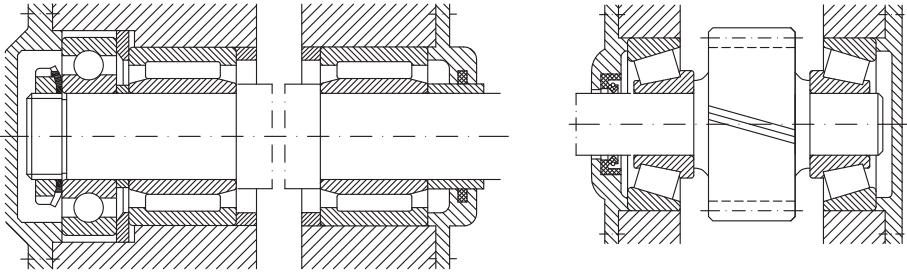

locating bearing f) non-locating bearing

g)

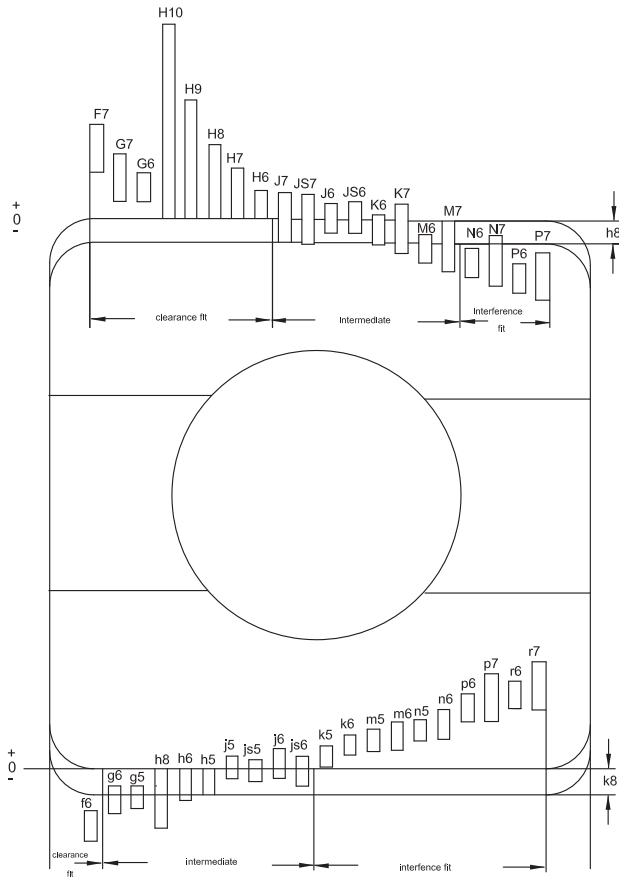
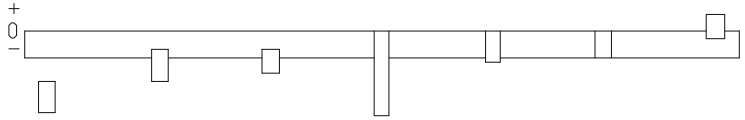

Fig. 4.2

Bearing application					
Tolerance classes for shafts					Table 4.1
Operating conditions	Examples	Shaft diameter [mm]			
		Ball bearings	Cylindrical needle and tapered roller bearings	Spherical roller bearings	Tolerance class symbol
Radial bearings with cylindrical bore					
Stationary load on the inner ring					
Easy axial displacement of inner ring on shaft desirable	Wheels on non-rotating shafts (free wheels)	All diameters			g6 (f6)
Axial displacement of inner ring on shaft not necessary	Tension pulleys, sheaves				h6
Rotating inner ring load					
Light and variable loads (P<0,06C)	Conveyers, lightly loaded mechanisms	18...100	≤40		j6
		>100...140	>40...100		k6
Normal and heavy loads (P>0,06C)	General mechanical engineering electric motors, turbines, pumps, gearboxes, woodworking machines	≤18	-	-	j5
		> 18...100	≤40	≤40	k5(k6)
		>100...140	>40...100	>40...65	m5(m6)
		>140...200	>100...140	>65...100	m6
		>200...280	>140...200	>100...140	n6
		-	>200...400	>140...280	p6
		-	-	>280...500	r6
Heavy loads and shock loads, arduous working conditions (P>0,12C)	Heavy duty railway vehicles axle bearings, traction motors, rolling mills	-	>50...140	>50...100	n6
		-	>140...200	>100...200	p6
		-	>200	>200	r6
High running accuracy, light loads (P<0,06C)	Machine tools	≤18	-	-	h5
		> 18...100	≤40	-	j5
		>100...200	>40...140	-	k5
		-	>140...200	-	m5
Axial loads					
	All kind of bearing application	≤250	≤250	≤250	j6
		>250	>250	>250	js6
Tapered bore bearings with withdrawal or adapter sleeve					
	Axle shaft for railway vehicles General mechanical engineering	All diameters			h9 h10
Thrust bearings					
Axial loads					
Thrust ball bearings		All sizes			h6
Cylindrical and needle roller thrust bearings		All sizes			h6 (h8)
Cylindrical, needle roller and cage thrust assembly		All sizes			h8
Combined loads spherical roller thrust bearings					
Stationary load on shaft washer		≤250			j6
		>250			js6
Rotating load on shaft washer or undetermined load direction		≤200			k6
		> 200...400			m6
		>400			n8



Bearing application
Shaft fits Table 4.2

Shaft nominal diameter		Bearing Bore diameter tolerance		Deviations of shaft diameter, resultant fits Tolerances													
d		Δd_{mp}		f6	g6		g5		h8		h6		h5		j5		
over	up to	low	high	a) Deviations (shaft diameter) b) Tightening/Theoretical clearance c) Tightening/Probable clearance													
mm		μm															
1	3	-8	0	a) -6	-12	-2	-8	-2	-6	0	-14	0	-6	0	-4	+2	-2
				b) +2	-12	+6	-8	+6	-6	+8	-14	-8	-6	+8	-4	+10	0
				c) 0	-10	+4	-6	+5	-5	+6	-12	+6	-4	+7	-3	+9	-1
3	6	-8	0	-10	-18	-4	-12	-4	-9	0	-18	0	-8	0	-5	+3	-2
				-2	-18	+4	-12	+4	-9	+8	-18	+8	-8	+8	-5	+11	-2
				-4	-16	+2	-10	+3	-8	+5	-15	+6	-6	+7	-4	+10	-1
6	10	-8	0	-13	-22	-5	-14	-5	-11	0	-22	0	-9	0	-6	+4	-2
				-5	-22	+3	-14	+3	-11	+8	-22	+8	-9	+8	-6	+12	-2
				-7	-20	+1	-12	+1	-9	+5	-19	+6	-7	+6	-4	+10	0
10	18	-8	0	-16	-27	-6	-17	-6	-14	0	-27	0	-11	0	-8	+5	-3
				-8	-27	+2	-17	+2	-14	+8	-27	+8	-11	+8	-8	+13	-3
				-10	-25	0	-15	0	-12	+5	-24	+6	-9	+6	-6	+11	-1
18	30	-10	0	-20	-33	-7	-20	-7	-16	0	-33	0	-13	0	-9	+5	-4
				-10	-33	+3	-20	+3	-16	+10	-33	+10	-13	+10	-9	+15	-4
				-13	-30	0	-17	+1	-14	+6	-29	+7	-10	+8	-7	+13	-2
30	50	-12	0	-25	-41	-9	-25	-9	-20	0	-39	0	-16	0	-11	+6	-5
				-13	-41	+3	-25	+3	-20	+12	-39	+12	-16	+12	-11	+18	-5
				-17	-37	-1	-21	0	-17	+7	-34	+8	-12	+9	-8	+15	-2
50	80	-15	0	-30	-49	-10	-29	-10	-23	0	-46	0	-19	0	-13	+6	-7
				-15	-49	+5	-29	+5	-23	+15	-46	+15	-19	+15	-13	+21	-7
				-19	-45	+1	-25	+1	-19	+9	-40	+11	-15	+11	-9	+17	-3
80	120	-20	0	-36	-58	-12	-34	-12	-27	0	-54	0	-22	0	-15	+6	-9
				-16	-58	+8	-34	+8	-27	+20	-54	+20	-22	+20	-15	+26	-9
				-22	-52	+2	-28	+3	-22	-12	-46	+14	-16	+15	-10	+21	-4
120	180	-25	0	-43	-68	-14	-39	-14	-32	0	-63	0	-25	0	-18	+7	-11
				-18	-68	+11	-39	+11	-32	+25	-63	+25	-25	+25	-18	+32	-11
				-25	-61	+4	-32	+5	-26	+15	-53	+18	-18	+19	-12	+26	-5
180	250	-30	0	-50	-79	-15	-44	-15	-35	0	-72	0	-29	0	-20	+7	-13
				-20	-79	+15	-44	+15	-35	+30	-72	+30	-29	+30	-20	+37	-13
				-28	-71	+7	-36	+9	-29	+18	-60	+22	-21	+24	-14	+31	-7
250	315	-35	0	-56	-88	-17	-49	-17	-40	0	-81	0	-32	0	-23	+7	-16
				-21	-88	+18	-49	+18	-40	+35	-81	+35	-32	+35	-23	+42	-16
				-30	-79	+9	-40	+10	-32	+22	-68	+26	-23	+27	-15	+34	-8
315	400	-40	0	-62	-98	-18	-54	-18	-43	0	-89	0	-36	0	-25	+7	-18
				-22	-98	+22	-54	+22	-43	+40	-89	+40	-36	+40	-25	+47	-18
				-33	-87	+11	-43	+14	-35	+25	-74	+29	-25	+32	-17	+39	-10

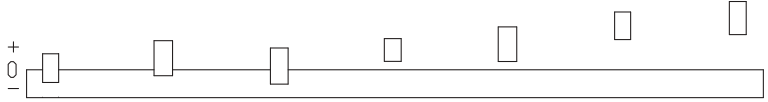

Bearing application																	
Shaft fits																	
Table 4.2 (continued)																	
Shaft nominal diameter		Bearing Bore diameter tolerance		Deviations of shaft diameter, resultant fits tolerances													
d		Δd_{mp}		js5	j6	js6	k5	k6	m5	m6							
over	up to	low	high	a) Deviations (shaft diameter) b) Tightening/Theoretical clearance c) Tightening/Probable clearance													
mm		μm															
1	3	-8	0	a) +2	-2	+4	-2	+3	-3	+4	0	+6	0	+6	+2	+8	+2
				b) +10	-2	+12	-2	+11	-3	+12	0	+14	0	+14	+2	+16	+2
				c) +9	-1	+10	0	+9	-1	+11	+1	+12	+2	+13	+3	+14	+4
3	6	-8	0	+2,5	-2,5	+6	-2	+4	-4	+6	+1	+9	+1	+9	+4	+12	+4
				+10,5	-2,5	+14	-2	+12	-4	+14	+1	+17	+1	+17	+4	+20	+4
				+9	-1	+12	0	+10	-2	+13	+2	+15	+3	+16	+5	+18	+6
6	10	-8	0	+3	-3	+7	-2	+4,5	-4,5	+7	+1	+10	+1	+12	+6	+15	+6
				+11	-3	+15	-2	+12,5	-4,5	+15	+1	+18	+1	+20	+6	+23	+6
				+9	-1	+13	0	+11	-3	+13	+3	+16	+3	+18	+8	+21	+8
10	18	-8	0	+4	-4	+8	-3	+5,5	-5,5	+9	+1	+12	+1	+15	+7	+18	+7
				+12	-4	+16	-3	+13,5	-5,5	+17	+1	+20	+1	+23	+7	+26	+7
				+10	-2	+14	-1	+11	-3	+15	+3	+18	+3	+21	+9	+24	+9
18	30	-10	0	+4,5	-4,5	+9	-4	+6,5	-6,5	+11	+2	+15	+2	+17	+8	+21	+8
				+14,5	-4,5	+19	-4	+16,5	-6,5	+21	+2	+25	+2	+27	+8	+31	+8
				+12	-2	+16	-1	+14	-4	+19	+4	+22	+5	+25	+10	+28	+11
30	50	-12	0	+5,5	-5,5	+11	-5	+8	-8	+13	+2	+18	+2	+20	+9	+25	+9
				+17,5	-5,5	+23	-5	+20	-8	+25	+2	+30	+2	+32	+9	+37	+9
				+15	-3	+19	-1	+16	-4	+22	+5	+26	+6	+29	+12	+33	+13
50	80	-15	0	+6,5	-6,5	+12	-7	+9,5	-9,5	+15	+2	+21	+2	+24	+11	+30	+11
				+21,5	-6,5	+27	-7	+24,5	-9,5	+30	+2	+36	+2	+39	+11	+45	+11
				+18	-3	+23	-3	+20	-5	+26	+6	+32	+6	+35	+15	+41	+15
80	120	-20	0	+7,5	-7,5	+13	-9	+11	-11	+18	+3	+25	+3	+28	+13	+35	+13
				+27,5	-7,5	+33	-9	+31	-11	+38	+3	+45	+3	+48	+13	+55	+13
				+23	-3	+27	-3	+25	-5	+33	+8	+39	+9	+43	+18	+49	+19
120	180	-25	0	+9	-9	+14	-11	+12,5	-12,5	+21	+3	+28	+3	+33	+15	+40	+15
				+34	-9	+39	-11	+37,5	-12,5	+46	+3	+53	+3	+58	+15	+65	+15
				+28	-3	+32	-4	+31	-6	+40	+9	+46	+10	+52	+21	+58	+22
180	250	-30	0	+10	-10	+16	-13	+14,5	-14,5	+24	+4	+33	+4	+37	+17	+46	+17
				+40	-10	+46	-13	+44,5	-14,5	+54	+4	+63	+4	+67	+17	+76	+17
				+34	-4	+38	-5	+36	-6	+48	+10	+55	+12	+61	+23	+68	+25
250	315	-35	0	+11,5	-11,5	+16	-16	+16	-16	+27	+4	+36	+4	+43	+20	+52	+20
				+46,5	-11,5	+51	-16	+51	-16	+62	+4	+71	+4	+78	+20	+87	+20
				+39	-4	+42	-7	+42	-7	+54	+12	+62	+13	+70	+28	+78	+29
315	400	-40	0	+12,5	-12,5	+18	-18	+18	-18	+29	+4	+40	+4	+46	+21	+57	+21
				+52,5	-12,5	+58	-18	+58	-18	+69	+4	+80	+4	+89	+21	+97	+21
				+44	-4	+47	-7	+47	-7	+61	+12	+69	+15	+78	+29	+86	+32

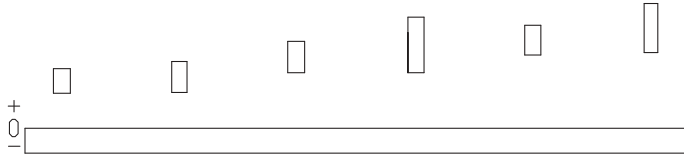

Table 4.2. (continued)

Bearing application															
Shaft fits															
Shaft nominal diameter		Bearing Bore diameter tolerance		Deviations of shaft diameter, resultant fits Tolerances											
d		Δd _{mp}		n5	n6	p6	p7	r6	r7						
over	up to	low	high	a) Deviations (shaft diameter) b) Tightening/Theoretical clearance c) Tightening/Probable clearance											
mm		μm													
1	3	-8	0	a) +8	+4	+10	+4	+12	+6	+16	+6	+16	+10	+20	+10
				b) +16	+4	+18	+4	+20	+6	+24	+6	+24	+10	+28	+10
				c) +15	+5	+16	+6	+18	+8	+22	+8	+22	+12	+26	+12
3	6	-8	0	+13	+8	+16	+8	+20	+12	+24	+12	+23	+15	+27	+15
				+21	+8	+24	+8	+28	+12	+32	+12	+31	+15	+35	+15
				+20	+9	+22	+10	+26	+14	+30	+14	+29	+17	+33	+17
6	10	-8	0	+16	+10	+19	+10	+24	+15	+30	+15	+28	+19	+34	+19
				+24	+10	+27	+10	+32	+15	+38	+15	+36	+19	+42	+19
				+22	+12	+25	+12	+30	+17	+35	+18	+34	+21	+39	+22
10	18	-8	0	+20	+12	+23	+12	+29	+18	+36	+18	+34	+23	+41	+23
				+28	+12	+31	+12	+37	+18	+44	+18	+42	+23	+49	+23
				+26	+14	+29	+14	+35	+20	+41	+21	+40	+25	+46	+26
18	30	-10	0	+24	+15	+28	+15	+35	+22	+43	+22	+41	+28	+49	+28
				+34	+15	+38	+15	+45	+22	+53	+22	+51	+28	+59	+28
				+32	+17	+35	+18	+42	+25	+50	+25	+48	+31	+56	+31
30	50	-12	0	+28	+17	+33	+17	+42	+26	+51	+26	+50	+34	+59	+34
				+40	+17	+45	+17	+54	+26	+63	+26	+62	+34	+71	+34
				+37	+20	+41	+21	+50	+30	+59	+30	+58	+38	+67	+38
50	65	-15	0	+33	+20	+39	+20	+51	+32	+62	+32	+60	+41	+71	+41
				+48	+20	+54	+20	+66	+32	+77	+32	+75	+41	+86	+41
				+44	+24	+50	+24	+62	+36	+72	+37	+71	+45	+81	+46
65	80	-15	0	+33	+20	+39	+20	+51	+32	+62	+32	+62	+43	+73	+43
				+48	+20	+54	+20	+66	+32	+77	+32	+77	+43	+88	+43
				+44	+24	+50	+24	+62	+36	+72	+37	+73	+47	+83	+48
80	100	-20	0	+38	+23	+45	+23	+59	+37	+72	+37	+73	+51	+86	+51
				+58	+23	+65	+23	+79	+37	+92	+37	+93	+51	+106	+51
				+53	+28	+59	+29	+73	+43	+85	+44	+87	+57	+99	+58
100	120	-20	0	+38	+23	+45	+23	+59	+37	+72	+37	+76	+54	+89	+54
				+58	+23	+65	+23	+79	+37	+92	+37	+96	+54	+109	+54
				+53	+28	+59	+29	+73	+43	+85	+44	+90	+60	+102	+61
120	140	-25	0	+45	+27	+52	+27	+68	+43	+83	+43	+88	+63	+103	+63
				+70	+27	+77	+27	+93	+43	+108	+43	+113	+63	+128	+63
				+64	+33	+70	+34	+86	+50	+100	+51	+106	+70	+120	+71
140	160	-25	0	+45	+27	+52	+27	+68	+43	+83	+43	+90	+65	+105	+65
				+70	+27	+77	+27	+93	+43	+108	+43	+115	+65	+130	+65
				+64	+33	+70	+34	+86	+50	+100	+51	+108	+72	+122	+73
160	180	-25	0	+45	+27	+52	+27	+68	+43	+83	+43	+93	+68	+108	+68
				+70	+27	+77	+27	+93	+43	+108	+43	+118	+68	+133	+68
				+64	+33	+70	+34	+86	+50	+100	+51	+111	+75	+125	+76

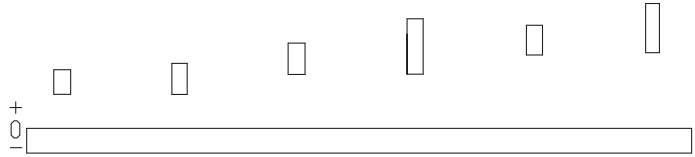

Table 4.2 (continued)

Bearing application															
Shaft fits															
Shaft nominal diameter		Bearing Bore diameter tolerance		Deviations of shaft diameter, resultant fits Tolerances											
d		Δd_{mp}		n5	n6		p6		p7		r6		r7		
over	up to	low	high	a) Deviations (shaft diameter) b) Tightening/Theoretical clearance c) Tightening/Probable clearance											
mm		μm													
180	200	-30	0	a)+51	+31	+60	+31	+79	+50	+96	+50	+106	+77	+123	+77
				b)+81	+31	+90	+31	+109	+50	+126	+50	+136	+77	+153	+77
				c)+75	+37	+82	+39	+101	+58	+116	+60	+128	+85	+143	+87
200	225	-30	0	+51	+31	+60	+31	+79	+50	+96	+50	+109	+80	+126	+80
				+81	+31	+90	+31	+109	+50	+126	+50	+139	+80	+156	+80
				+75	+37	+82	+39	+101	+58	+116	+60	+131	+88	+146	+90
225	250	-30	0	+51	+31	+60	+31	+79	+50	+96	+50	+113	+84	+130	+84
				+81	+31	+90	+31	+109	+50	+126	+50	+143	+84	+160	+84
				+75	+37	+82	+39	+101	+58	+116	+60	+135	+92	+150	+94
250	280	-35	0	+57	+34	+66	+34	+88	+56	+108	+56	+126	+94	+146	+94
				+92	+34	+101	+34	+123	+56	+143	+56	+161	+94	+181	+94
				+84	+42	+92	+43	+114	+65	+131	+68	+152	+103	+169	+106
280	315	-35	0	+57	+34	+66	+34	+88	+56	+108	+56	+130	+98	+150	+98
				+92	+34	+101	+34	+123	+56	+143	+56	+165	+98	+185	+98
				+84	+42	+92	+43	+114	+65	+131	+68	+156	+107	+173	+110
315	355	-40	0	+62	+37	+73	+37	+98	+62	+119	+62	+144	+108	+165	+108
				+102	+37	+113	+37	+138	+62	+159	+62	+184	+108	+205	+108
				+94	+45	+102	+48	+127	+73	+146	+75	+173	+119	+192	+121
355	400	-40	0	+62	+37	+73	+37	+98	+62	+119	+62	+150	+114	+171	+114
				+102	+37	+113	+37	+138	+62	+156	+62	+190	+114	+211	+114
				+94	+45	+102	+48	+127	+73	+146	+75	+179	+125	+198	+127

Bearing application Tolerance classes for housing bores Radial bearings			
Table 4.3			

Solid housing Operating conditions	Examples	Tolerance class symbol	Outer ring displacement
Rotating outer ring load			
Heavy loads on bearings in thin-walled housings, heavy shock loads ($P > 0,12 C$)	Roller bearing wheel hubs, connecting rod bearings	P7	Outer ring cannot be displaced
Normal and heavy loads ($P > 0,06 C$)	Ball bearing wheel hubs, connecting rod bearings, crane traveling wheels	N7	
Light and variable loads ($P \leq 0,06 C$)	Conveyor rollers, rope sheaves, belt tension pulleys	M7	
Direction of load indeterminate			
Heavy shock loads	Traction motors	M7	Outer ring cannot be displaced
Normal and heavy loads ($P > 0,06 C$) Outer ring displacement is not necessary	Electric motors, pumps, crankshaft main bearings	K7	

Split or solid housing Operating conditions	Examples	Tolerance class symbol	Outer ring displacement
Direction of load indeterminate			
Light and normal loads Desirable outer ring displacement ($P \leq 0,12 C$)	Medium-sized electric motors, pumps, crankshaft main bearings	J7	Outer ring cannot be displaced
Stationery outer ring load			
All kind of loads	General mechanical engineering, railway axleboxes	H7	Outer ring can be easily displaced
Light and normal loads with simple conditions ($P \leq 0,12 C$)		H8	
Heat conduction through shaft	Drying cylinders, large electrical machines with spherical roller bearings	G7	

Bearing application Tolerance classes for housing bores Radial bearings				
Table 4.3 (continued)				
Split housing Operating conditions	Examples	Tolerance class symbol	Outer ring displacement	
High accuracy rotation, quiet running				
High stiffness at variable loads	Main shafts for machine-tools with roller bearings	D \leq 125 D $>$ 125	M6 N6	The outer ring cannot be displaced.
Light loads, indeterminate load direction	Shaft operating surface for grinding machines with ball bearing, free bearing for high speed superchargers	K6		The outer ring cannot be displaced.
Desirable outer ring displacement	Shaft operating surface for grinding machines with ball bearing, free bearing for high speed superchargers	J6		The outer ring can be displaced.
Quiet running	Small-sized electrical machines	H6		The outer ring can be easily displaced

Tolerance classes for housing bores Thrust bearings		
Table 4.3 (continued)		
Thrust bearings Operating conditions	Tolerance class symbol	Outer ring displacement
Axial load		
Thrust ball bearings Cylindrical and needle roller thrust bearings	H8 H7 (H9)	For less accurate bearing arrangements, radial clearance in housing can be up to 0,001 D
Combined loads on spherical roller thrust bearings		
Local load on housing washer Peripheral load on housing washer	H7 (H9) M7	
Axial or combined load on spherical roller thrust bearings		
Bearing radial location is ensured by another bearing	-	Housing washer fitted with clearance up to 0,001 D

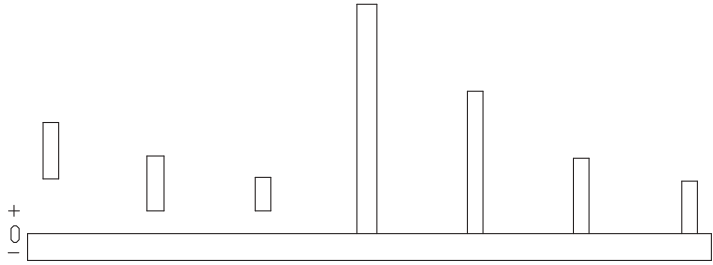

**Bearing application
Housing fits**

Table 4.4

Housing nominal diameter		Bearing Outside diameter tolerance		Deviations of housing bore diameter, resultant fits Tolerances													
D		Δd_{mp}		F7	G7	G6	H10	H9	H8	H7							
over	up to	low	high	a) Deviations (shaft diameter) b) Tightening/Theoretical clearance c) Tightening/Probable clearance													
mm		μm															
6	10	-8	0	a) +13	+28	+5	+20	+5	+14	0	+58	0	+36	0	+22	0	+15
				b) -13	-36	-5	-28	-5	-22	0	-66	0	-44	0	-30	0	-23
				c) -16	-33	-8	-25	-7	-20	-3	-63	-3	-41	-3	-27	-3	-20
10	18	-8	0	+16	+34	+6	+24	+6	+17	0	+70	0	+43	0	+27	0	+18
				-16	-42	-6	-32	-6	-25	0	-78	0	-51	0	-35	0	-26
				-19	-39	-9	-29	-8	-23	-3	-75	-3	-48	-3	-32	-3	-23
18	30	-9	0	+20	+41	+7	+28	+7	+20	0	+84	0	+52	0	+33	0	+21
				-20	-50	-7	-37	-7	-29	0	-93	0	-61	0	-42	0	-30
				-23	-47	-10	-34	-10	-26	-4	-89	-4	-57	-3	-39	-3	-27
30	50	-11	0	+25	+50	-9	+34	+9	+25	0	+100	0	+62	0	+39	0	+25
				-25	-61	-9	-45	-9	-36	0	-111	0	-73	0	-50	0	-36
				-29	-57	-13	-41	-12	-33	-5	-106	-5	-68	-4	-46	-4	-32
50	80	-13	0	+30	+60	+10	+40	+10	+29	0	+120	0	+74	0	+46	0	+30
				-30	-73	-10	-53	-10	-42	0	-133	0	-87	0	-59	0	-43
				-35	-68	-15	-48	-14	-38	-6	-127	-5	-82	-5	-54	-5	-38
80	120	-15	0	+36	+71	+12	+47	+12	+34	0	+140	0	+87	0	+54	0	+35
				-36	-86	-12	-62	-12	-49	0	-155	0	-102	0	-69	0	-50
				-41	-81	-17	-57	-17	-44	-7	-148	-6	-96	-6	-63	-5	-45
120	150	-18	0	+43	+83	+14	+54	+14	+39	0	+160	0	+100	0	+63	0	+40
				-43	-101	-14	-72	-14	-57	0	-178	0	-118	0	-81	0	-58
				-50	-94	-21	-65	-20	-51	-8	-170	-8	-110	-7	-74	-7	-51
150	180	-25	0	+43	+83	+14	+54	+14	+39	0	+160	0	+100	0	+63	0	+40
				-43	-108	-14	-79	-14	-64	0	-185	0	-125	0	+88	0	-65
				-51	-100	-22	-71	-21	-57	-11	-174	-10	-115	-10	-78	-8	-57
180	250	-30	0	+50	+96	+15	+61	+15	+44	0	+185	0	+115	0	+72	0	+46
				-50	-126	-15	-91	-15	-74	0	-215	0	-145	0	-102	0	-76
				-60	-116	-25	-81	-23	-66	-13	-202	-13	-132	-12	-90	-10	-66
250	315	-35	0	+56	+108	-17	+69	+17	+49	0	+210	0	+130	0	+81	0	+52
				-56	-143	-17	-104	-17	-84	0	-245	0	-165	0	-116	0	-87
				-68	-131	-29	-92	-26	-75	-16	-229	-15	-150	-13	-103	-12	-75
315	400	-40	0	+62	+119	+18	+75	+18	+54	0	+230	0	+140	0	+89	0	+57
				-62	-159	-18	-115	-18	-94	0	-270	0	-180	0	-129	0	-97
				-75	-146	-31	-102	-29	-83	-18	-252	-17	-163	-15	-114	-13	-84
400	500	-45	0	+68	+131	+20	+83	+20	+60	0	+250	0	+155	0	+97	0	+63
				-68	-176	-20	-128	-20	-105	0	-295	0	-200	0	-142	0	-108
				-83	-161	-35	-113	-32	-93	-20	-275	-19	-181	-17	-125	-15	-93

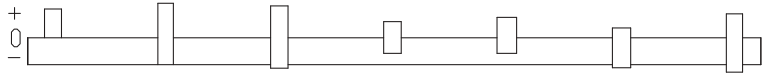

Bearing application Housing fits										Table 4.4 (continued)									
Housing nominal diameter		Bearing Outside diameter tolerance		Deviations of housing bore diameter, resultant fits Tolerances															
D		Δd_{mp}		H6		J7		JS7		J6		JS6		K6		K7			
over	up to	low	high	a) Deviations (shaft diameter) b) Tightening/Theoretical clearance c) Tightening/Probable clearance															
mm		μm																	
6	10	-8	0	a)0	+9	-7	+8	-7,5	+7,5	-4	+5	-4,5	+4,5	-7	+2	-10	+5		
				b)0	-17	+7	+16	+7,5	-15,5	+4	-13	+4,5	-12,5	+7	-10	+10	-13		
				c)2	-15	+4	-13	+5	-13	+2	-11	+3	-11	+5	-8	+7	-10		
10	18	-8	0	0	+11	-8	+10	-9	+9	-5	+6	-5,5	+5,5	-9	+2	-12	+6		
				0	-19	+8	-18	+9	-17	+5	-14	+5,5	-13,5	+9	-10	+12	-14		
				-2	-17	+5	-15	+6	-14	+3	-12	+3	-11	+7	-8	+9	-11		
18	30	-9	0	0	+13	-9	+12	-10,5	+10,5	-5	+8	-6,5	+6,5	-11	+2	-15	+6		
				0	-22	+9	-21	+10,5	-19,5	+5	-17	+6,5	-15,5	+11	-11	+15	-15		
				-3	-19	+6	-18	+7	-16	+2	-14	+4	-13	+8	-8	+12	-12		
30	50	-11	0	0	+16	-11	+14	-12,5	+12,5	-6	+10	-8	+8	-13	+3	-18	+7		
				0	-27	+11	-25	-12,5	-23,5	+6	-21	+8	-19	+13	-14	+18	-18		
				-3	-24	+7	-21	+9	-20	+3	-18	+5	-16	+10	-11	+14	-14		
50	80	-13	0	0	+19	-12	+18	-15	+15	-6	+13	-9,5	+9,5	-15	+4	-21	+9		
				0	-32	+12	-31	+15	-28	+6	-26	+9,5	-22,5	+15	-17	+21	-22		
				-4	-28	+7	-26	+10	-23	+2	-22	+6	-19	+11	-13	+16	-17		
80	120	-15	0	0	+22	-13	+22	-17,5	+17,5	-6	+16	-11	+11	-18	+4	-25	+10		
				0	-37	+13	-37	+17,5	-32,5	+6	-31	+11	-26	+18	-19	+25	-25		
				-5	-32	+8	-32	+12	-27	+1	-26	+6	-21	+13	-14	+20	-20		
120	150	-18	0	0	+25	-14	+26	-20	+20	-7	+18	-12,5	+12,5	-21	+4	-28	+12		
				0	-43	+14	-44	+20	-38	+7	-36	+12,5	-30,5	+21	-22	+28	-30		
				-6	-37	+7	-37	+13	-31	+1	-30	+7	-25	+15	-16	+21	-23		
150	180	-25	0	0	+25	-14	+26	-20	+20	-7	+18	-12,5	+12,5	-21	+4	-28	+12		
				0	-50	+14	-51	+20	-45	+7	-43	+2,5	-37,5	+21	-29	+28	-37		
				-7	-43	+6	-43	+12	-37	0	-36	+6	-31	+14	-22	+20	-29		
180	250	-30	0	0	+29	-16	+30	-23	+23	-7	+22	-14,5	+14,5	-24	+5	-33	+13		
				0	-59	+16	-60	+23	-53	+7	-52	+14,5	-44,5	+24	-35	+33	-43		
				-8	-51	+6	-50	+13	-43	-1	-44	+6	-36	+16	-27	+23	-33		
250	315	-35	0	0	+32	-16	+36	-26	+26	-7	+25	-16	+16	-27	+5	-36	+16		
				0	-67	+16	-71	+26	-61	+7	-60	+16	+51	+27	-40	+36	-51		
				-9	-58	+4	-59	+14	-49	-2	-51	+7	-42	+18	-31	+24	-39		
315	400	-40	0	0	+36	-18	+39	-28,5	+28,5	-7	+29	-18	+18	-29	+7	-40	+17		
				0	-76	+18	-79	+28,5	-68,5	+7	-69	+18	-58	+29	-47	+40	-57		
				-11	-65	+5	-66	+15	-55	-4	-58	+7	-47	+18	-36	+27	-44		
400	500	-45	0	0	+40	-20	+43	-31,5	+31,5	-7	+33	-20	+20	-32	+8	-45	+18		
				0	-85	+20	-88	+31,5	-76,5	+7	-78	+20	-65	+32	-53	+45	-63		
				-12	-73	+5	-73	+17	-62	-5	-66	+8	-53	+20	-41	+30	-48		



**Bearing application
Housing fits**

Table 4.4 (continued)

Housing nominal diameter		Bearing Outside diameter tolerance		Deviations of housing bore diameter, resultant fits Tolerances											
D		Δd_{mp}		M6	M7	N6	N7	P6	P7						
over	up to	low	high	a) Deviations (shaft diameter) b) Tightening/Theoretical clearance c) Tightening/Probable clearance											
mm		μm													
6	10	-8	0	a)-12	-3	-15	0	-16	-7	-19	-4	-21	-12	-24	-9
				b)+12	-5	+15	-8	+16	-1	+19	-4	+21	+4	+24	+1
				c)+10	-3	+12	-5	+14	+1	+16	-1	+19	+6	+21	+4
10	18	-8	0	-15	-4	-18	0	-20	-9	-23	-5	-26	-15	-29	-11
				+15	-4	+18	-8	+20	+1	+23	-3	+26	+7	+29	+3
				+13	-2	+15	-5	+18	+3	+20	0	+24	+9	+26	+6
18	30	-9	0	-17	-4	-21	0	-24	-11	-28	-7	-31	-18	-35	-14
				+17	-5	+21	-9	+24	+2	+28	-2	+31	+9	+35	+5
				+14	-2	-18	-6	+21	+5	+25	+1	+28	+12	+32	+8
30	50	-11	0	-20	-4	-25	0	-28	-12	-33	-8	-37	-21	-42	-17
				+20	-7	+25	-11	+28	+1	+33	-3	+37	+10	+42	+6
				+17	-4	+21	-7	+25	+4	+29	+1	+34	+13	+38	+10
50	80	-13	0	-24	-5	-30	0	-33	-14	-39	-9	-45	-26	-51	-21
				+24	-8	+30	-13	+33	+1	+39	-4	+45	+13	+51	+8
				+20	-4	+25	-8	+29	+5	+34	+1	+41	+17	+46	+13
80	120	-15	0	-28	-6	-35	0	-38	-16	-45	-10	-52	-30	-59	-24
				+28	-9	+35	-15	+38	+1	+45	-5	+52	+15	+59	+9
				+23	-4	+30	-10	+33	+6	+40	0	+47	+20	+54	+14
120	150	-18	0	-33	-8	-40	0	-45	-20	-52	-12	-61	-36	-68	-28
				+33	-10	+40	-18	+45	+2	+52	-6	+61	+18	+68	+10
				+27	-4	+33	-11	+39	+8	+45	+1	+55	+24	+61	+17
150	180	-25	0	-33	-8	-40	0	-45	-20	-52	-12	-61	-36	-68	-28
				+33	-17	+40	-25	+45	-5	+52	-13	+61	+11	+68	+3
				+26	-10	+32	-17	+38	+2	+44	-5	+54	+18	+60	+11
180	250	-30	0	-37	-8	-46	0	-51	-22	-60	-14	-70	-41	-79	-33
				+37	-22	+46	-30	+51	-8	+60	-16	+70	+11	+79	+3
				+29	-14	+36	-20	+43	0	+50	-6	+62	+19	+69	+13
250	315	-35	0	-41	-9	-52	0	-57	-25	-66	-14	-79	-47	-88	-36
				+41	-26	+52	-35	+57	-10	+66	-21	+79	+12	+88	+1
				+32	-17	+40	-23	+48	-1	+54	-9	+70	+21	+76	+13
315	400	-40	0	-46	-10	-57	0	-62	-26	-73	-16	-87	-51	-98	-41
				+46	-30	+57	-40	+62	-14	+73	-24	+87	+11	+98	+1
				+35	-19	+44	-27	+51	-3	+60	-11	+76	+22	+85	+14
400	500	-45	0	-50	-10	-63	0	-67	-27	-80	-17	-95	-55	-108	-45
				+50	-35	+63	-45	+67	-18	+80	-28	+95	+10	+108	0
				+38	-23	+48	-30	+55	-6	+65	-13	+83	+22	+93	+15

Deviations of form and position

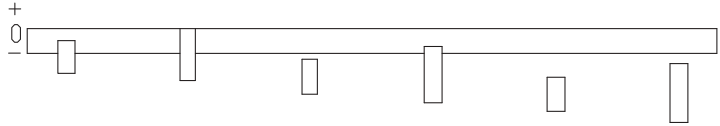
Permissible deviations of form and position for shaft and housing where bearings will be mounted are given in fig. 4.3 and table 4.5

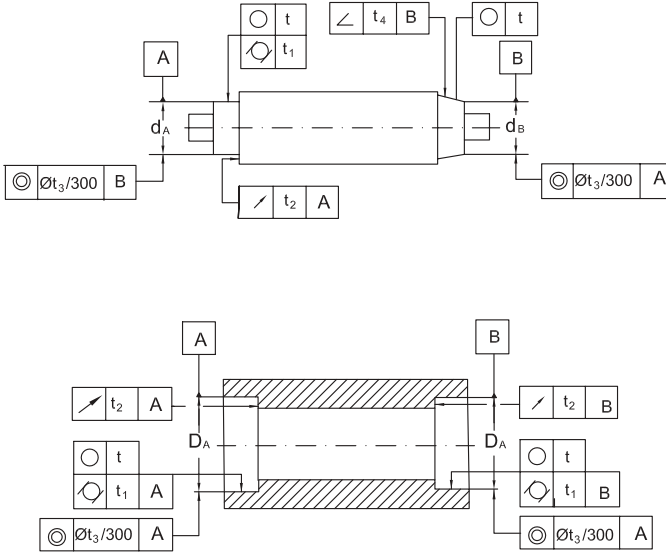

Fig. 4.3

Table 4.5

Tolerance name	Fit	Symbol of deviation	Permissible deviations depending on the tolerance class					
			P0 P6X	P6	P5	P4 (SP)	P2 (UP)	
Tolerance of dimension	shaft	-	-	IT6(IT5)	IT5	IT4	IT4	IT3
	housing		-	IT7(IT6)	IT6	IT5	IT4	IT4
Tolerance of roundness and cylindricity	shaft		t, t_1	IT4/2 (IT3/2)	IT3/2 (IT2/2)	IT2/2	IT1/2	IT0/2
	housing		t, t_1	IT5/2 (IT4/2)	IT4/2 (IT2/2)	IT3/2	IT2/2	IT1/2
Tolerance of face runout	shaft		t_2	IT4(IT3)	IT3(IT2)	IT2	IT1	IT0
	housing		t_2	IT5(IT4)	IT4(IT3)	IT3	IT2	IT1
Tolerance of concentricity	shaft		t_3	IT5	IT4	IT4	IT3	IT3
	housing		t_3	IT6	IT5	IT5	IT4	IT3
Tolerance of angularity	shaft		t_4	IT7/2	IT6/2	IT4/2	IT3/2	IT2/2

In case of bearings on which adapter or withdrawal sleeves are to be mounted, the shaft tolerances for deviations of form and position should be to IT5/2 tolerance class for shafts with diameter tolerance h9 and IT7/2 for shaft tolerance h10.

Surface roughness of bearing seating is given in table 4.6.

Shaft and housing mounting surfaces roughness								Table 4.6
Bearing tolerance class	Shaft			Housing				
	Diameter d, mm			Diameter D, mm				
	≤ 80	>80...500	> 500	≤ 80	> 80... 500	> 500		
Roughness Ra, [µm]								
P0, P6X and P6	0,8 (N6)	1,6 (N7)	3,2 (N8)	0,8 (N6)	1,6 (N7)	3,2 (N8)		
P5, SP and P4	0,4 (N5)	0,8 (N6)	1,6 (N7)	0,8 (N6)	1,6 (N7)	1,6 (N7)		
P2 and UP	0,2 (N4)	0,4 (N5)	0,8 (N6)	0,4 (N5)	0,8 (N6)	0,8 (N6)		

If bearings are mounted with adapter or withdrawal sleeves, shaft surface roughness should be of max. Ra = 1,6 µm

The values of fundamental tolerances – ISO (tolerance classes IT0...IT12) are given in table 4.7.

Tolerance ISO (IT)														Table 4.7
Nominal dimension														
over	1	3	6	10	18	30	50	80	120	180	250	315	400	500
up to	3	6	10	18	30	50	80	120	180	250	315	400	500	630
mm	Tolerances in micrometers (0,001 mm)													
IT0	0,5	0,6	0,6	0,8	1	1	1,2	1,5	2	3	4	5	6	
IT1	0,8	1	1	1,2	1,5	1,5	2	2,5	3,5	4,5	6	7	8	
IT2	1,2	1,5	1,5	2	2,5	2,5	3	4	5	7	8	9	10	
IT3	2	2,5	2,5	3	4	4	5	6	8	10	12	13	15	
IT4	3	4	4	5	6	7	8	10	12	14	16	18	20	
IT5	4	5	6	8	9	11	13	15	18	20	23	25	27	29
IT6	6	8	9	11	13	16	19	22	25	29	32	36	40	44
IT7	10	12	15	18	21	25	30	35	40	46	52	57	63	70
IT8	14	18	22	27	33	39	46	54	63	72	81	89	97	110
IT9	25	30	36	43	52	62	74	87	100	115	130	140	155	175
IT10	40	48	58	70	84	100	120	140	160	185	210	230	250	280
IT11	60	75	90	110	130	160	190	220	250	290	320	360	400	440
IT12	100	120	150	180	210	250	300	350	400	460	520	570	630	700

Bearing axial location

Axial location of the bearing is necessary for a proper guiding of bearing in an assembly under operation.

A tight fit is inadequate for the axial location of bearing. In case of locating bearings, axial location for both rings is generally needed. Some important solutions of bearing axial location, on shaft or into the housing are shown in Fig. 4.4.

In case of bearings with light axial loads, bearings can be located using a lock nut and a lock washer (a), an end plate fastened by a screw at the shaft end (b) and, for bearings carrying light axial loads, by lock rings mounted in shaft and housing grooves (c).

Bearing with NR design, with groove and snap ring on the outer ring, can be easily located by the lock ring (d). Tapered roller bearings can be located by supporting the inner ring on the shaft shoulder and the outer ring with a threaded ring and a safety plate fastened by a screw (e).

Tapered bore bearings can be mounted and axially located by adapter or withdrawal sleeves (f,g).

The axial load carrying capacity of the bearings mounted with adapter or withdrawal sleeves is governed by the friction between shaft and sleeve (g).

To locate radial bearings, where axial adjustment of the shaft is required, setting washers (i) or spacer rings (i) are used between the outer rings, the width of the spacer ring being experimentally determined, during mounting.

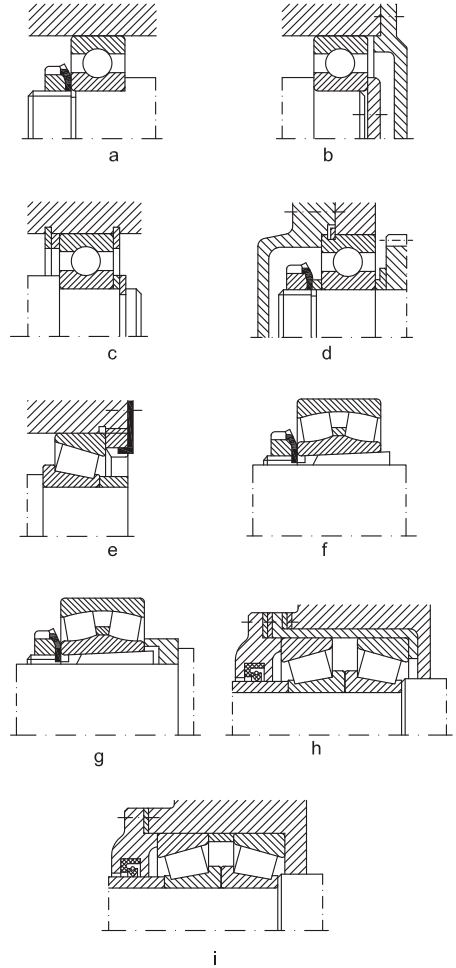

Fig. 4.4

Bearing sealing

Seals are used in most of bearing arrangements and they must ensure the conditions of a proper operation.

For such a purpose, they have to prevent solid contaminants (dust, hard particles, water, aggressive substances etc) from penetrating into the bearing and at the same time to retain the lubricant in the bearing.

Seals for rolling bearings can be classified

considering some important criteria such as: design, operations, type of lubricant etc.

Considering their design and operation, seals can be: stationary seals between the stationary bearing elements (housing and cover), rotary seals, between the rotating bearing elements and they also can be rubbing seals or non-rubbing seals, which are used in special applications (surrounding conditions and loading stress).

Rotary non-rubbing seals are often used due to their simple design. They are particularly used at high speeds or temperature, both for grease and oil, and have practically no friction and do not wear.

In case of bearing grease lubrication, bearing operating temperature must be lower with 20°C than the dropping point of the grease (melting temperature).

The main constructive types of rotary non-rubbing seals have narrow gaps, labyrinths and their combinations are shown in fig 4.5 a-c.

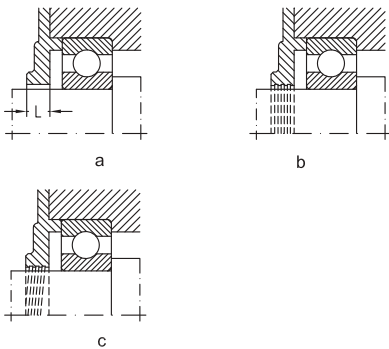
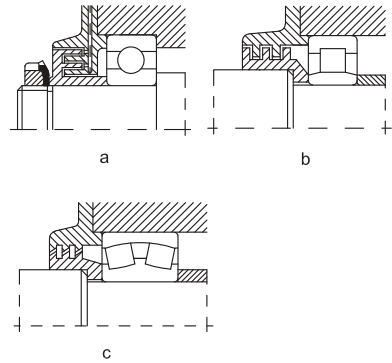

Fig. 4.5

Gap seals represent the simplest constructive solution for a rotary non-rubbing seal which have to retain grease in the bearing housing. The efficacy of sealing depends on the gap length (L) and the clearance between shaft and housing. It can be improved by providing one or more circular grooves on the shaft or in the housing, which are to be filled with grease (b). In case of oil lubrication, the grooves on the shaft must be helical (c) and their direction must be the same with the direction on the shaft rotary movement.

Experiments proved that most favorable clearance is obtained between the limits of the fit A11/h10, geometrical deviations should be IT6 and gap surface roughness $Ra=12,6 \mu\text{m}$.

Labyrinth seals are used at high peripheral speeds, in impure surroundings.

They are shown in fig. 4.6 a-d.

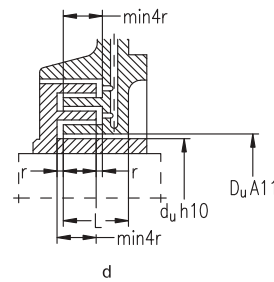

Fig. 4.6

The labyrinths are spaces where periodically water-in-soluble grease (e.g. Lithium or Calcium base grease) is to be supplied.

The tongues of the labyrinth seals can be radially (a), axially (b) arranged or they can have inclined passages.

Details of an axial labyrinth design are given in fig. 4.6 d and values of axial clearance and length L are given in table 4.8.

In case of rotary rubbing seals there is a direct contact between elastic seal element and the rotating element. They are shown in fig. 4.8.

When selecting the proper rotary rubbing seal, the following factors have to be considered: material and its elasticity (felt, rubber, plastics, leather, graphite, asbestos etc.); resistance at various temperatures, maximum peripheral speeds on sealing surface; sealing direction etc.

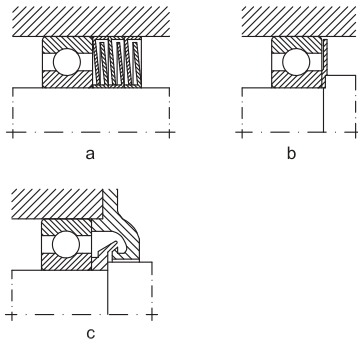

Fig. 4.7

These systems have sealing properties higher than those corresponding to non-rubbing seals. In case of grease lubrication at peripheral speeds higher than 4m/s and temperatures over +100°C, felt ring seals (a) are frequently used because of their simple design and cheapness.

Before mounting, felt rings are impregnated during one hour with a mixture of mineral oil (66%) and paraffin (34%), at a temperature of +70...+80°C so that sealing properties are improved as the friction is reduced.

At higher temperatures and peripheral speeds over 12 m/s, surface roughness is $R_a=1,6 \mu\text{m}$ and the space between the ends of the seal should be filled with grease. Two felt rings can be used for sealing.

Rubbing seals with a spring incorporated are preferably to be used in case of oil lubricated bearings which are operated under peripheral speeds of 5-10 m/s, temperatures between -40°C and +20°C. Their efficacy depends on the material and operating surroundings.

In most cases, rubbing seals with a spring incorporated are made of synthetic rubber and have a metallic hardening fixture.

Inclined sealing surfaces are recommended to be ground $R_a=0,8 \mu\text{m}$ and hardened at 45 HRC, when operating at peripheral speeds over 8 m/s. Lubricant outflow can be stopped by mounting the rubbing seal with incorporated spring with edge inwards (c)

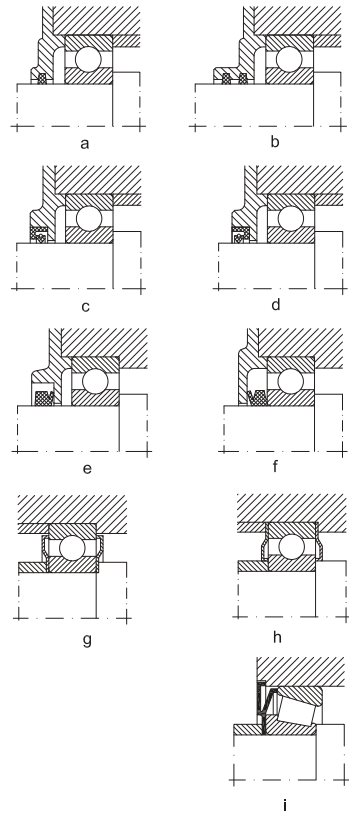

Fig. 4.8

or outwards (d) if sealing has to prevent dust or other impurities from penetrating into the bearing.

Double sealing with these rubbing seals can also be used.

V-ring seal is used to prevent dust or contaminants from penetrating into the bearing with best results both in case of grease or oil lubrication. The elastic rubber lip of the V-ring seal is notched on the plane sealing surface, drawing the fluids in centrifugal motion. V-ring seals are used at temperatures of -40°C...+100°C roughness of sealing surface being $R_a=1,5 - 3 \mu\text{m}$. Generally, at peripheral speeds up to 15 m/s, the V-ring seal operates as a rubbing seal (seal lip reaches sealing surface), and at peripheral speeds over 15 m/s the seal lip will lift from the

sealing surface, operating as a centrifugal sealing.

V-ring seals can also be used in case of angular misalignment of the shaft ($2^{\circ}\text{C} \dots 3^{\circ}\text{C}$) as they are made of high quality, elastic rubber, easy to be mounted.

The efficacy of sealing depends on the fact that the body ring acts as a flinger for dirt and fluids. Therefore, with grease lubrication the seal is generally arranged outside the housing and with oil lubrication it is placed inside the housing.

Pressed sheet washers provide simple, inexpensive and space-saving sealing especially for grease lubricated deep groove ball bearings. The washers are clamped against either the outer ring or the inner ring and exert a resilient pressure axially against the rubbing ring. In case of usual applications, the types of seals mentioned above or their combinations shown in fig. 4.9 are used, some of them becoming standard seals for rolling bearings (e.g. labyrinths, felt rings, V-rings etc). Thus, better sealing can be obtained if felt ring (a) or V-ring (b) rubbing seals are combined with radial or axial labyrinth non-rubbing seals.

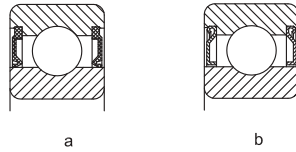

Fig. 4.10

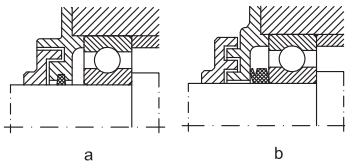

Fig. 4.9

Special seals are used in case of unusual surroundings and loading conditions (e.g. rolling mills, helm of ocean-vessels, main shaft of grinding machines etc).

Sealed bearings of the type 2RS (2RSR) (a) or shielded bearings of the type 2Z (2ZR) (b) shown in fig. 4.10 a.b. provide simple and inexpensive sealing, with upper operating results. These rolling bearings are delivered ready greased, provision for relubrication and maintenance are not needed. They are used in case of bearings with small free space where other seals cannot be used.

Bearing lubrication

Safe operating and long rating life of bearings depend on the lubricant type and quality and on the lubrication method. Bearing lubrication is used for certain purposes, such as:

- to reduce friction between rolling elements and raceway, rolling elements and cage
- to reduce friction between rolling elements and raceway, rolling elements and cage, cage and guiding ribs of rings during operation;
- to ensure anticorrosive protection of bearings;
- to reduce noise in bearing within certain limits;
- to distribute heat uniformly in contact areas and to remove it outside through lubricant circulation.

Lubricants for bearings lubrication should satisfy the following conditions:

- they should have physical and chemical stability;
- foreign mechanical substances (abrasive, metallic substances etc.) are not admitted in lubricant;
- they should have a minimal coefficient of friction;
- to be non-corrosive;
- good unctuosity (lubricating capacity).

There are two categories of lubricants used for bearing lubrication:

- fluid lubricants (oils);
- plastic lubricants (greases).

Table 5.1 shows comparison between fluid and plastic lubricants.

Although fluid lubricants have better characteristics than plastic lubricants, they cannot be used in all cases because of sealing difficulties.

Characteristics	Lubricant	
	Fluid	Plastic
speed	any value	low and medium
friction	low (reduced)	high
unctuosity	excellent	good
service life	long	short
cooling effect	high	low
replacement	easy	difficult

Selection of lubricants

When selecting lubricants, much care is needed and all operating conditions and lubricant properties

should be considered.

No lubrication system can be considered universal. The most important criteria when selecting a lubricant have to be as follows:

- size of bearing
- speed
- load
- bearing operating temperature

These characteristic act upon lubricant viscosity as follows:

- the higher the bearing size, value of load and temperature, the higher the viscosity
- bearing speed acts by product $D_m * n$, as show in table 5.2.

$D_m * n$ over	up to	Lubricant type
-	150x10 ³	Mineral oil and grease with medium or high viscosity
150x10 ³	300x10 ³	Mineral oil with medium viscosity and grease
300x10 ³	500x10 ³	Mineral oil with low viscosity and grease
500x10 ³	1200x10 ³	Mineral oil with low viscosity and lubricating equipment

Grease lubrication

Grease can be used to lubricate rolling bearings only when product $D_m * n \leq 500x10^3$ and it offers the following advantages:

- bearing speed acts by product $D_m n$, as show in table 5.2.
- it is more easily retained in the bearing;
- it assures anti-corrosive protection to bearing as it is water-resistant;
- low expenses for sealing.

The grease quantity to be supplied shouldn't be excessive, otherwise rotation is bracket, friction increases and also operating temperature without extending the bearing rating life.

The quantity of grease that is to be inserted in bearing seating should be as follows, considering the free space inside the housing:

- 1/2... 3/4 of the free space in the housing, in case of normal speeds;
- 1/3 of the free space in the housing, in case of high speeds and speed limit;
- whole housing freespace should be free, in case of low speeds and product $D_m * n < 10 \times 10^3$.

The quantity of grease can be calculated as a function of bearing bore diameter using the equation:

$$G = K d^{2.5}, g,$$

where:

- K= 1/900 - for ball bearings
- K= 1/350 - for roller bearings
- d = bore diameter, mm

Relubrication intervals in most cases can be experimentally determined and depend on:

- bearing type
- bearing size
- operating temperature
- grease properties

Grease service life and rubricating interval can be calculated from:

$$T_{ur} = k_0 \left(\frac{14 \cdot 10^6}{n\sqrt{d}} - 4d \right) f_1 f_2,$$

where:

- T_{ur} = service life or rubricating interval, in operating hours
- k_0 = coefficient depending on the bearing type, table 5.3
- n = speed, r/min
- d = bore diameter, mm
- f_1 = temperature factor, table 5.4
- f_2 = factor depending on the operating conditions, table 5.5

Low values are valid for deep groove ball bearings with shields, 2Z type, or with seals, 2RS type, series 60, 62 and 63.

Bearing relubrication interval can be also determined using the chart - fig. 5.1, as a function of bearing type, bore diameter and speed.

Example:

A bearing 6208-2RSR is operated under reduced load (it is not considered for calculation), at a speed $n = 1500$ r/min, at a temperature of +60 deg C, light operating conditions. What is the grease service life and relubrication interval?

Grease service life will be:

$$T_u = k_0 \cdot \left(\frac{14 \times 10^6}{n\sqrt{d}} \cdot 4d \right) f_1 f_2 = 32 \ 893 \text{ hours.}$$

$$k_0 = 25, \text{ from table 5.3}$$

$$d = 40 \text{ mm}$$

$$f_1 = 1, \text{ from table 5.4}$$

$$f_2 = 1, \text{ from table 5.5}$$

Relubrication interval:

$$T_r = k_0 \cdot \left(\frac{14 \times 10^6}{n\sqrt{d}} \cdot 4d \right) f_1 f_2 = 13 \ 157 \text{ hours.}$$

$$k_0 = 10, \text{ from table 5.3}$$

$$f_1, f_2 = 1, \text{ from tables 5.4, 5.5.}$$

The grease quantity to be supplied can be determined using the equation:

$$G = K D B, g,$$

Values for coefficient k_0			Table 5.3
Bearing type	Value of k_0		
	Relubrication interval	Grease service life	
Angular contact ball bearings Tapered roller bearings Thrust ball bearings	1	2	
Cylindrical roller bearings	5	15	
Deep groove ball bearings	10	20...40	

Values for factor f_1				Table 5.4
Temperature	70°C	85°C	100°C	
Factor f_1	1	0,5	0,25	

Values for factor f_2				
Table 5.5				
Operating conditions	Light	Moderate	Heavy	Very heavy
Factor f_2	1	0,7...0,9	0,4...0,7	0,1...0,4

Values for coefficient K	
Table 5.6	
Relubrication interval	K
weekly	0,0015...0,0020
monthly	0,0020...0,0030
yearly	0,0030...0,0045
after 2...3 years	0,0045...0,0055

From the diagram fig. 5.1, the value of the relubrication interval will be of 13500 operating hours.

where:

G = grease quantity, g

K = coefficient depending on the relubrication interval, table 5.6

D = bearing outside diameter, mm

B = total bearing width for radial bearings, mm and total bearing height for thrust bearings, mm

The chart in fig. 5.1 applies to operating temperatures which do not exceed +70°C. For operating temperatures over +70°C, see table 5.4. Grease service life can be defined as the period of time when it preserves physical and mechanical characteristics in time and oxidizing due to temperature and vaporization of base oil doesn't occur.

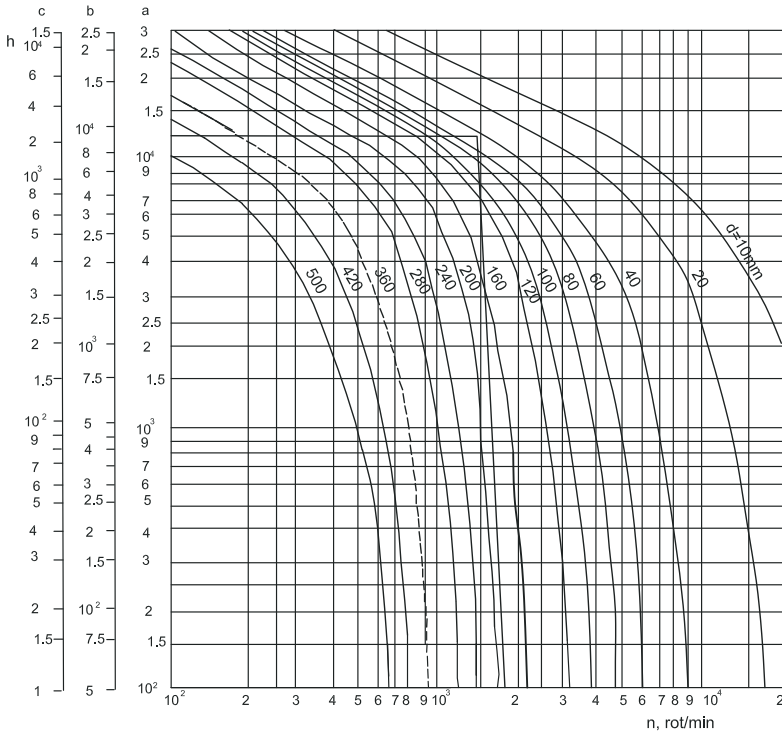

Fig. 5.1

Scale a: deep groove ball bearings

Scale b: cylindrical roller bearings

Scale c: spherical roller bearings, thrust ball bearings, cylindrical roller bearings without cage.

A more accurate calculation of grease service life, considering grease quality and bearing operating conditions (load, size, speed, temperature etc.) can be done using the equation:

$$L = 10^{a-(m_1+m_2+m_3)}$$

where:

L = service life, operating hours

a = exponent depending on the grease quality (a=5,8... 6,1)

m₁... m₃ = exponents which take into account the following factors:

$$m_1 = 4,4 \times 10^{-8} D_m * n,$$

$$m_2 = 2,5 (P/C - 0,05),$$

$$m_3 = (0,021 - 1,80 \times 10^{-6} D_m * n) t,$$

D_m = bearing mean diameter, mm

n = bearing speeds, r/min,

P = equivalent radial load, kN,

C = basic dynamic load, kN,

t = bearing operating temperature, °C

When calculating the values of t, D_m * n and P/C, the following have to be considered:

- when bearing operating temperature is lower than +50°C, then t = +50°C

- when speed factor D_m * n < 125000, then D_m * n = 125000

- when ratio P/C < 0,05, then P/C = 0,05

Grease service life, as a function of operating temperature can be approximately determined using the diagram fig. 5.2.

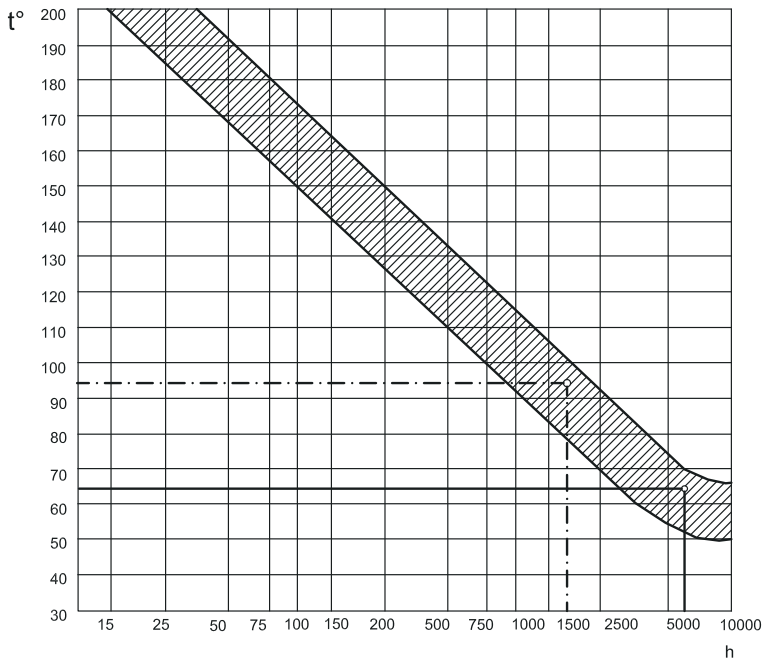

Fig. 5.2

Example 1

A bearing 6210 operates under a load $Pr = 5 \text{ kN}$, speed $n = 3000 \text{ r/min}$ at an operating temperature $t = 50^\circ\text{C}$. What is the service life of the grease used for bearing lubrication?

$Cr = 35,1 \text{ kN}$, tables on page 100. bearing 6210
 $L = 10^{a \cdot (m_1 + m_2 + m_3)} = 10^{6,1 \cdot 2,273} = 6214 \text{ hours}$

$a = 6,1$, for Mobil grease,

$D_m * n = 65 \times 3000 = 195 \times 10^3$

$Pr/Cr = 5/35,1 = 0,143$

$m_1 = 4,4 \times 10^{-6} D_m * n = 0,858$

$m_2 = 2,5 (Pr/Cr - 0,05) = 0,23$

$m_3 = (0,021 - 1,80 \times 10^{-8} D_m * n) 65 = 1,119$

Example 2

For the same bearing and operating conditions as in Example 1, it is required to find the service life of the same grease at a temperature of $t = 95^\circ\text{C}$.

$m_3 = 1,66$

$m_1 + m_2 + m_3 = 2,794$

$L = 10^{6,1 \cdot 2,794} = 10^{3,306} = 1774 \text{ operating hours}$

From the diagram fig. 5.2, we can find approximately the same value, respectively 6000 operating hours at $+65^\circ\text{C}$ and 170° operating hours at $+95^\circ\text{C}$.

Table 5.7 shows technical characteristics of usual grease, which are recommended for lubrication of sealed and shielded bearings, 2RS and 2Z types and also for rolling bearings in various assembled and machines.

Technical characteristics for usual greases for bearing lubrication					
Application	Thickener	Base Oil Viscosity @40°C	NLGI	Operating temperature range	Grease
General purpose industrial use, normal operation condition	Lithium	150	2	-30...+120	Mobilux EP2
	Lithium	100	3	-20...+130	Shell Gadus S2 V100 3
High temperatures and speeds. Long life. Low-noise performance (electric motors).	Polyurea	113	2	-20...+160	Mobil Polyrex™ EM
	Polyurea , EP	220	2	-20...+160	Shell Gadus S3 T220 2
High load, low-medium speed (cement, steel, crushers)	Lithium, EP	540	-	-20...+140	Klüberlub BE 41- 542
	Litium complex, EP	460	2	-20...+140	Mobilgrease XHP 462
	Litium complex, EP	460	2	-20...+150	Shell Gadus S3 V460 2
High temperature	Polyurea	100	2	-40...+180	Shell Gadus S5 T100 2
	Polyurea, EP	150	2	-40...+175	Mobil Polyrex EP2
	Polyurea	80	-	-40...+180	Klübersynth BQP 72-82
High-speed and spindle bearing grease	Polyurea	22	-	-50...+120	Klüberspeed BF 72-22
Low noise, high purity	Polyurea	72	-	-45...+180	Klüberquit BQ 72-72

When selecting a grease, following properties should be analyzed (thickener type, oil viscosity, operating conditions and application, NLGI grade -consistency).

Also, consult very carefully grease data sheet.

Oil lubrication

Oil lubrication can be used in any operating condition, but this kind of lubrication is compulsory when the value of the product $D_m * n$ from table 5.2 is exceeded for grease, namely $D_m * n > 500 \times 10^3$ and when high temperatures occur in bearing. Then, oil has to lubricate and to remove heat from bearing.

Oils used for bearing lubrication can be:
 - mineral oils, used up to a temperature of +150°C.

- synthetic oils, used up to a temperature of +220°C.

For a proper lubrication of bearings, low quantities of lubricants to reach the rolling elements are needed.

The lubricating systems must provide oil quantity necessary to prevent oil draining from bearing and heat removal in case of high speeds.

Most usual oil lubricating systems depending on factor $D_m * n$ are given in tables 5.8.

Oil lubricating systems				
Table 5.8				
Lubricating system	Operating conditions	Factor $D_m * n$	Oil viscosity at 40°C	Example in fig.
m ² /s				
Oil bath	Bath is filled up to the lowest rolling element for horizontal shaft and 70-80% of bath width for vertical shaft	$< 250 \times 10^3$	$(17...300) \times 10^{-6}$	5.3 a), b)
Oil bath with external circulation	Central tank, oil circulates under a pressure of 1,5 MPa. High speeds.	$< 600 \times 10^3$	$(45...175) \times 10^{-6}$	5,4
Oil injection	Oil is injected into the operating area under a pressure of 0,1...0,5 MPa, with flow capacity of 0,5...10 l/min depending on temperature. Heavy loads and high speeds.	$< 900 \times 10^3$	$(13,5...80) \times 10^{-6}$	5,5
Oil spot	Oil in air current under a pressure of (0,05...0,5) MPa, flow capacity of (0,5...4) m ³ /hour for small and medium sized bearings, heavy loads and high speeds.	$< 1200 \times 10^3$	$(10...45) \times 10^{-6}$	5,6

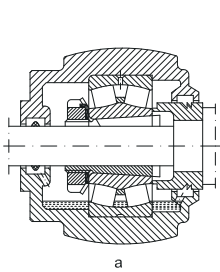

a

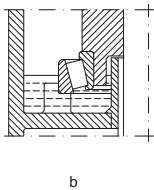

b

Fig. 5.3

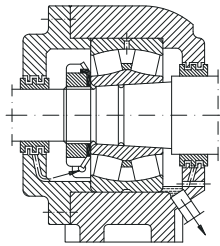

Fig. 5.4

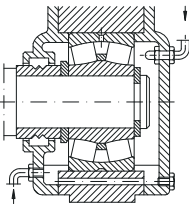

Fig. 5.5

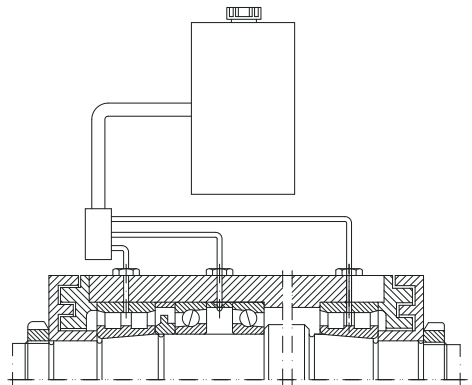

Fig. 5.6

Approximate values of oil kinematic viscosity at +40°C depending on the operating temperature are given in table 5.9.

Temperature t°C		Viscosity at 40°C, cSt
over	up to	
-	50	12...60
50	80	37...75,5
80	120	> 75,5
120	150	227

Diagram fig. 5.7 shows kinematic viscosity classes at 40°C in accordance with ISO, its variation depending on the operating temperature (t°C) in relation to speed and bearing mean diameter (Dm).

Example

A bearing 6204 is to operate under a speed $n = 2000$ r/min at a temperature $t = +65^{\circ}\text{C}$.

$D_m = 0,5 (d+D) = 35,5$ mm.

The viscosity of the oil for bearing lubrication is required.

From the diagram, for $D_m = 35,5$ mm, we can find viscosity at +65°C, $\nu_1 = 13$ cSt and viscosity at + 40°C, $\nu = 32$ cSt.

Table 5.10 shows oils which are recommended by ISO for bearing lubrication. Values of kinematic viscosity at +40°C, mm²/s are also given.

Class	Kinematic viscosity at +40°C, mm ² /s (cSt)			
	ISO	mean	low	high
ISO VG	2	2,2	1,98	2,42
ISO VG	3	3,2	2,88	3,52
ISO VG	5	4,6	4,14	5,06
ISO VG	7	6,8	6,12	7,48
ISO VG	10	10	9	11
ISO VG	15	15	13,5	16,5
ISO VG	22	22	19,8	24,2
ISO VG	32	32	28,8	35,2
ISO VG	46	46	41,4	50,6
ISO VG	68	68	61,2	74,8
ISO VG	100	100	90	110
ISO VG	150	150	135	165
ISO VG	220	220	198	242
ISO VG	320	320	288	352
ISO VG	460	460	414	506
ISO VG	680	680	612	748
ISO VG	1000	1000	900	1100
ISO VG	1500	1500	1350	1650

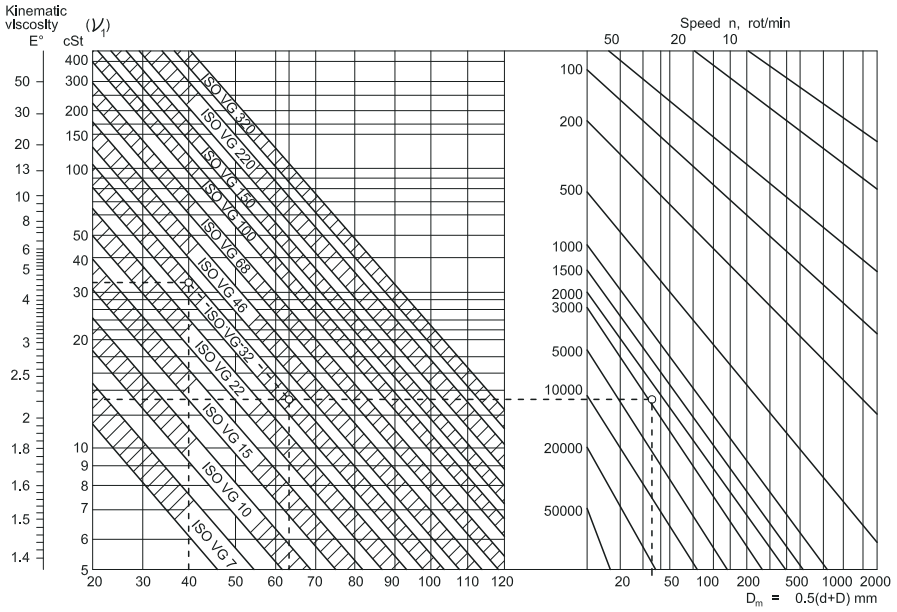

Fig. 5.7

Bearing designation

The purpose of designation is that of identification of bearings, so that bearings with the same designation to be interchangeable both dimensionally and operationally, no matter who the producers may be. Designation of ART rolling bearings are in

accordance with those used by world-know bearing companies: SKF, FAG , INA, KOYO etc.

The complete designation of a bearing consists of a basic design and may include one or more supplementary designations (prefixes and suffixes), as shown in chart fig. 6.1.

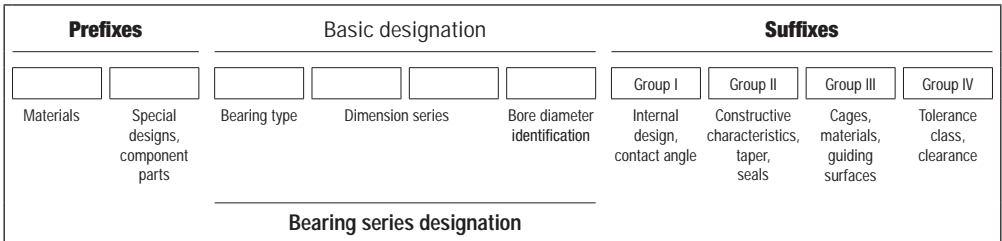

Fig. 6.1

The basic designation consists of an identification of the type of bearing (figure or letter), the series designation, in accordance with ISO and the bore diameter identification.

The designation of the bearing type and dimension series, for main standardized bearing types, is given in table 6.1.

Bore diameter identification consist of one, two or more figures as follows:

- bore diameter from 1 to 9 mm - one figure, representing the bore diameter (e.g. 623, 608);

- bore diameter from 10 to 495 mm - two figures, as follows: 00 for 10 mm, 01 for 12 mm, 02 for 15 mm, 03 for 17 mm, 04 and up to 99 for bore diameter from 20 to 495 mm. (bore diameter = bore diameter identification x 5, e.g. 6230, d=150 mm);

- bore diameter of 500 mm and over 500 mm

- is stated directly separated by a slash, the same applies to the values which are not perfect multiples of 5, or if they include a decimal point (e.g. 610/560, 62/32, 62/1,5).

Tapered roller bearings with inch dimensions listed in this catalogues make an exception from this rule.

Prefixes

Prefixes are letter-identifications which indicate the material, other than steel for bearings or component parts of bearing. The prefix for material is separated by a horizontal line from the rest of designation.

Prefixes for materials

- H** - heat-resisting steel (e.g. H - NUP 210)
- M** - copper alloy (e.g. M - 6008)
- S** - plastics, glass, ceramics etc. (e.g. S - 6204)
- T** - case-hardening steel (e.g. T - 35352)

Prefixes for special designs or parts of bearings















- K** - cage with rolling elements of dismountable bearing (e.g. KNU205)
- L** - free ring of dismountable bearing (e.g. LNU205) (interchangeable ring, e.g. L30205)
- R** - dismountable bearing without free ring (e.g. RNU205; RN205)
- E** - shaft washer of thrust ball bearing (e.g. E51210)
- W** - housing washer of thrust ball bearing (e.g. W51216)

Suffixes

Suffixes are used to identify various constructive modifications of the bearing in comparison to normal design. They are classified in four different groups, as follows:

- Group I - Modifications of internal design, design with increased basic load (e.g. A, C, E etc.), contact angle (e.g. A, B, C) and others.
- Group II - Modifications of external design, tapered bore, groove on outer ring etc. (e.g. 30205A, 1210K, 6210NR, 6310-2RS)
- Group III - Modifications of cage design, material, guiding surfaces etc. (e.g. 6205TN, NU310MA)
- Group IV - Modifications of normal design regarding tolerance classes, bearing radial or axial clearance, stability of dimensions at high temperatures, bearing matching etc. (e.g. 6206P5, 6310P53, NU210SO, 7010CDB).

These suffixes for bearing designation are listed considering the groups they belong to, at the beginning of each bearing group.

Designation of the type and dimension series for the standardized bearings			
Table 6.1			
Bearing design	Bearing type identification	Series designation	Example
	6	18 10 03 19 02 23 00 22 04	61952 6208
	1	10 03 02 23 22	1205 11210
	7	10 02 03	7030C 72108
	0	32 33	3207 33160
	NU	10 02 22 03	NU208
	NJ	23 04	NU2206
	N		N310 N5161M
	NUP		NUP209
	NNU	49	NNU4920
	NN	30	NN3015
	2	30 41 13 40 22 23 31 32	22216 25130
	3	29 22 23 20 03 02 13	32010 32208 34115
	5	11 13 12 14	51115 51212
	5	22 23 24	52205 52308

Mounting and dismounting

Proper operation of rolling bearings is also determined by a proper selection of the solution of mounting and dismounting, considering the type and size of bearing, fit, adequate tools for these operations, performance etc.

As being precision components, rolling bearings should be handled carefully when storing or mounting. Thus, the following conditions should be observed:

- storing in their original package, on special shelves, in dry room, temperature of $+18^{\circ}\text{C} \dots +20^{\circ}\text{C}$, maximum moisture degree of 60%
- handling bearings, while storing and mounting, should be carefully done so that original package to be protected and not to be deteriorated
- bearings should be unpacked only when they are to be mounted

They shouldn't be washed if original package hasn't been destroyed

- as the adjoin parts of bearing are accurate, without burrs, chips or hits, special care should be taken.

Mounting of bearings with cylindrical bore

Bearings with cylindrical bore which are to have tight fit on shaft or in housing respectively will be mounted by mechanical, thermic or hydraulic means.

The pressing force should be transmitted only by the ring which is pressed on the shaft or into the housing bore. Transmission by rolling bearings should be avoided as they can get deformed and premature damage can occur.

Special sleeves with one or two ribs, fig. 7.1, a and b are used when mounting small and medium-sized bearings, which are to be mounted with transition fit. In case of self-aligning ball bearings or spherical roller thrust bearings, a plate is mounted for a proper location of the outer rings, as shown in fig. 7.2.

Mechanical or hydraulic presses are used as shown in fig. 7.3, in case of serial production so that force can be continuously and gradually applied.

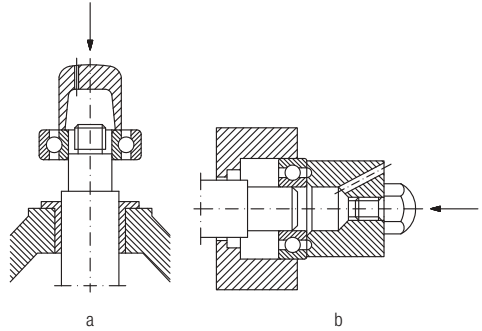

Fig. 7.1

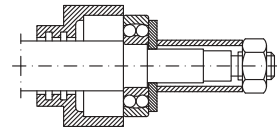

Fig. 7.2

For the mounting of bearings with clearance fit into the housing or on the shaft, the ring with transition or tight fit should be mounted first, after which the shaft-bearing assembly will be mounted into the housing as shown in fig. 7.4, a and b.

In case of dismountable bearings, rings can be mounted separately - fig. 7.5, even if a tight fit is required for both rings.

The mounting of medium ($d > 50 \text{ mm}$) and large-sized bearings with tight fit, requires much greater pressing forces. That's why in this case heating of bearings up to $+80^{\circ}\text{C} \dots +110^{\circ}\text{C}$ should be used instead of pressing, excepting shielded bearings, 2Z (2ZR) type and sealed bearings, 2RS (2RSR) type.

For the bearings heating, oil bath, electric range, heating device with thermic ring or induction heating device etc. can be used as shown in fig. 7.6, a-d.

The device with thermic ring - fig. 7.6 c consists of a split aluminum ring with three grips and cuts which

make it be elastic.

Thermic ring bore diameter is equal to inner ring raceway diameter of dismountable bearings.

The ring outside diameter can be calculated using the equation:

$$D_{ex} = \sqrt{4d_1^2 - 3d^2}$$

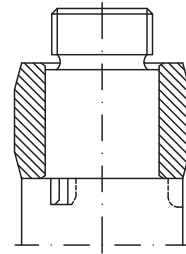

Fig. 7.5

where:

- D_{ex} = outside diameter of the thermic ring, mm
- d_1 = diameter of the inner ring raceway, mm
- d = bearing bore diameter, mm

The mass of the thermic ring is approximately equal to the mass of the bearing inner ring.

In case of large-sized cylindrical roller bearings, heating is done with induction devices. These devices consist of a coil inductor, thermal relays for temperature adjustment and timers. 380 V voltage and 50 - 60 Hz frequency inductors are used for bearings with bore diameter up to 200 mm.

For larger sized bearings, 20... 40 V voltage and 50 - 60 Hz inductors are used.

This device is schematically shown in fig. 7.6 d.

Mounting of bearings with tapered bore

Tapered bore bearings can be mounted directly on the shaft, on adapter sleeve or withdrawal sleeve. These bearings should always be mounted only with a tight fit. The tight fit can be done by an axial displacement of the bearing inner ring which

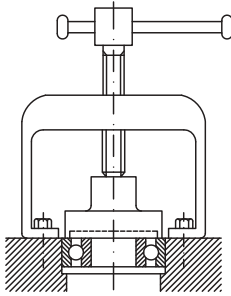

a

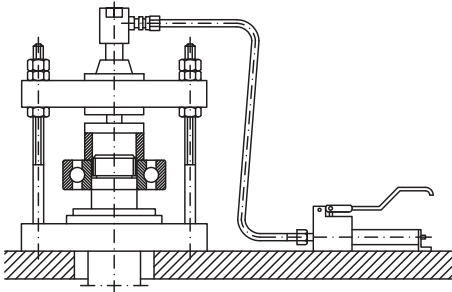

b

Fig. 7.3

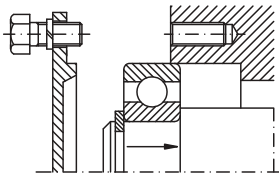

a

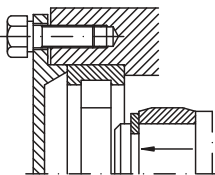

b

Fig. 7.4

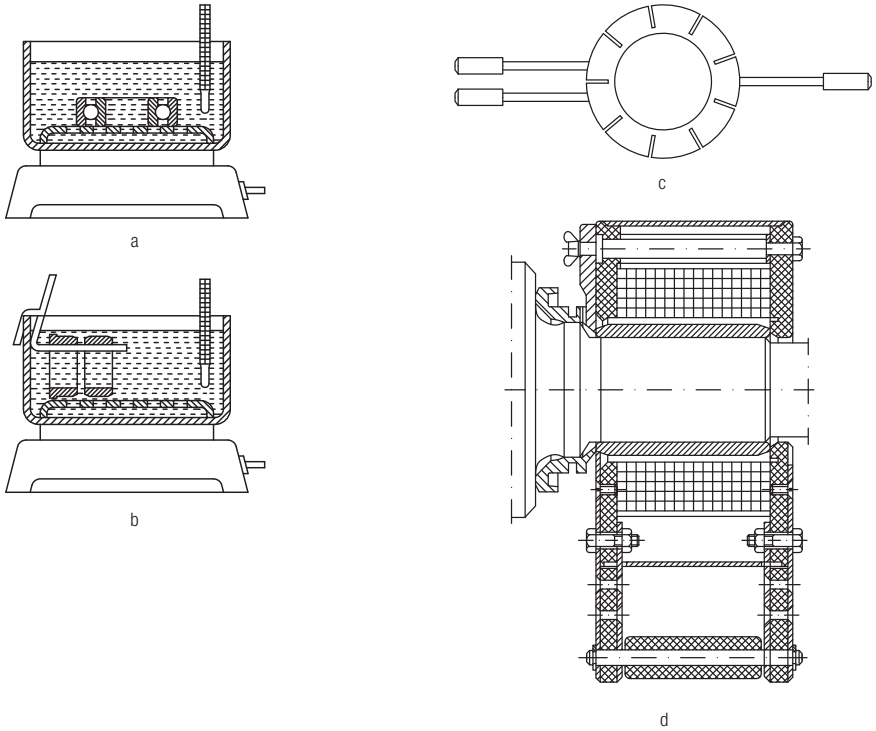

Fig. 7.6

Values for self-aligning ball bearings radial clearance, after mounting									
Values in mm									
Bore diameter d		Reduction of radial clearance		Axial displacement „a”, taper 1:12				Minimum radial clearance after mounting, in case of clearance group	
				on tapered shaft		on tapered sleeve			
over	up to	low	high	low	high	low	high	normal	C3
-	20	0,003	0,01	0,22	0,23	0,24	0,25	0,01	0,02
20	30	0,005	0,01	0,22	0,23	0,23	0,24	0,01	0,02
30	40	0,009	0,015	0,3	0,3	0,32	0,32	0,01	0,02
40	50	0,01	0,016	0,31	0,34	0,35	0,37	0,015	0,025
50	65	0,012	0,018	0,39	0,41	0,4	0,42	0,015	0,03
65	80	0,015	0,025	0,43	0,47	0,45	0,5	0,02	0,04
80	100	0,022	0,03	0,54	0,6	0,56	0,62	0,02	0,04
100	120	0,025	0,035	0,58	0,7	0,6	0,75	0,025	0,055

Table 7.1

is mounted directly on the tapered spindle of the shaft or by an axial displacement of the adapter or withdrawal sleeve.

The values of reduction in radial clearance are given in tables 7.1 and 7.2, as function of axial displacement on shaft of self-aligning ball bearings and spherical roller thrust bearings. After mounting the initial radial clearance is to be considered.

After mounting, radial clearance of radial and self-aligning ball bearings are in accordance with table 7.1.

The values of tightening are estimated by the values of the radial clearance reduction or of axial displacement. Axial displacement of the mounted bearings is measured by means of a limit gauge, as shown in fig. 7.7, a and b. The thickness of the limit gauge can be calculated from:

$$m = S - a$$

where:

m = thickness of the limit gauge, mm

S = distance initially measured, mm

a = axial displacement, from table 7.1, mm

Values for spherical roller bearings radial clearance, after mounting														
Values in mm														
Bore diameter d		Reduction of radial clearance		Axial displacement „a”, taper 1:12				Axial displacement „a”, taper 1:30				Minimum radial clearance after mounting, in case of clearance group		
				on tapered shaft		on tapered sleeve		on tapered shaft		on tapered sleeve				
over	up to	low	high	low	high	low	high	low	high	low	high	normal	C3	C4
30	40	0,02	0,025	0,35	0,4	0,35	0,45	-	-	-	-	0,015	0,025	0,04
40	50	0,025	0,03	0,4	0,45	0,45	0,5	-	-	-	-	0,02	0,03	0,05
50	65	0,03	0,04	0,45	0,6	0,5	0,7	-	-	-	-	0,025	0,035	0,055
65	80	0,04	0,05	0,6	0,75	0,7	0,85	-	-	-	-	0,025	0,04	0,07
80	100	0,045	0,06	0,7	0,9	0,75	1	1,7	2,2	1,8	2,4	0,035	0,05	0,08
100	120	0,05	0,07	0,7	1,1	0,8	1,2	1,9	2,7	2	2,8	0,05	0,065	0,1
120	140	0,065	0,09	1,1	1,4	1,2	1,5	2,7	3,5	2,8	3,6	0,055	0,08	0,11
140	160	0,075	0,1	1,2	1,6	1,3	1,7	3	4	3,1	4,2	0,055	0,09	0,13
160	180	0,08	0,11	1,3	1,7	1,4	1,9	3,2	4,2	3,3	4,6	0,06	0,1	0,15
180	200	0,09	0,13	1,4	2	1,5	2,2	3,5	4,5	3,6	5	0,07	0,1	0,16
200	225	0,1	0,14	1,6	2,2	1,7	2,4	4	5,5	4,2	5,7	0,08	0,12	0,18
225	250	0,11	0,15	1,7	2,4	1,8	2,6	4,2	6	4,6	6,2	0,09	0,13	0,2
250	280	0,12	0,17	1,9	2,6	2	2,9	4,7	6,7	4,8	6,9	0,1	0,14	0,22
280	315	0,13	0,19	2	3	2,2	3,2	5	7,5	5,2	7,7	0,11	0,15	0,24
315	355	0,15	0,21	2,4	3,4	2,6	3,6	6	8,2	6,2	8,4	0,12	0,17	0,26
355	400	0,17	0,23	2,6	3,6	2,9	3,9	6,5	9	6,8	9,2	0,13	0,19	0,29
400	450	0,2	0,26	3,1	4,1	3,4	4,4	7,7	10	8	10,2	0,13	0,2	0,31
450	500	0,21	0,28	3,3	4,4	3,6	4,8	8,2	11	8,4	11,2	0,16	0,23	0,35
500	560	0,24	0,32	3,7	5	4,1	5,4	9,2	12,5	9,6	12,8	0,17	0,25	0,36
560	630	0,26	0,35	4	5,4	4,4	5,9	10	13,5	10,4	14	0,2	0,29	0,41
630	710	0,3	0,4	4,6	6,2	5,1	6,8	11,5	15,5	12	16	0,21	0,31	0,45
710	800	0,34	0,45	5,3	7	5,8	7,6	13,3	17,5	13,6	18	0,23	0,35	0,51

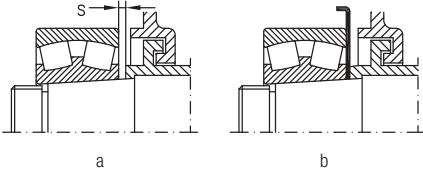

Fig. 7.7

Example

A bearing 22252, $d = 260$ mm, taper: 1:12, distance $S = 10$ mm, distance “a” from table 7.1 = 1,90 mm, $m = 10 - 1,9 = 8,10$ mm

Small-sized bearings with tapered bore which are to be mounted directly on the shaft or with adapter or withdrawal sleeves can be axially displaced by means of a nut as shown in fig. 7.8, a, or by means of a special sleeve as in fig. 7.8 b, c.

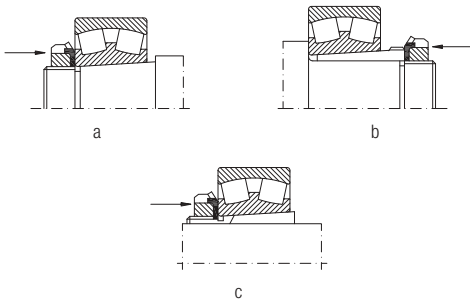

Fig. 7.8

Medium-sized bearings can be axially displaced by means of a special nut as shown in fig. 7.9 and some screws. Then, the nut is to be dismantled and replaced with a nut for axial fastening. Special hydraulic presses - fig. 7.11 are used to mount medium and large-sized bearings.

To reduce the bearing displacing force in case of large-sized bearings, pressurized oil is to be introduced between the tapered surfaces of the shaft spindle, bearing and b, by means of oil pump - fig. 7.10 or oil injector - fig. 7.12.

One or more grooves, should be provided as shown in fig. 7.13, a and b so that oil can be distributed between the mounting surfaces.

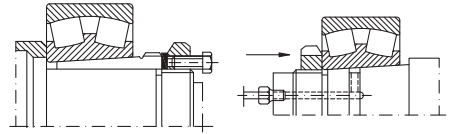

Fig. 7.9

Fig. 7.10

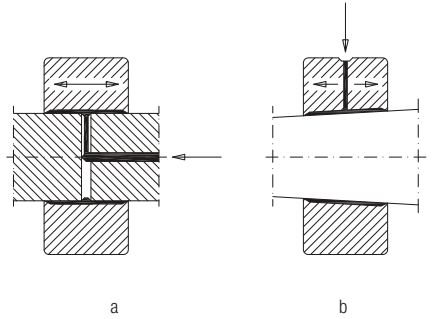

Fig. 7.11

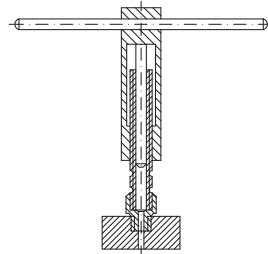

Fig. 7.12

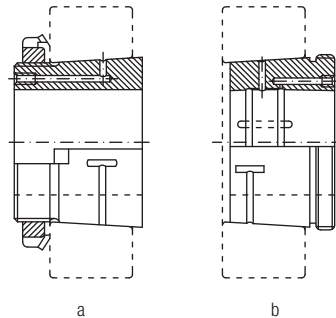

Fig. 7.13

Bearing dismounting

When bearings with tapered bore are to be dismounted from the shaft or housing, the succession of operations is inversely done than in case of mounting.

Thus, the assembly mounted with clearance fit or small tightening is to be dismounted first and then the parts mounted with greater tightening, as shown in fig. 7.14 and fig. 7.15.

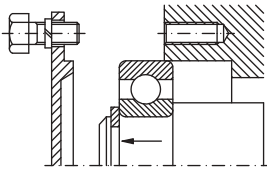

Fig. 7.14

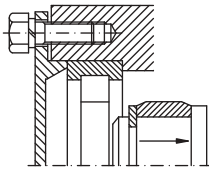
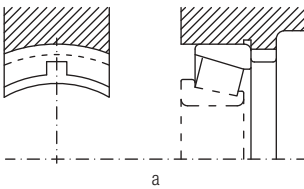
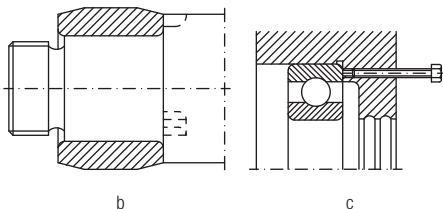

Fig. 7.15



a



b

c

Fig. 7.16

To use mechanical or hydraulic instruments, when dismounting bearings, a special design of the shaft and housing is required, as shown in fig. 7.16, a-c: withdrawal grooves (a) and (b), threaded bores (c), grooves for oil distribution, fig. 7.13.

Medium and small-sized bearings which are mounted with a tight fit are dismounted from the shaft by means of a soft steel or copper mandrel or by means of mechanical or hydraulic presses fig.7.17, a-c.

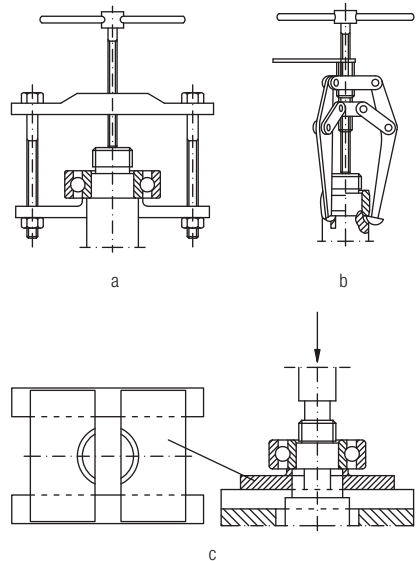

a

b

c

Fig. 7.17

To reduce the frictional force when dismounting large sized bearings which were mounted on shaft with tight fit, pressurized oil should be introduced, as in case of mounting - fig. 7.11.

To dismount bearings with tapered bore which were mounted directly on the shaft or bearings which were mounted with withdrawal or adapter sleeves, the nut axially fastened should be first stripped. Then, dismounting is to be done by light hammering on the inner ring by means of a soft steel or copper mandrel, as shown in fig. 7.18 a and b.

In case of bearings mounted with withdrawal sleeves, a nut is to be screwed up to the threaded

part provided for this purpose, as shown in fig. 7.19, a and b.

In case of large-sized bearings, hydraulic devices are used as in case of mounting.

Some solutions for dismounting bearings with tapered bore mounted directly on the shaft spindle, with adapter or withdrawal sleeve are given in fig. 7.20, a and b.

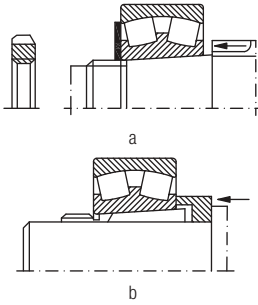

Fig. 7.18

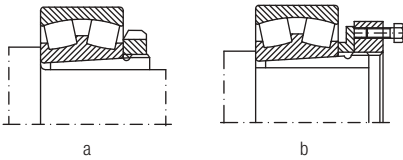

Fig. 7.19

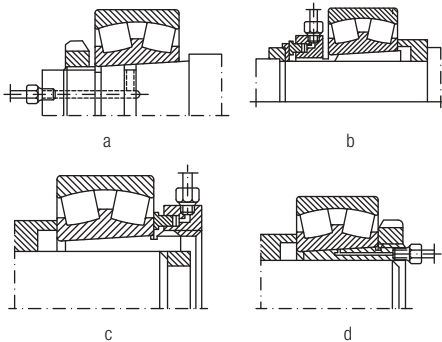

Fig. 7.20

ART **BEARINGS**



Deep groove ball bearings

Deep groove ball bearings are manufactured in a varied range, both of standard design and various constructive versions.

Deep groove ball bearings can take double direction radial and axial loads and also allow good operation at high speeds.

For these reasons, they can be widely used. Therefore, single row deep groove ball bearings are manufactured in many constructive versions as shown below.

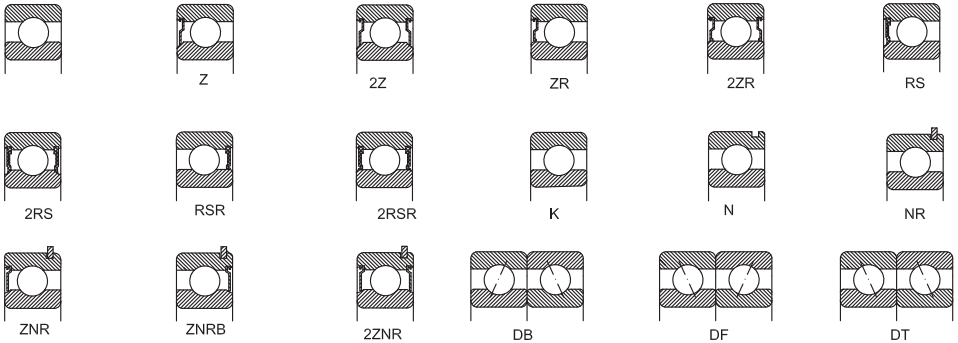

Besides deep groove ball bearings of basic design, bearings with UG design, with grooves on the outer ring and WL design, with grooves on both rings are also used for the purpose of mounting seals or shields on the bearings 2ZR, 2RSR or 2RS type, as shown in the bellow figure.

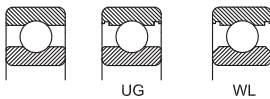

Suffixes

- A** - bearing with extended outer ring
- B** - bearing with extended inner ring
- C2** - radial clearance smaller than normal
- C3** - radial clearance larger than normal
- FA** - machined cage of steel or cast iron guided in the outer ring
- F2** - constructive modifications

- K** - bearing with tapered bore
- M** - machined cage of brass guided on the rolling elements
- MA** - machined cage of brass guided in the outer ring
- MB** - machined cage of brass guided on the inner ring
- N** - circular groove for snap ring on the outer ring
- NR** - circular groove on the outer ring and snap ring
- P0** - normal tolerance class (it is not marked)
- P6** - tolerance class more accurate than normal
- P63** - tolerance class P6 and radial clearance C3
- P5** - tolerance class more accurate than P6
- P4** - tolerance class more accurate than P5
- R** - rib on the outer ring
- RS** - bearing with seal on the side, with friction on the inner ring recess
- RSA** - bearing with special seal

- 2RS** - bearing with 2 seals, friction on the inner ring recess
- RSR** - bearing with seal on one side, friction on the rib of the inner ring
- 2RSR** - bearing with 2 seals, friction on the rib of the inner ring
- S0** - bearing which can operate up to a temperature of +150°C
- S1** - bearing which can operate up to a temperature of +200°C
- SP** - snap ring, diameter series 0, 2, 3, 4
- SR** - snap ring, diameter series 18 and 19
- T30** - bearing which can operate up to a temperature of +300°C, radial clearance 0,20...0,25 mm; phosphate-treated surfaces
- TN** - polyamide cage
- V** - bearing without cage
- Z** - bearing with shield and recess on the inner ring
- ZZ** - bearing with 2 shields and recess on the inner ring
- ZNRB** - bearing with shield and snap ring on the same side
- ZR** - bearing with shield, without recess on the inner ring
- ZZR** - bearing with 2 shields, without recess on the inner ring

Sealed and shielded deep groove ball bearings

ART manufactures two versions of sealed and shielded bearings, namely:

- bearings RS and Z type, with recess on the inner ring for sealing or shielding.
- bearings RSR and ZR type, when shielding and sealing respectively are done directly on the outside surface of the inner ring.

In case of bearings with non-rubbing shields, there is a small interstice between the shield and the rib of the inner ring; in case of bearings with seals, the gasoline and oil resistant elastic rubber lip rubs on the groove on the inner ring side or directly on the outside surface.

Bearings sealed and shielded on both sides manufactured in series are delivered filled with

lithium base grease and used at temperatures between -30°C and +110°C, in accordance with the specifications in chapter **Bearing lubrication**. Bearings can also be greased with special greases, relubrication not being necessary. Washing or heating are not allowed before bearing mounting in the assembly.

Bearings with shields have been designed first of all for cases when the inner ring rotates.

When the outer ring rotates, the lubricant can flow out of the bearing at a certain speed. In such cases, we recommend you to consult our experts.

Deep groove ball bearings with the snap ring groove

Deep groove ball bearings, with snap ring groove on the outer ring can be located in the housing with snap rings.

Because of their simple and space saving mounting, these bearings simplify the assembly design. The groove for the snap ring and the snap rings are in accordance with ISO 464 and tables 7 and 8 respectively.

Paired deep groove ball bearings

If the basic load of a single bearing is inadequate or the shaft has to be axially located in both directions with a certain clearance, paired deep groove ball bearings are recommended to be used.

These bearings can be delivered matched in pairs in three versions, as follows: DT (tandem arrangement), DB (back-to-back arrangement) or DF (face-to-face arrangement). They can be delivered with axial clearance or preloaded. The values of clearance or preload are given in table 2.

The producer marks "V" on the bearing outside surface as shown in next figure, so that paired bearings to be correctly mounted.

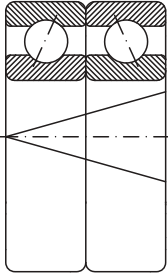

Tolerances

Deep groove ball bearings are generally manufactured to the normal tolerance class P0.

At request, they can also be manufactured to the tolerance classes P6, P5 or P4.

The values of tolerances are given in chapter **Bearing tolerances** on page 26.

Radial and axial clearance

Deep groove ball bearings are generally manufactured with normal radial clearance. At request, they can also be manufactured with radial clearance different from the normal one, according to ISO 5753. The values of radial clearance are given in table 1.

Paired bearings can be manufactured with axial clearance (suffix A) or preloaded (suffix L). Values for axial clearance and preload are given in table 2.

If a certain axial clearance is prescribed, this has to be measured and marked on the bearing by "A", followed by clearance actual value.

The multiple speed limit of these bearings can be calculated multiplying the speed of the basic bearing by 0,8.

Paired bearings are packed and delivered in the same box.

Dimensions

The overall dimensions of deep groove ball bearings are in accordance with the stipulations of ISO 15.

Misalignments

Deep groove ball bearings have limited abilities to compensate for bearing error of alignment. The permissible misalignment between the outer ring and the inner ring, which will not produce inadmissible high additional loads in the bearing, depends on the bearing size, operational radial clearance, inner bearing design and also on the magnitude of loads and moments acting upon the bearing.

Because of the complex relationship of these influence factors, definite and universally valid values of permissible misalignment cannot be determined. Considering the above mentioned factors, under normal operation conditions the permissible misalignments are between 2 and 10 minutes of arc, depending on the bearing series and load.

Radial clearance of deep groove ball bearings

Table 1

Bore diameter		Clearance group symbol for bearings with cylindrical bore									
d		C2		Normal		C3		C4		C5	
		Clearance group symbol for bearings with tapered bore									
-		C2		Normal		C3		C4			
over	up to	min.	max.	min.	max.	min.	max.	min.	max.	min.	max.
mm		µm									
2.5	10	0	7	2	13	8	23	14	29	20	37
10	18	0	9	3	18	11	25	18	33	25	45
18	24	0	10	5	20	13	28	20	36	28	48
24	30	1	11	5	20	13	28	23	41	30	53
30	40	1	11	6	20	15	33	28	46	40	64
40	50	1	11	6	23	18	36	30	51	45	73
50	65	1	15	8	28	23	43	38	61	55	90
65	80	1	15	10	30	25	51	46	71	65	105
80	100	1	18	12	36	30	58	53	84	75	120
100	120	2	20	15	41	36	66	61	97	90	140
120	140	2	23	18	48	41	81	71	114	105	160
140	160	2	23	18	53	46	91	81	130	120	180
160	180	2	25	20	61	53	102	91	147	135	200
180	200	2	30	25	71	63	117	107	163	150	230
200	225	2	35	25	85	75	140	125	195	175	265
225	250	2	40	30	95	85	160	145	225	205	300
250	280	2	45	35	105	90	170	155	245	225	340
280	315	2	55	40	115	100	190	175	270	245	370
315	355	3	60	45	125	110	210	195	300	275	410
355	400	3	70	55	145	130	240	225	340	315	460
400	450	3	80	60	170	150	270	250	380	350	520
450	500	3	90	70	190	170	300	280	420	390	570
500	560	10	100	80	210	190	330	310	470	440	630
560	630	10	110	90	230	210	360	340	520	490	700
630	710	20	130	110	260	240	400	380	570	540	780
710	750	20	140	120	290	270	450	430	630	600	860

Axial clearance and mounting preload of paired bearings series 60, 62, 63

Table 2

Bore diameter d		Axial clearance (suffix A)		Preload (suffix L)		
over	up to	min.	max.	Bearing series		
				60	62	63
mm		µm		N		
-	10	15	35	30	30	-
10	18	20	40	50	50	100
18	30	25	45	100	100	100
30	50	35	55	100	100	200
50	80	40	70	200	200	350
80	120	50	80	300	400	600
120	180	60	100	500	700	900
180	250	70	110	800	1000	1200

Cages

Deep groove ball bearings are generally fitted with cages of pressed steel sheet.

Cages of glass fiber reinforced polyamide 6.6 are also suitable if the operating temperature doesn't exceed +120°C. They have reduced mass, low coefficient of friction and are noiseless in operation. Large-sized bearings are fitted with machined brass cages.





Cage design and some technical data are given in table 3.

Bearing minimum radial load

A minimum load must be applied on a deep groove ball bearing so that they can operate correctly, especially in case of operating under heavy loads.

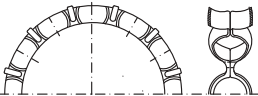
The forces of inertia which occur in bearing as well as the friction in lubricant influence negatively the operating conditions and can cause detrimental sliding movements between balls and raceways.

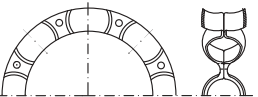
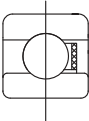
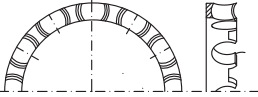
Table 3

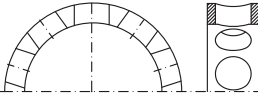
Cage	Design		Application	Max. value D _n	
	bearing	cage		oil	grease
Pressed cage of sheet with fins			<ul style="list-style-type: none"> - General application - Bearings with d>10 mm - Low frictional moment - Low inertia - Moderate speeds 	100x10 ³	550x10 ³
Pressed cage of riveted sheet			<ul style="list-style-type: none"> - General application - Bearings with d>10 mm - Low frictional moment - Low inertia - Moderate speeds 	1000x10 ³	550x10 ³
Polyamide cage			<ul style="list-style-type: none"> - General application - Low frictional - High speeds 	1400x10 ³	1100x10 ³
Brass machined cage			<ul style="list-style-type: none"> - General application - Bearings: <ul style="list-style-type: none"> 61836-618/1400 61936-619/950 16036-16072 6030-60/630 6230-6248 6320-6330 	1000x10 ³	800x10 ³

Minimum radial load depends on the bearing size, speed and lubricant viscosity at operating temperature. It can be roughly calculated from the equation:

$$F_{r \min} = 0,01 C_r \quad (C_r = \text{basic dynamic radial load}).$$

Equivalent dynamic radial load

Deep groove ball bearing can take also radial and axial combined loads.

For deep groove ball bearings, single or paired in tandem arrangement DT, equivalent dynamic radial load can be calculated using the equation:

$$P_r = F_r, \text{ kN, when } F_a/F_r < e$$

$$P_r = X F_r + Y F_a, \text{ kN, when } F_a/F_r > e$$

The greater the axial load, the greater the contact angle of these bearings.

Factor e, X and Y depend on the ratio $f_0 F_a / C_{Or}$

Factor f_0 can be determined using the diagram in the bellow figure, as a function of dimension series and mean diameter $(d+D)/2$. F_a is the axial and C_{Or} is the static basic load of the bearing.

The values of factors e, X, Y which depend on the bearing clearance can be determined from table 4, corresponding to the values of the ratio $f_0 F_a / C_{Or}$. The values in table 4 apply to bearings mounted with normal fit, i.e. shaft manufactured to tolerance class j5 or k5 and housing in J6, respectively.

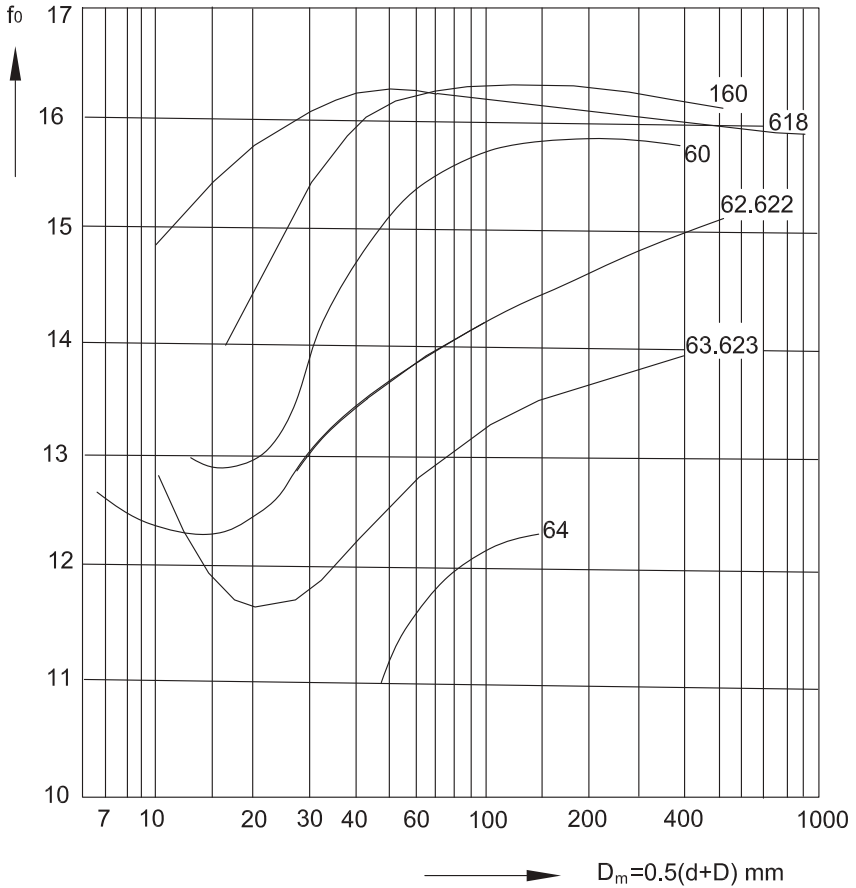

Calculation factors e, X and Z for deep groove ball bearings, single mounted or matched in tandem

Table 4

$f_0 F_{Dr} / C_{Dr}$	Normal radial clearance			Radial clearance C3			Radial clearance C4		
	e	X	Y	e	X	Y	e	X	Y
0,2	0,19	0,56	2,25	0,32	0,46	1,77	0,38	0,44	1,44
0,4	0,22	0,56	1,95	0,34	0,46	1,63	0,42	0,44	1,36
0,8	0,26	0,56	1,68	0,38	0,46	1,44	0,45	0,44	1,25
1,6	0,31	0,56	1,4	0,43	0,46	1,27	0,48	0,44	1,16
3	0,37	0,56	1,2	0,48	0,46	1,14	0,52	0,44	1,08
6	0,44	0,56	1,02	0,54	0,46	1	0,56	0,44	1

For bearings matched in DB or DT arrangement, equivalent dynamic radial load can be calculated using the equation:

$$P_r = F_r + Y_1 F_{a1}, \text{ kN when } F_a/F_r < e$$

$$P_r = 0,75F_r + Y_2 F_{a1}, \text{ kN when } F_a/F_r > e.$$

The values of factors e , Y_1 and Y_2 , as functions of ratio F_a/C_{Or} are given in table 5.

Calculation factors e , Y_1 , Y_2 for DB and DF arrangements			
$f_0 F_a/C_{Or}$	e	Y_1	Y_2
0,03	0,32	2	2,8
0,1	0,4	1,55	2,2
0,25	0,47	3	1,65

Equivalent static radial load

For deep groove ball bearings, single or matched in tandem (DT), equivalent static load can be calculated using the equations:

$$P_0 = F_r, \text{ kN, when } F_a/F_r < 0,8$$

$$P_0 = 0,6F_r + 0,5 F_{a1}, \text{ kN, when } F_a/F_r > 0,8$$

For bearings matched in DB or DF arrangement, it can be calculated from

$$P_0 = F_r + 1,7 F_{a1}, \text{ kN.}$$

Axial load

If deep groove ball bearings are pure axial loaded, the axial load should not exceed $0,5 C_{Or}$. In case of small-sized bearings and bearings of light series (diameter series 8, 9, 0 and 1), the axial load should not exceed $0,25 C_{Or}$.

Heavy axial loads cause a significant decrease of bearing rating life. In such cases, we recommend you to consult our experts.

Abutment dimensions

For a proper location of bearing rings on the shaft shoulder and housing, respectively, maximum shaft (housing) connection radius r_u max should be less than minimum bearing mounting chamfer r_s min.

The shoulder should have the proper height corresponding to maximum bearing mounting chamfer.

The values of the connection radius (r_u) and support shoulder height (h_u) as function of mounting chamfers are given in table 6.

Abutment dimension				
r_s min	r_u max	h_u min		
		Bearing series		
		618	161, 60,	64
		619, 160	62, 63	
0,15	0,15	0,4	0,7	-
0,2	0,2	0,7	0,9	-
0,3	0,3	1	1,2	-
0,6	0,6	1,6	2,1	-
1	1	2,3	2,8	-
1,1	1	3	3,5	4,5
1,5	1,5	3,5	4,5	5,5
2	2	4,4	5,5	6,5
2,1	2,1	5,1	6	7
3	2,5	6,2	7	8
4	3	7,3	8,5	10
5	4	9	10	12
6	5	11,5	13	15
7,5	6	14	-	-

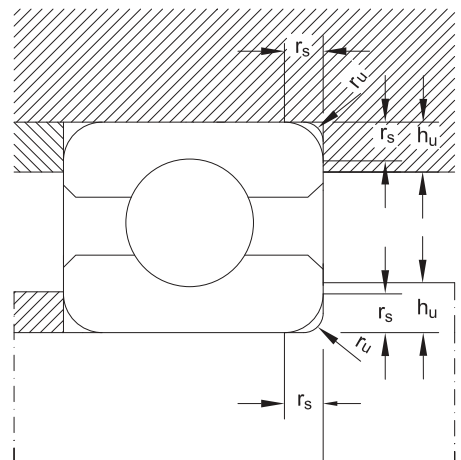

Snap ring groove and snap ring dimensions and tolerances

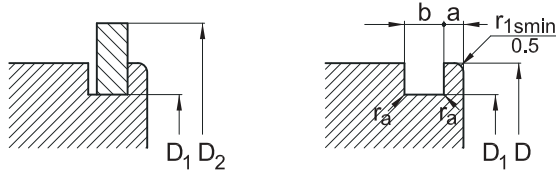

Snap ring groove

Table 7

Outer diameter D	Dimensions series									
	18				19				r _o	
	D ₁		a		a		b		nom.	toler.
	nom.	toler.	nom.	toler.	nom.	toler.	nom.	toler.	nom.	toler.
	mm									
22	20,8	-0,3	-	-	1,05	-0,15	0,8	+0,25	0,2	-0,1
24	22,8	-0,3	-	-	1,05	-0,15	0,8	+0,25	0,2	-0,1
28	26,7	-0,3	-	-	1,3	-0,15	0,95	+0,25	0,25	-0,12
30	28,7	-0,3	-	-	1,3	-0,15	0,95	+0,25	0,25	-0,12
32	30,7	-0,3	1,3	-0,15	-	-	0,95	+0,25	0,25	-0,12
34	32,7	-0,3	1,3	-0,15	-	-	0,95	+0,25	0,25	-0,12
37	35,7	-0,3	1,3	-0,15	1,7	-0,15	0,95	+0,25	0,25	-0,12
39	37,7	-0,3	-	-	1,7	-0,15	0,95	+0,25	0,25	-0,12
40	38,7	-0,3	1,3	-0,15	-	-	0,95	+0,25	0,25	-0,12
42	40,7	-0,3	1,3	-0,15	1,7	-0,15	0,95	+0,25	0,25	-0,12
44	42,7	-0,3	1,3	-0,15	-	-	0,95	+0,25	0,25	-0,12
45	43,7	-0,3	-	-	1,7	-0,15	0,95	+0,25	0,25	-0,12
47	45,7	-0,3	1,3	-0,15	1,7	-0,15	0,95	+0,25	0,25	-0,12
52	50,7	-0,3	1,3	-0,15	1,7	-0,15	0,95	+0,25	0,25	-0,12
55	53,7	-0,3	-	-	1,7	-0,15	0,95	+0,25	0,25	-0,12
58	56,7	-0,3	1,3	-0,15	-	-	0,95	+0,25	0,25	-0,12
62	60,7	-0,3	-	-	1,7	-0,15	0,95	+0,25	0,25	-0,12
65	63,7	-0,4	1,3	-0,15	-	-	0,95	+0,25	0,25	-0,12
68	66,7	-0,4	-	-	1,7	-0,15	0,95	+0,25	0,25	-0,12
72	70,7	-0,4	1,7	-0,15	1,7	-0,15	0,95	+0,25	0,25	-0,12
78	76,2	-0,4	1,7	-0,15	-	-	1,3	+0,3	0,4	-0,2
80	77,9	-0,4	-	-	2,1	-0,2	1,3	+0,3	0,4	-0,2
85	82,9	-0,4	1,7	-0,15	2,1	-0,2	1,3	+0,3	0,4	-0,2
90	87,9	-0,4	1,7	-0,15	2,1	-0,2	1,3	+0,3	0,4	-0,2
95	92,9	-0,4	1,7	-0,15	-	-	1,3	+0,3	0,4	-0,2
100	97,9	-0,4	1,7	-0,15	2,5	-0,2	1,3	+0,3	0,4	-0,2
105	102,6	-0,5	-	-	2,5	-0,2	1,3	+0,3	0,4	-0,2
110	107,6	-0,5	2,1	-0,2	2,5	-0,2	1,3	+0,3	0,4	-0,2
115	112,6	-0,5	2,1	-0,2	-	-	1,3	+0,3	0,4	-0,2
120	117,6	-0,5	2,1	-0,2	3,3	-0,2	1,3	+0,3	0,4	-0,2
125	122,6	-0,5	2,1	-0,2	3,3	-0,2	1,3	+0,3	0,4	-0,2
130	127,6	-0,5	2,1	-0,2	3,3	-0,2	1,3	+0,3	0,4	-0,2
140	137,6	-0,5	2,5	-0,2	3,3	-0,2	1,9	+0,3	0,6	-0,2
145	142,7	-0,5	-	-	3,3	-0,2	1,9	+0,3	0,6	-0,3
150	147,6	-0,5	2,5	-0,2	3,3	-0,2	1,9	+0,3	0,6	-0,3
165	161,8	-0,5	3,3	-0,2	3,7	-0,2	1,9	+0,3	0,6	-0,3
175	171,8	-0,5	3,3	-0,2	-	-	1,9	+0,3	0,6	-0,3
180	176,8	-0,5	-	-	3,7	-0,2	1,9	+0,3	0,6	-0,3
190	186,8	-0,5	3,3	-0,2	3,7	-0,2	1,9	+0,3	0,6	-0,3
200	196,8	-0,5	3,3	-0,2	-	-	1,9	+0,3	0,6	-0,3

The outer ring chamfer on the side of snap ring groove should allow a housing connection radius of:
 0,3 mm for dimensions series 18, up to D = 78 mm included and for dimensions series 19, up to D = 47 mm included;
 0,5 mm for dimensions series 18, for D > 78 mm and for dimensions series 19, for D > 47 mm

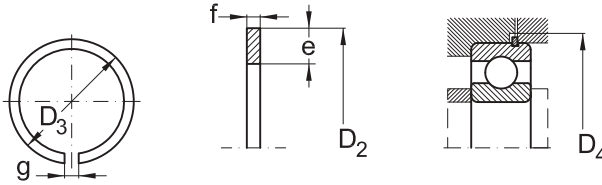

Snap ring

Table 7 (continue)

Outer diameter D	D ₂ ¹⁾			D ₃ ²⁾			D ₄	e	f	g	r	Mass	Snap ring designation
	max.	nom.	toler.	min.	nom.	nom.	nom.	min.					
mm												g	-
22	24,8	20,5	-0,3	25	2	0,7	2	0,2	0,812	SR22			
24	26,8	22,5	-0,3	28	2	0,7	2	0,2	0,886	SR24			
28	30,8	26,4	-0,3	32	2,05	0,85	3	0,2	1,269	SR28			
30	32,8	28,3	-0,3	34	2,05	0,85	3	0,2	1,39	SR30			
32	34,8	30,3	-0,3	36	2,05	0,85	3	0,2	1,483	SR32			
34	36,8	32,3	-0,3	38	2,05	0,85	3	0,2	1,577	SR34			
37	39,8	35,3	-0,3	41	2,05	0,85	3	0,2	1,718	SR37			
39	41,8	37,3	-0,3	43	2,05	0,85	3	0,2	1,811	SR39			
40	42,8	38,3	-0,3	44	2,05	0,85	3	0,2	1,858	SR40			
42	44,8	40,3	-0,4	46	2,05	0,85	3	0,2	1,952	SR42			
44	46,8	42,3	-0,4	48	2,05	0,85	4	0,2	2,032	SR44			
45	47,8	43,3	-0,4	49	2,05	0,85	4	0,2	2,079	SR45			
47	49,8	45,3	-0,4	51	2,05	0,85	4	0,2	2,173	SR47			
52	54,8	50,3	-0,4	56	2,05	0,85	4	0,2	2,407	SR52			
55	57,8	53,3	-0,4	59	2,05	0,85	4	0,2	2,547	SR55			
58	60,8	56,3	-0,6	62	2,05	0,85	4	0,2	2,688	SR58			
62	64,8	60,2	-0,6	66	2,05	0,85	4	0,2	2,938	SR62			
65	67,8	63,2	-0,6	69	2,05	0,85	4	0,2	3,081	SR65			
68	70,8	66,2	-0,6	72	2,05	0,85	5	0,2	3,212	SR68			
72	74,8	70,2	-0,6	76	2,05	0,85	5	0,2	3,403	SR72			
78	82,7	75,7	-0,6	84	3,25	1,12	5	0,4	7,462	SR78			
80	84,4	77,4	-0,6	86	3,25	1,12	5	0,4	7,625	SR80			
85	89,4	82,4	-0,6	91	3,25	1,12	5	0,4	8,105	SR85			
90	94,4	87,4	-0,6	96	3,25	1,12	5	0,4	8,585	SR90			
95	99,4	92,4	-0,6	101	3,25	1,12	5	0,4	9,065	SR95			
100	104,4	97,4	-0,6	106	3,25	1,12	5	0,4	9,545	SR100			
105	110,7	101,9	-0,8	112	4,04	1,12	5	0,4	12,653	SR105			
110	115,7	106,9	-0,8	117	4,04	1,12	5	0,4	13,257	SR110			
115	120,7	111,9	-0,8	122	4,04	1,12	5	0,4	13,861	SR115			
120	125,7	116,9	-0,8	127	4,04	1,12	7	0,4	14,393	SR120			
125	130,7	121,8	-0,8	132	4,04	1,12	7	0,4	15,164	SR125			
130	135,7	126,8	-0,8	137	4,04	1,12	7	0,4	15,774	SR130			
140	145,7	136,8	-1	147	4,04	1,7	7	0,4	25,796	SR140			
145	150,7	141,8	-1	152	4,04	1,7	7	0,6	26,722	SR145			
150	155,7	146,8	-1,2	157	4,04	1,7	7	0,6	27,648	SR150			
165	171,5	161	-1,2	173	4,85	1,7	7	0,6	35,89	SR165			
175	181,5	171	-1,2	183	4,85	1,7	10	0,6	37,883	SR175			
180	186,5	176	-1,2	187	4,85	1,7	10	0,6	38,976	SR180			
190	196,5	186	-1,4	198	4,85	1,7	10	0,6	41,162	SR190			
200	206,5	196	-1,4	208	4,85	1,7	10	0,6	43,348	SR200			

¹⁾ D₂ dimensions refers to the mounted snap ring

²⁾ D₃ represents dimensions before mounting

Snap ring groove and snap ring dimensions and tolerances

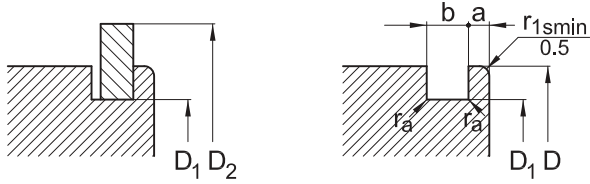

Snap ring groove Table 8										
Outer diameter D	Dimensions series									
	60				62, 63, 64					
	D ₁		a		a		b		r ₀	
	nom.	toler.	nom.	toler.	nom.	toler.	nom.	toler.	nom.	toler.
	mm									
30	28,17	-0,25	-	-	2,06	-0,16	1,35	+0,3	0,4	-0,2
32	30,15	-0,25	2,06	-0,16	2,06	-0,16	1,35	+0,3	0,4	-0,2
35	33,17	-0,25	2,06	-0,16	2,06	-0,16	1,35	+0,3	0,4	-0,2
40	38,1	-0,25			2,06	-0,16	1,35	+0,3	0,4	-0,2
42	39,75	-0,25	2,06	-0,16	2,06	-0,16	1,35	+0,3	0,4	-0,2
47	44,6	-0,25	2,06	-0,16	2,46	-0,15	1,35	+0,3	0,4	-0,2
52	49,73	-0,25	2,06	-0,16	2,46	-0,15	1,35	+0,3	0,4	-0,2
55	52,6	-0,25	2,08	-0,2	-	-	1,35	+0,3	0,4	-0,2
62	59,61	-0,5	2,08	-0,2	3,28	-0,21	1,9	+0,3	0,6	-0,3
68	64,82	-0,5	2,49	-0,2	3,28	-0,21	1,9	+0,3	0,6	-0,3
72	68,81	-0,5	-	-	3,28	-0,21	1,9	+0,3	0,6	-0,3
75	71,83	-0,5	2,49	-0,2	3,28	-0,21	1,9	+0,3	0,6	-0,3
80	76,81	-0,5	2,49	-0,2	3,28	-0,21	1,9	+0,3	0,6	-0,3
85	81,81	-0,5	-	-	3,28	-0,21	1,9	+0,3	0,6	-0,3
90	86,79	-0,5	2,87	-0,2	3,28	-0,21	2,7	+0,3	0,6	-0,3
95	91,82	-0,5	2,87	-0,2	-	-	2,7	+0,3	0,6	-0,3
100	96,8	-0,5	2,87	-0,2	3,28	-0,21	2,7	+0,3	0,6	-0,3
110	106,81	-0,5	2,87	-0,2	3,28	-0,21	2,7	+0,3	0,6	-0,3
115	111,81	-0,5	2,87	-0,2	-	-	2,7	+0,3	0,6	-0,3
120	115,21	-0,5	-	-	4,06	-0,21	3,1	+0,3	0,6	-0,3
125	120,22	-0,5	2,87	-0,2	4,06	-0,2	3,1	+0,3	0,6	-0,3
130	125,22	-0,5	2,87	-0,2	4,06	-0,2	3,1	+0,3	0,6	-0,3
140	135,23	-0,5	3,71	-0,26	4,9	-0,25	3,1	+0,3	0,6	-0,3
145	140,23	-0,5	3,71	-0,26	-	-	3,1	+0,3	0,6	-0,3
150	145,24	-0,5	3,71	-0,26	4,9	-0,25	3,1	+0,3	0,6	-0,3
160	155,22	-0,5	3,71	-0,26	4,9	-0,25	3,1	+0,3	0,6	-0,3
170	163,65	-0,5	3,71	-0,26	5,69	-0,25	3,5	+0,3	0,6	-0,3
180	173,66	-0,5	3,71	-0,26	5,69	-0,25	3,5	+0,3	0,6	-0,3
200	193,65	-0,5	5,69	-0,25	5,69	-0,25	3,5	+0,3	0,6	-0,3

The outer ring chamfer on the side of snap ring groove should allow a housing connection radius of:
 0,3 mm for dimensions series 18, up to D = 78 mm included and for dimensions series 19, up to D = 47 mm included;
 0,5 mm for dimensions series 18, for D > 78 mm and for dimensions series 19, for D > 47 mm

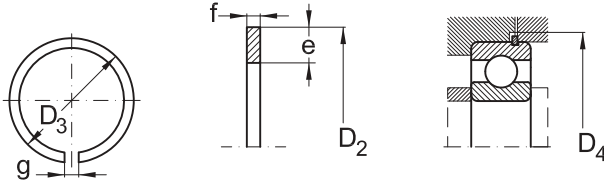

Snap ring

Table 8 (continue)

Outer diameter D	D ₂ ¹⁾	D ₃ ²⁾		D ₄	e	f	g	r	Mass	Snap ring designation
	max.	nom.	toler.	min.	nom.	nom.	nom.	min.		
mm									g	-
30	34,7	27,9	-0,4	36	3,25	1,12	3	0,4	2,78	SP30
32	36,7	29,9	-0,4	38	3,25	1,12	3	0,4	2,98	SP32
35	39,7	32,9	-0,4	41	3,25	1,12	3	0,4	3,22	SP35
40	44,6	37,8	-0,4	46	3,25	1,12	3	0,4	3,6	SP40
42	46,3	39,5	-0,5	47	3,25	1,12	3	0,4	3,75	SP42
47	52,7	44,3	-0,5	54	4,04	1,12	4	0,4	5,3	SP47
52	57,9	49,4	-0,5	59	4,04	1,12	4	0,4	5,92	SP52
55	60,7	52,3	-0,5	62	4,04	1,12	4	0,4	6,17	SP55
62	67,7	59	-0,6	69	4,04	1,7	4	0,6	10,5	SP62
68	74,6	64,2	-0,6	76	4,85	1,7	5	0,6	12,6	SP68
72	78,6	68,2	-0,6	80	4,85	1,7	5	0,6	14,7	SP72
75	81,6	71,2	-0,6	83	4,85	1,7	5	0,6	15,3	SP75
80	86,6	76,2	-0,6	88	4,85	1,7	5	0,6	16,3	SP80
85	91,6	81,2	-0,6	93	4,85	1,7	5	0,6	17,5	SP85
90	96,5	86,2	-0,6	98	4,85	2,46	5	0,6	26,6	SP90
95	101,6	91,2	-0,6	103	4,85	2,46	5	0,6	28,2	SP95
100	106,5	96,2	-0,8	108	4,85	2,46	5	0,6	29,2	SP100
110	116,6	106,2	-0,8	118	4,85	2,46	5	0,6	32,8	SP110
115	121,6	111,2	-0,8	123	4,85	2,46	5	0,6	34,4	SP115
120	129,7	114,6	-0,8	131	7,21	2,82	7	0,6	60,6	SP120
125	134,7	119,6	-0,8	136	7,21	2,82	7	0,6	63	SP125
130	139,7	124,6	-0,8	141	7,21	2,82	7	0,6	65,6	SP130
140	149,7	134,6	-1,2	151	7,21	2,82	7	0,6	70,6	SP140
145	154,7	139,6	-1,2	156	7,21	2,82	7	0,6	73	SP145
150	159,7	144,5	-1,2	161	7,21	2,82	7	0,6	77,2	SP150
160	169,7	154,5	-1,2	172	7,21	2,82	7	0,6	81	SP160
170	182,9	162,9	-1,2	185	9,6	3,1	10	0,6	122	SP170
180	192,9	172,8	-1,2	195	9,6	3,1	10	0,6	128	SP180
200	212,9	192,8	-1,4	215	9,6	3,1	10	0,6	148	SP200

¹⁾ D₂ dimensions refers to the mounted snap ring
²⁾ D₃ represents dimensions before mounting

Single Row Deep Groove Ball Bearings

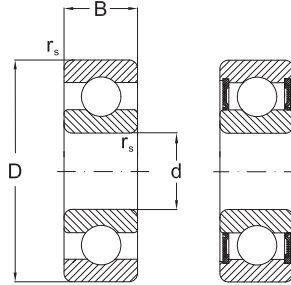

2RSR

Dimensions				Basical radial load		Speed limit		Designation		Mass
d	D	B	r_s min	dyn. C_r	stat. C_{0r}	grease	oil	bearing	snap ring	
mm				kN		min ⁻¹		-		kg
3	10	4	0,1	0,64	0,23	40000	48000	623		0,002
	10	4	0,1	0,64	0,23	40000		623 2ZR		0,002
4	13	5	0,2	1,3	0,49	38000	45000	624		0,003
	13	5	0,2	1,3	0,49	38000		624 2ZR		0,003
	16	5	0,3	1,2	0,5	34000	40000	634		0,005
	16	5	0,3	1,2	0,5	34000		634 2ZR		0,005
5	11	3	0,1	0,64	0,26	55000	65000	618/5		0,001
	16	5	0,3	1,9	0,69	34000	40000	625		0,005
	16	5	0,3	1,9	0,69	34000		625 2ZR		0,005
	16	5	0,3	1,9	0,69	22000		625 2RSR		0,005
	19	6	0,3	1,7	0,72	32000	38000	635		0,009
	19	6	0,3	1,7	0,72	32000		635 2ZR		0,009
6	13	3,5	0,1	1	0,44	50000	59000	618/6		0,002
	15	5	0,2	1,45	0,6	47000	56000	619/6		0,004
	19	6	0,3	2,2	0,89	32000	38000	626		0,008
	19	6	0,3	2,2	0,89	32000		626 2ZR		0,008
	19	6	0,3	2,2	0,89	22000		626 2RSR		0,008
7	14	3,5	0,1	0,96	0,4	47000	56000	618/7		0,002
	17	5	0,3	2,1	0,8	44000	51000	619/7 Y		0,005
	19	6	0,3	2,25	0,89	32000	38000	607		0,008
	19	6	0,3	2,25	0,89	32000		607 2ZR		0,008
	19	6	0,3	2,25	0,89	22000		607 2RSR		0,008
	22	7	0,3	3,3	1,35	30000	36000	627		0,012
	22	7	0,3	3,3	1,35	30000		627 2ZR		0,012
	22	7	0,3	3,3	1,35	20000		627 2RSR		0,012
8	16	4	0,2	1,35	0,57	44000	51000	618/8		0,003
	19	6	0,3	1,6	0,74	40000	47000	619/8		0,007
	22	7	0,3	3,3	1,35	30000	36000	608		0,015
	22	7	0,3	3,3	1,35	30000		608 2ZR		0,015
	22	7	0,3	3,3	1,35	20000		608 2RSR		0,015
9	17	4	0,2	1,45	0,64	40000	47000	618/9		0,003
	20	6	0,3	2,65	1,1	37000	43000	619/9		0,007
	24	7	0,3	3,35	1,4	30000	36000	609		0,018
	24	7	0,3	3,35	1,4	30000		609 2ZR		0,018

Single Row Deep Groove Ball Bearings

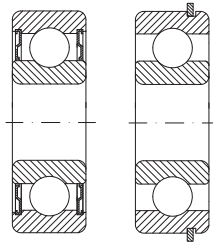

2ZR

NR

d	Dimensions			Basical radial load		Speed limit		Designation		Mass
	D	B	r_s min	dyn. C_r	stat. C_{0r}	grease	oil	bearing	snap ring	
mm				kN		min ⁻¹		-		kg
9	24	7	0,3	3,35	1,4	20000		609 2RSR		0,018
	26	8	0,3	4,55	1,95	28000	34000	629		0,02
	26	8	0,3	4,55	1,95	28000		629 2ZR		0,02
10	26	8	0,3	4,55	1,95	18000		629 2RSR		0,02
	19	5	0,3	1,7	0,83	37000	43000	61800		0,005
	22	6	0,3	1,95	0,75	34000	41000	61900 TN		0,01
	26	8	0,3	4,6	1,95	28000	34000	6000 TN		0,02
	26	8	0,3	4,6	1,95	28000		6000 2ZR		0,02
	26	8	0,3	4,6	1,95	17000		6000 2RSR		0,02
	28	8	0,3	4,6	1,95	28000	34000	16100		0,023
	30	9	0,6	5,1	2,4	26000	32000	6200 TN		0,032
	30	9	0,6	5,1	2,4	26000		6200 2ZR		0,032
	30	9	0,6	5,1	2,4	17000		6200 2RSR		0,032
	30	14	0,6	5,1	2,4	17000		62200 2RSR		0,047
	35	11	0,6	8,1	3,45	20000	26000	6300		0,057
	35	11	0,6	8,2	3,5	20000		6300 2ZR		0,057
35	11	0,6	8,2	3,5	15000		6300 2RSR		0,057	
35	17	0,6	8,2	3,5	10000		62300 2RSR		0,063	
12	21	5	0,3	1,8	0,95	33000	39000	61801		0,006
	21	5	0,3	1,45	0,67	33000	39000	61801 NR	SR21	0,006
	24	6	0,3	2,9	1,45	31000	36000	61901		0,011
	24	6	0,3	2,9	1,45	31000	36000	61901 NR	SR24	0,011
	28	8	0,3	5,1	2,4	26000	32000	6001		0,022
	28	8	0,3	5,1	2,4	26000	32000	6001 TN		0,022
	28	8	0,3	5,1	2,4	26000		6001 2ZR		0,022
	28	8	0,3	5,1	2,4	17000		6001 2RSR		0,022
	30	8	0,3	5,1	2,4	26000	32000	16101		0,026
	32	10	0,6	6,9	3,1	22000	28000	6201		0,037
	32	10	0,6	6,9	3,1	22000	28000	6201 TN		0,037
	32	10	0,6	6,9	3,1	22000		6201 2ZR		0,037
	32	10	0,6	6,9	3,1	15000		6201 2RSR		0,037
	32	14	0,6	6,9	3,1	22000		62201 2RSR		0,049
	37	12	1	9,8	4,2	19000	24000	6301		0,065
37	12	1	9,8	4,2	19000		6301 2ZR		0,065	
37	12	1	9,8	4,2	12000		6301 2RSR		0,065	

Single Row Deep Groove Ball Bearings

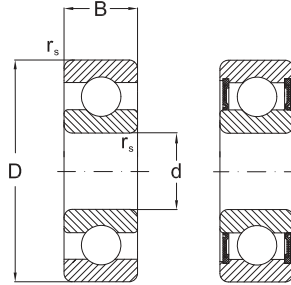

2RSR

Dimensions				Basical radial load		Speed limit		Designation		Mass
d	D	B	r _s min	dyn. C _r	stat. C _{0r}	grease	oil	bearing	snap ring	
mm				kN		min ⁻¹		-		kg
12	37	17	1	9,8	4,2	12000		62301 2RSR		0,07
	24	5	0,3	2	1,25	28000	33000	61802		0,007
	24	5	0,3	2	1,25	28000	33000	61802 NR	SR24	0,007
	28	7	0,3	4	2,05	26000	30000	61902		0,017
	28	7	0,3	4	2,05	26000	30000	61902 NR	SR28	0,017
	30	8	0,3	4	2,05	22000	28000	16002		0,037
	32	9	0,3	5,6	2,9	22000	28000	6002		0,031
	32	9	0,3	5,6	2,9	22000		6002 2ZR		0,031
	32	9	0,3	5,6	2,9	14000		6002 2RSR		0,031
	35	11	0,6	7,8	3,8	19000	24000	6202		0,046
	35	11	0,6	7,8	3,8	19000		6202 2ZR		0,046
	35	11	0,6	7,65	3,75	19000	24000	6202 TN		0,046
	35	11	0,6	7,8	3,8	13000		6202 2RSR		0,046
	35	14	0,6	7,8	3,8	13000		62202 2RSR		0,053
15	42	13	1	11,5	5,5	17000	20000	6302		0,092
	42	13	1	11,5	5,5	17000		6302 2ZR		0,092
	42	13	1	11,5	5,5	11000		6302 2RSR		0,092
	42	17	1	11,5	5,5	17000		62302 2RSR		0,099
	26	5	0,3	2,2	1,4	26000	32000	61803		0,009
	30	7	0,3	4,35	2,3	26000	30000	61903		0,018
	35	8	0,3	6	3,25	20000	26000	16003		0,04
	35	10	0,3	6	3,3	20000	26000	6003		0,042
	35	10	0,3	6	3,3	20000		6003 2ZR		0,042
	35	10	0,3	6	3,3	12000		6003 2RSR		0,042
17	40	12	0,6	9,6	4,8	17000	20000	6203		0,07
	40	12	0,6	9,6	4,8	17000	20000	6203 TN		0,07
	40	12	0,6	9,6	4,8	17000		6203 2ZR		0,07
	40	12	0,6	9,6	4,8	11000		6203 2RSR		0,07
	40	12	0,6	9,6	4,8	17000	20000	6203 NR	SP40	0,07
	40	16	1	9,6	4,8	17000		62203 2RSR		0,082
	47	14	1	13,7	6,7	16000	19000	6303		0,12
	47	14	1	13,7	6,7	16000		6303 2ZR		0,12
	47	14	1	13,7	6,7	10000		6303 2RSR		0,12
	47	19	1	13,4	6,55	16000		62303 2RSR		0,145
	62	17	1,1	22,7	11	12000	15000	6403		0,285

Single Row Deep Groove Ball Bearings

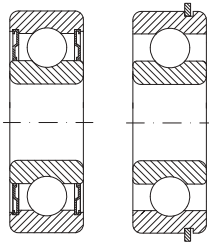

2ZR

NR

d	Dimensions			Basical radial load		Speed limit		Designation		Mass
	D	B	r_s min	dyn. C_r	stat. C_{0r}	grease	oil	bearing	snap ring	
mm				kN		min ⁻¹		-		kg
17	62	17	1,1	22,7	11	12000	15000	6403 NR	SP62	0,285
	37	9	0,3	6,55	3,65	19000	23000	61904		0,036
	37	9	0,3	6,55	3,65	19000	23000	61904 NR	SR37	0,036
	42	8	0,3	7,95	4,5	17000	20000	16004		0,05
	42	12	0,6	9,4	5,1	17000	20000	6004		0,07
	42	12	0,6	9,4	5,1	17000		6004 2ZR		0,07
	42	12	0,6	9,4	5,1	11000		6004 2RSR		0,07
	47	14	1	12,8	6,7	15000	18000	6204		0,118
	47	14	1	12,8	6,7	15000	18000	6204 TN		0,118
	47	14	1	12,8	6,7	15000		6204 2ZR		0,118
	47	14	1	12,8	6,7	10000		6204 2RSR		0,118
	47	14	1	12,8	6,7	15000	18000	6204 NR	SP47	0,118
	47	18	1	12,8	6,7	15000		62204 2RSR		0,131
	52	15	1,1	15,9	7,9	13000	16000	6304		0,158
	52	15	1,1	15,9	7,9	13000	16000	6304 TN		0,158
	52	15	1,1	15,9	7,9	13000	16000	6304 MAP5		0,158
	52	15	1,1	15,9	7,9	13000		6304 2ZR		0,158
52	15	1,1	15,9	7,9	8000		6304 2RSR		0,158	
52	15	1,1	15,9	7,9	13000	16000	6304 NR	SP52	0,158	
52	21	1,1	15,9	7,9	13000		62304 2RSR		0,197	
72	19	1,1	31	15,2	10000	13000	6404		0,42	
22	50	14	1	12,9	6,8	15000	18000	62/22		0,118
	50	14	1	12,9	6,8	15000		62/22 2ZR		0,118
	50	14	1	12,9	6,8	15000		62/22 2RSR		0,118
	56	16	1,1	18,5	9,5	13000	16000	63/22		0,201
	56	16	1,1	18,5	9,5	13000		63/22 2ZR		0,201
	56	16	1,1	18,5	9,5	13000		63/22 2RSR		0,201
25	37	7	0,3	4,35	2,6	18000	25000	61805		0,022
	42	9	0,3	6,65	4,1	16000	19000	61905		0,041
	47	8	0,3	8,4	5,1	15000	18000	16005		0,058
	47	12	0,6	10,1	5,9	15000	18000	6005 TN		0,086
	47	12	0,6	10,1	5,9	15000		6005 2ZR		0,086
	47	12	0,6	10,1	5,9	9500		6005 2RSR		0,086
	52	15	1	14	7,9	12000	15000	6205		0,142
	52	15	1	14	7,9	12000		6205 2ZR		0,142

Single Row Deep Groove Ball Bearings

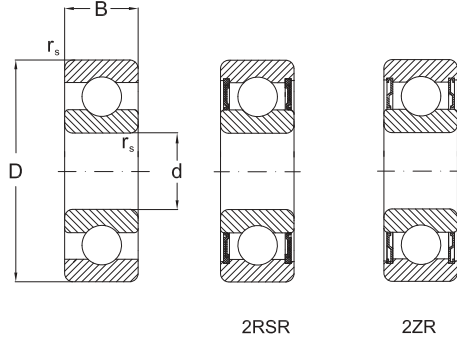

Dimensions				Basical radial load		Speed limit		Designation		Mass
d	D	B	r _s min	dyn. C _r	stat. C _{0r}	grease	oil	bearing	snap ring	
mm				kN		min ⁻¹		-		kg
25	52	15	1	14	7,9	8000		6205 2RSR		0,142
	52	15	1	14	7,9	12000	15000	6205 NR	SP52	0,142
	52	18	1	14	7,9	12000		62205 2RSR		0,148
	62	17	1,1	20,6	11,3	11000	14000	6305		0,25
	62	17	1,1	20,6	11,3	11000	14000	6305 MAP5		0,25
	62	17	1,1	20,6	11,3	11000		6305 2ZR		0,25
	62	17	1,1	20,6	11,3	7500		6305 2RSR		0,25
	62	17	1,1	20,6	11,3	11000	14000	6305 NR	SP62	0,25
	62	24	1,1	20,6	11,3	11000		62305 2RSR		0,317
28	80	21	1,5	37,6	19	9000	11000	6405		0,575
	80	21	1,5	37,6	19	9000	11000	6405 NR	SP80	0,575
	58	16	1	10,7	6,65	14000	16000	62/28		0,173
	58	16	1	10,7	6,65	14000		62/28 2ZR		0,173
	58	16	1	10,7	6,65	14000		62/28 2RSR		0,173
	68	18	1,1	19,5	11,5	10000	12000	63/28		0,328
	68	18	1,1	19,5	11,5	10000		63/28 2ZR		0,328
	68	18	1,1	19,5	11,5	10000		63/28 RSR		0,328
	42	7	0,3	4,4	2,9	15000	18000	61806		0,027
30	42	7	0,3	4,4	2,9	15000	18000	61806 NR	SR42	0,027
	47	9	0,3	7,8	4,7	14000	17000	61906		0,045
	47	9	0,3	7,8	4,7	14000	17000	61906 NR	SR47	0,045
	55	9	3	11,2	7,35	12000	15000	16006		0,087
	55	13	1	13,2	8,25	12000	15000	6006 TN		0,129
	55	13	1	13,2	8,25	12000		6006 2ZR		0,129
	55	13	1	13,2	8,25	8000		6006 2RSR		0,129
	55	13	1	13,2	8,25	12000	15000	6006 NR	SP55	0,129
	62	16	1	19,5	11,3	10000	13000	6206		0,21
	62	16	1	19,5	11,3	10000		6206 2ZR		0,21
	62	16	1	19,5	11,3	7500		6206 2RSR		0,21
	62	16	1	19,5	11,3	10000	13000	6206 NR	SP62	0,21
	62	20	1	19,5	11,3	10000		62206 2RSR		0,236
	72	19	1,1	29,5	15,8	9000	11000	6306		0,371
	72	19	1,1	29,5	15,8	9000	11000	6306 MAP5		0,371
72	19	1,1	29,5	15,8	9000		6306 2ZR		0,371	
72	19	1,1	29,5	15,8	7000		6306 2RSR		0,371	

Single Row Deep Groove Ball Bearings

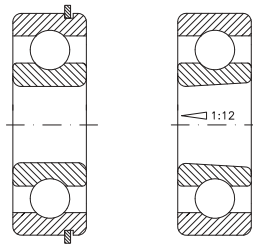

NR

K

d	Dimensions			Basical radial load		Speed limit		Designation		Mass
	D	B	r_s min	dyn. C_r	stat. C_{0r}	grease	oil	bearing	snap ring	
mm				kN		min ⁻¹		-		kg
30	72	19	1,1	29,5	15,8	9000	11000	6306 NR	SP72	0,371
	72	27	1,1	26,6	14,9	9000		62306 2RSR		0,473
	90	23	1,5	47,3	24,5	8500	10000	6406		0,785
32	90	23	1,5	47,3	24,5	8500	10000	6406 NR	SP90	0,785
	65	17	1	23	13	10000	13000	62/32		0,228
	65	17	1	23	13	10000		62/32 2ZR		0,228
	65	17	1	23	13	10000		62/32 2RSR		0,228
	75	20	1,1	30	16	9000	11000	63/32		0,437
	75	20	1,1	30	16	9000		63/32 2ZR		0,437
35	75	20	1,1	30	16	9000		63/32 2RSR		0,437
	47	7	0,3	4	3,25	13000	16000	61807		0,031
	55	10	0,6	9,5	6,2	12000	14000	61907		0,073
	62	9	0,3	12,2	8,85	10000	13000	16007		0,111
	62	14	1	15,9	10,3	10000	13000	6007		0,164
	62	14	1	15,9	10,3	10000		6007 2ZR		0,164
	62	14	1	15,9	10,3	7000		6007 2RSR		0,164
	62	14	1	15,9	10,3	10000	13000	6007 NR	SP62	0,164
	72	17	1,1	25,7	15,6	9000	11000	6207 K		0,315
	72	17	1,1	25,7	15,6	9000	11000	6207 TN		0,315
	72	17	1,1	25,7	15,6	9000	11000	6207 MAP6		0,315
	72	17	1,1	25,7	15,6	9000	11000	6207 P6		0,315
	72	17	1,1	25,7	15,6	9000	11000	6207 P5		0,315
	72	17	1,1	25,7	15,6	9000		6207 2ZR		0,315
	72	17	1,1	25,7	15,6	6000		6207 2RSR		0,315
	72	17	1,1	25,7	15,6	9000	11000	6207 NR	SP72	0,315
	72	17	1,1	25,7	15,6	9000	11000	6207 NRP6	SP72	0,315
	72	17	1,1	25,7	15,6	9000	11000	6207 MA		0,315
	72	23	1,1	25,7	15,6	9000		62207 2RSR		0,375
	80	21	1,5	33,5	19,2	8500	10000	6307		0,45
	80	21	1,5	33,5	19,2	8500	10000	6307 K		0,45
80	21	1,5	33,5	19,2	8500	10000	6307 P6		0,45	
80	21	1,5	33,5	19,2	8500	10000	6307 P5		0,45	
80	21	1,5	33,5	19,2	8500		6307 2ZR		0,45	
80	21	1,5	33,5	19,2	8500		6307 2ZRP5		0,45	
80	21	1,5	33,5	19,2	6500		6307 2RSR		0,45	

Single Row Deep Groove Ball Bearings

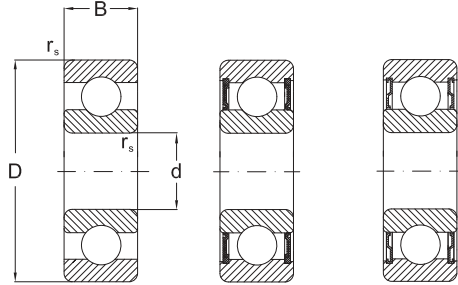

2RSR

2ZR

Dimensions				Basical radial load		Speed limit		Designation		Mass
d	D	B	r _s min	dyn. C _r	stat. C _{0r}	grease	oil	bearing	snap ring	
mm				kN		min ⁻¹		-		kg
35	80	21	1,5	33,5	19,2	6500		6307 2RSRP6		0,45
	80	21	1,5	33,5	19,2	6500		6307 2RSRP5		0,45
	80	31	1,5	33,5	19,2	8500	10000	6307 NR	SP80	0,45
	80	31	1,5	33,5	19,2	8500		62307 2RSR		0,658
	100	25	1,5	55,5	29,4	7000	8500	6407		0,954
	100	25	1,5	55,5	29,4	7000	8500	6407 NR	SP100	0,954
40	52	7	0,3	4,5	4,05	11000	14000	61808 P5		0,034
	52	7	0,3	4,5	4,05	11000	14000	61808 NR	SR52	0,034
	62	12	0,6	14,5	10,2	11000	13000	61908		0,11
	62	12	0,6	14,5	10,2	11000	13000	61908 NR	SR62	0,11
	68	9	0,3	13,3	9,8	9500	12000	16008		0,13
	68	15	1	16,8	11,6	9500	12000	6008		0,21
	68	15	1	16,8	11,6	9500		6008 2ZR		0,21
	68	15	1	16,8	11,6	6000		6008 2RSR		0,21
	68	15	1	16,8	11,6	9500	12000	6008 NR	SP68	0,21
	80	18	1,1	32,6	20	8500	10000	6208		0,402
	80	18	1,1	32,6	20	8500	10000	6208 K		0,402
	80	18	1,1	32,6	20	8500	10000	6208 P6		0,402
	80	18	1,1	32,6	20	8500	10000	6208 P5		0,402
	80	18	1,1	32,6	20	8500		6208 2ZR		0,402
	80	18	1,1	32,6	20	5600		6208 2ZRP5		0,402
	80	18	1,1	32,6	20	5600		6208 2RSRP5		0,402
	80	18	1,1	32,6	20	8500	10000	6208 NR	SP80	0,402
	80	18	1,1	32,6	20	8500	10000	6208 MB		0,402
	80	18	1,1	32,6	20	8500	10000	6208 NMA		0,402
	80	23	1,1	32,6	20	8500		62208 2RSR		0,46
	90	23	1,5	40,8	24	7500	9000	6308		0,635
	90	23	1,5	40,8	24	7500	9000	6308 K		0,635
	90	23	1,5	40,8	24	7500	9000	6308 TN		0,635
	90	23	1,5	40,8	24	7500	9000	6308 P6		0,635
	90	23	1,5	40,8	24	7500	9000	6308 P5		0,635
	90	23	1,5	40,8	24	7500		6308 2ZR		0,635
90	23	1,5	40,8	24	7500		6308 2ZRP5		0,635	
90	23	1,5	40,8	24	5500		6308 2RSR		0,635	

Single Row Deep Groove Ball Bearings

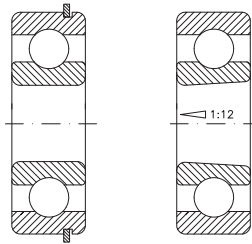

NR

K

d	Dimensions			Basical radial load		Speed limit		Designation		Mass
	D	B	r_s min	dyn. C_r	stat. C_{0r}	grease	oil	bearing	snap ring	
mm				kN		min ⁻¹		-		kg
40	90	23	1,5	40,8	24	7500	9000	6308 NMA		0,635
	90	23	1,5	40,8	24	7500	9000	6308 NR	SP90	0,635
	90	33	1,5	40,8	24	7500		62308 2RSR		0,874
	110	27	2	64	35	6700	7500	6408		1,23
	110	27	2	64	35	6700	7500	6408 NR	SP110	1,23
45	58	7	0,3	6,4	5,6	9500	12000	61809		0,043
	68	12	0,6	14	9,8	9700	12000	61909		0,12
	75	10	0,6	15,5	12,3	9000	11000	16009		0,17
	75	16	1	21	15	9000	11000	6009		0,261
	75	16	1	21	15	9000	11000	6009 P5		0,261
	75	16	1	21	15	9000	11000	6009 P4		0,261
	75	16	1	21	15	9000		6009 2ZR		0,261
	75	16	1	21	15	9000		6009 2ZRP4		0,261
	75	16	1	21	15	5600		6009 2RSR		0,261
	75	16	1	21	15	9000	11000	6009 NR	SP75	0,261
	85	19	1,1	32,7	20,6	7500	9000	6209		0,414
	85	19	1,1	32,7	20,6	7500	9000	6209 K		0,414
	85	19	1,1	32,7	20,6	7500	9000	6209 P6		0,414
	85	19	1,1	32,7	20,6	7500	9000	6209 P5		0,414
	85	19	1,1	32,7	20,6	7500		6209 2ZR		0,414
	85	19	1,1	32,7	20,6	5000		6209 2ZRP5		0,414
	85	19	1,1	32,7	20,6	5000		6209 2RSRP6		0,414
	85	19	1,1	32,7	20,6	5000		6209 2RSRP5		0,414
	85	19	1,1	32,7	20,6	7500	9000	6209 NR	SP85	0,414
	85	23	1,1	32,7	20,6	5600		62209 2RSR		0,481
	100	25	1,5	52,8	31,7	6700	8000	6309		0,838
	100	25	1,5	52,8	31,7	6700	8000	6309 K		0,838
	100	25	1,5	52,8	31,7	6700	8000	6309 MB		0,838
	100	25	1,5	52,8	31,7	6700	8000	6309 MAP6		0,838
	100	25	1,5	52,8	31,7	6700	8000	6309 P6		0,838
	100	25	1,5	52,8	31,7	6700	8000	6309 P5		0,838
100	25	1,5	52,8	31,7	6700		6309 2ZR		0,838	
100	25	1,5	52,8	31,7	6700		6309 2ZRP5		0,838	
100	25	1,5	52,8	31,7	4500		6309 2RSR		0,838	

Single Row Deep Groove Ball Bearings

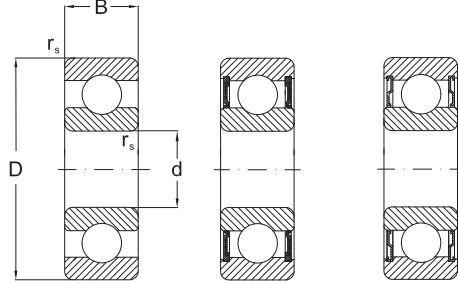

2RSR

2ZR

Dimensions				Basical radial load		Speed limit		Designation		Mass
d	D	B	r _s min	dyn. C _r	stat. C _{0r}	grease	oil	bearing	snap ring	
mm				kN		min ⁻¹		-		kg
45	100	25	1,5	52,8	31,7	4500		6309 2RSRP6		0,838
	100	25	1,5	52,8	31,7	4500		6309 2RSRP5		0,838
	100	25	1,5	52,8	31,7	6700	8000	6309 NR	SP100	0,838
	100	36	1,5	52,8	31,7	4500		62309 2RSR		1,18
	120	29	2	76,8	44,9	5600	6700	6409		1,54
	120	29	2	76,8	44,9	5600	6700	6409 NR	SP120	1,54
50	65	7	0,3	6,8	6,3	9000	11000	61810		0,057
	65	7	0,3	6,8	6,3	9000	11000	61810 NR	SR65	0,057
	72	12	0,6	14,5	10,4	9000	11000	61910		0,13
	72	12	0,6	14,5	10,4	9000	11000	61910 NR	SR72	0,13
	80	10	0,6	16,3	13,1	8500	10000	16010		0,188
	80	16	1	21,8	16,6	8500	10000	6010 K		0,26
	80	16	1	21,8	16,6	8500		6010 2ZR		0,26
	80	16	1	21,8	16,6	5300		6010 2RSR		0,26
	80	16	1	21,8	16,6	8500	10000	6010 NR	SP80	0,26
	90	20	1,1	35,1	23,2	7000	8500	6210		0,46
	90	20	1,1	35,1	23,2	7000	8500	6210 K		0,46
	90	20	1,1	35,1	23,2	7000	8500	6210 M		0,46
	90	20	1,1	35,1	23,2	7000	8500	6210 MAP6		0,46
	90	20	1,1	35,1	23,2	7000	8500	6210 P6		0,46
	90	20	1,1	35,1	23,2	7000	8500	6210 P5		0,46
	90	20	1,1	35,1	23,2	7000		6210 2ZR		0,46
	90	20	1,1	35,1	23,2	7000		6210 2ZRP5		0,46
	90	20	1,1	35,1	23,2	4500		6210 2RSR		0,46
	90	20	1,1	35,1	23,2	4500		6210 2RSRP6		0,46
	90	20	1,1	35,1	23,2	4500		6210 2RSRP5		0,46
	90	20	1,1	35,1	23,2	7000	8500	6210 NR	SP90	0,46
	90	23	1,1	35,1	23,2	7000		62210 2RSR		0,514
	110	27	2	61,8	37,9	6300	7000	6310		1,06
	110	27	2	61,8	37,9	6300	7000	6310 K		1,06
110	27	2	61,8	37,9	6300	7000	6310 MAP6		1,06	
110	27	2	61,8	37,9	6300		6310 2ZR		1,06	
110	27	2	61,8	37,9	4000		6310 2RSR		1,06	
110	27	2	61,8	37,9	6300	7000	6310 NR	SP110	1,06	
110	40	2	61,8	37,9	4000		62310 2RSR		1,65	

Single Row Deep Groove Ball Bearings

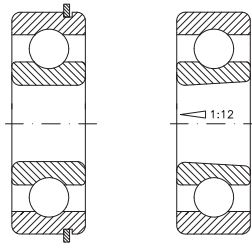

NR

K

d	Dimensions			Basical radial load		Speed limit		Designation		Mass
	D	B	r_s min	dyn. C_r	stat. C_{0r}	grease	oil	bearing	snap ring	
mm				kN		min ⁻¹		-		kg
50	130	31	2,1	87,1	52	5000	6000	6410		1,89
	130	31	2,1	87,1	52	5000	6000	6410 NR	SP130	1,89
55	72	9	0,3	9	8,5	8500	10000	61811		0,083
	90	11	0,6	19,3	16,3	7500	9000	16011		0,26
	90	18	1,1	28,3	21,3	7500	9000	6011 MB		0,39
	90	18	1,1	28,3	21,3	7500		6011 2ZR		0,39
	90	18	1,1	28,3	21,3	4500		6011 2RSR		0,39
	90	18	1,1	28,3	21,3	7500	9000	6011 NR	SP90	0,39
	100	21	1,5	43,4	29,4	6300	7500	6211		0,611
	100	21	1,5	43,4	29,4	6300	7500	6211 K		0,611
	100	21	1,5	43,4	29,4	6300	7500	6211 MA		0,611
	100	21	1,5	43,4	29,4	6300		6211 2ZR		0,611
	100	21	1,5	43,4	29,4	4000		6211 2RSR		0,611
	100	21	1,5	43,4	29,4	6300	7500	6211 NR	SP100	0,611
	100	25	1,5	43,4	29,4	4000		62211 2RSR		0,7
	120	29	2	71,7	45	5300	6300	6311		1,38
	120	29	2	71,7	45	5300	6300	6311 K		1,38
	120	29	2	71,7	45	5300	6300	6311 MA		1,38
	120	29	2	71,7	45	5300		6311 2ZR		1,38
	120	29	2	71,7	45	3600		6311 2RSR		1,38
120	29	2	71,7	45	5300	6300	6311 NR	SP120	1,38	
120	43	2	71,7	45	3600		62311 2RSR		2,04	
140	33	2,1	100	62	4800	5600	6411		2,3	
140	33	2,1	100	62	4800	5600	6411 NR	SP140	2,3	
60	78	10	0,3	8,7	6,7	8000	9500	61812		0,12
	95	11	0,6	20	17,6	7000	8500	16012		0,28
	95	18	1,1	29,4	23,3	7000	8000	6012		0,42
	95	18	1,1	29,4	23,3	6700		6012 2ZR		0,42
	95	18	1,1	29,4	23,3	4300		6012 2RSR		0,42
	95	18	1,1	29,4	23,3	7000	8000	6012 NR	SP95	0,42
	110	22	1,5	52,4	36,3	6000	7000	6212		0,78
	110	22	1,5	52,4	36,3	6000	7000	6212 K		0,78
	110	22	1,5	52,4	36,3	6000		6212 MA		0,78
	110	22	1,5	52,4	36,3	6000		6212 2ZR		0,78
110	22	1,5	52,4	36,3	3800		6212 2RSR		0,78	

Single Row Deep Groove Ball Bearings

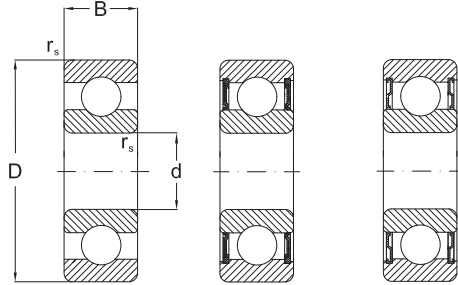

2RSR

2ZR

Dimensions				Basical radial load		Speed limit		Designation		Mass
d	D	B	r _s min	dyn. C _r	stat. C _{0r}	grease	oil	bearing	snap ring	
mm				kN		min ⁻¹		-		kg
60	110	22	1,5	52,4	36,3	6000	7000	6212 NR	SP110	0,78
	110	28	1,5	52,4	36,3	6000	7000	62212		0,97
	130	31	2,1	81,9	52,2	5000	6000	6312		1,72
	130	31	2,1	81,9	52,2	5000	6000	6312 K		1,72
	130	31	2,1	81,9	52,2	5000		6312 2ZR		1,72
	130	31	2,1	81,9	52,2	3400		6312 2RSR		1,72
	130	31	2,1	81,9	52,2	5000	6000	6312 NR	SP130	1,72
	130	46	2,1	81,9	52,2	3400		62312 2RSR		2,55
	150	35	2,1	110	70,8	4300	5000	6412		2,76
	150	35	2,1	110	70,8	4300	5000	6412 NR	SP150	2,76
62	110	22	1,5	47,5	28	6000	7000	62/62		0,6
65	85	10	0,6	12,2	12	7000	8500	61813		0,13
	100	11	0,6	22,9	19,6	6300	7500	16013		0,3
	100	18	1,1	30,5	25,4	6300	7500	6013 K		0,44
	100	18	1,1	30,5	25,4	6300		6013 2ZR		0,44
	100	18	1,1	30,5	25,4	4000		6013 2RSR		0,44
	100	18	1,1	30,5	25,4	6300	7500	6013 NR	SP100	0,44
	120	23	1,5	57,2	40	5300	6300	6213		0,995
	120	23	1,5	57,2	40	5300	6300	6213 M		0,995
	120	23	1,5	57,2	40	5300	6300	6213 MA		0,995
	120	23	1,5	57,2	40	3600		6213 2ZR		0,995
	120	23	1,5	57,2	40	5300	6300	6213 NR	SP120	0,995
	140	33	2,1	92,7	59,7	4800	5600	6313		2,1
	140	33	2,1	92,7	59,7	4800	5600	6313 MA		2,1
	140	33	2,1	92,7	59,7	4800	5600	6313 MB		2,1
	140	33	2,1	92,7	59,7	4800		6313 2ZR		2,1
	140	33	2,1	92,7	59,7	3000		6313 2RSR		2,1
	140	33	2,1	92,7	59,7	4800	5600	6313 NR	SP140	2,1
	160	37	2,1	118	79	4000	4800	6413		3,3
	160	37	2,1	118	79	4000	4800	6413 NR	SP160	3,3
	70	90	10	0,6	12,5	10	6700	8000	61814	
110		13	0,6	27,9	25	6000	7000	16014		0,433
110		20	1,1	38,1	30,9	6000	7000	6014		0,6
110		20	1,1	38,1	30,9	6000	7000	6014 MAP5		0,6

Single Row Deep Groove Ball Bearings

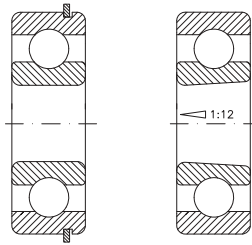

NR

K

d	Dimensions			Basical radial load		Speed limit		Designation		Mass
	D	B	r_s min	dyn. C_r	stat. C_{0r}	grease	oil	bearing	snap ring	
mm				kN		min ⁻¹		-		kg
70	110	20	1,1	38,1	30,9	6000		6014 2ZR		0,6
	110	20	1,1	38,1	30,9	3800		6014 2RSR		0,6
	110	20	1,1	38,1	30,9	6000	7000	6014 NR	SP110	0,6
	125	24	1,5	62,2	44,1	5000	6000	6214		1,07
	125	24	1,5	62,2	44,1	5000	6000	6214 MA		1,07
	125	24	1,5	62,2	44,1	5000		6214 2ZR		1,07
	125	24	1,5	62,2	44	3400		6214 2RSR		1,07
	125	24	1,5	62,2	44	5000	6000	6214 NR	SP125	1,07
	125	31	1,5	62,2	44	3400		62214 2RSR		1,36
	150	35	2,1	104	68,1	4500	5300	6314		2,5
	150	35	2,1	104	68,1	4500	5300	6314 K		2,5
	150	35	2,1	104	68,1	4500	5300	6314 MAP6		2,5
	150	35	2,1	104	68,1	4500		6314 2ZR		2,5
	150	35	2,1	104	68,1	2900		6314 2RSR		2,5
150	35	2,1	104	68,1	4500	5300	6314 NR	SP150	2,5	
150	51	2,1	104	68,1	2900		62314 2RSR		3,55	
180	42	3	144	104	3800	4500	6414		4,85	
75	95	10	0,6	12,8	12,1	6300	7500	61815 P5		0,16
	95	10	0,6	12,8	12,1	4000		61815 2RSR		0,16
	115	13	0,6	28,5	26,8	5600	6700	6015		0,46
	115	20	1,1	39,7	33,5	5600	6700	6015 M		0,64
	115	20	1,1	39,7	33,5	5600	6700	6015 MAP5		0,64
	115	20	1,1	39,7	33,5	5600		6015 2ZR		0,64
	115	20	1,1	39,7	33,5	3600		6015 2RSR		0,64
	115	20	1,1	39,7	33,5	5600	6700	6015 NR	SP115	0,64
	130	25	1,5	67,4	49,3	4800	5600	6215		1,18
	130	25	1,5	67,4	49,3	4800	5600	6215 K		1,18
	130	25	1,5	67,4	49,3	4800		6215 2ZR		1,18
	130	25	1,5	67,4	49,3	3200		6215 2RSR		1,18
	130	25	1,5	67,4	49,3	4800	5600	6215 NR	SP130	1,18
	160	37	2,1	113	77	4000	4800	6315		3,03
	160	37	2,1	113	77	4000	4800	6315 MP6		3,03
	160	37	2,1	113	77	4000		6315 2ZR		3,03
160	37	2,1	113	77	2800		6315 2RSR		3,03	
160	37	2,1	113	77	4000	4800	6315 NR	SP160	3,03	

Single Row Deep Groove Ball Bearings

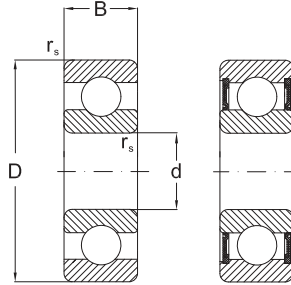

2RSR

d	Dimensions			Basical radial load		Speed limit		Designation		Mass
	D	B	r_s min	dyn. C_r	stat. C_{0r}	grease	oil	bearing	snap ring	
mm				kN		min ⁻¹		-		kg
75	190	45	3	154	115	3600	4300	6415		6,5
	100	10	0,6	12,9	13,7	6000	7000	61816		0,16
	110	16	1	25,1	20,5	5600	6700	61916		0,38
	125	14	0,6	31,9	29,7	5300	6300	16016		0,6
	125	22	1,1	47,6	39,8	5300	6300	6016 MA		0,85
	125	22	1,1	47,6	39,8	5300		6016 2ZR		0,85
	125	22	1,1	47,6	39,8	3400		6016 2RSR		0,85
	125	22	1,1	47,6	39,8	5300	6300	6016 NR	SP125	0,85
	140	26	2	72,7	53	4500	5300	6216		1,4
	140	26	2	72,7	53	4500	5300	6216 K		1,4
	140	26	2	72,7	53	4500	5300	6216 MA		1,4
	140	26	2	72,7	53	4500		6216 2ZR		1,4
	140	26	2	72,7	53	3000		6216 2RSR		1,4
	140	26	2	72,7	53	4500	5300	6216 NR	SP140	1,4
	140	33	2	72,7	53	3000		62216 2RSR		1,7
	170	39	2,1	123	86,5	3800	4500	6316 K		3,6
	170	39	2,1	123	86,5	3800	4500	6316 M		3,6
170	39	2,1	123	86,5	3800		6316 2ZR		3,6	
170	58	2,1	123	86,5	2500		62316 2RSR		4,2	
170	39	2,1	123	86,5	3800	4500	6316 NR	SP170	3,6	
200	48	3	164	125	3400	4000	6416		7,5	
85	110	13	1	19,3	20	5300	6300	61817		0,29
	130	14	1	33,8	33,5	5000	6000	16017		0,63
	130	22	1,1	49,5	43,1	5000	6000	6017		0,89
	130	22	1,1	49,5	43,1	5000		6017 2ZR		0,89
	130	22	1,1	49,5	43,1	3200		6017 2RSR		0,89
	130	22	1,1	49,5	43,1	5000	6000	6017 NR	SP130	0,89
	150	28	2	84	61,9	4300	5000	6217		1,8
	150	28	2	84	61,9	4300	5000	6217 K		1,8
	150	28	2	84	61,9	4300	5000	6217 MP6		1,8
	150	28	2	84	61,9	4300		6217 2ZR		1,8
	150	28	2	84	61,9	2800		6217 2RSR		1,8
	150	28	2	84	61,9	4300	5000	6217 NR	SP150	1,8
	150	36	2	84	61,9	2800		62217 2RSR		2,1
	180	41	3	133	96,9	3600	4300	6317		4,2

Single Row Deep Groove Ball Bearings

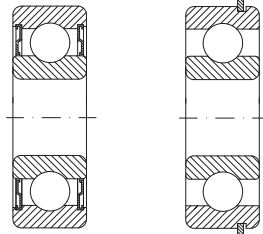

2ZR

NR

d	Dimensions			Basical radial load		Speed limit		Designation		Mass
	D	B	r_s min	dyn. C_r	stat. C_{0r}	grease	oil	bearing	snap ring	
mm				kN		min ⁻¹		-		kg
85	180	41	3	133	96,9	3600	4300	6317 K		4,2
	180	41	3	133	96,9	3600	4300	6317 MA		4,2
	180	41	3	133	96,9	3600	4300	6317 MB		4,2
	180	41	3	133	96,9	3600		6317 ZZR		4,2
	180	41	3	133	96,9	3600	4300	6317 NR	SP180	4,2
	180	60	3	133	96,9	2300		62317 2RSR		4,8
	210	52	4	173	136	3200	3800	6417		9
90	115	13	1	19,6	20,4	5300	6300	61818		0,3
	140	16	1	41,9	40,4	4500	5300	16018		0,85
	140	24	1,5	58,2	49,7	4500	5300	6018 MA		1,16
	140	24	1,5	58,2	49,7	4500	5300	6018 MP6		1,16
	140	24	1,5	58,2	49,7	4500		6018 2ZR		1,16
	140	24	1,5	58,2	49,7	3000		6018 2RSR		1,16
	140	24	1,5	58,2	49,7	4500	5300	6018 NR	SP140	1,6
	160	30	2	96	71,5	3800	4500	6218		2,16
	160	30	2	96	71,5	3800	4500	6218 K		2,16
	160	30	2	96	71,5	3800	4500	6218 MA		2,16
	160	30	2	96	71,5	3800	4500	6218 MP6		2,16
	160	30	2	96	71,5	2600		6218 2RSR		2,16
	160	30	2	96	71,5	3800		6218 2ZR		2,16
	160	30	2	96	71,5	3800	4500	6218 NR	SP160	2,16
	160	40	2	96	71,5	2600		62218 2RSR		2,4
	190	43	3	143	107	3400	4000	6318		4,9
	190	43	3	143	107	3400	4000	6318 K		4,9
	190	43	3	143	107	3400	4000	6318 M		4,9
	190	43	3	143	107	3400		6318 2ZR		4,9
	190	43	3	143	107	3400	4000	6318 NR	SP190	4,9
190	64	3	143	107	2100		62318 2RSR		5,5	
225	54	4	190	160	3000	3600	6418		11,5	
145	16	1	42,3	41,5	4300	5000	16019		0,89	
145	24	1,5	60,5	53,6	4300	5000	6019		1,2	
95	145	24	1,5	60,5	53,6	4300		6019 2ZR		1,2
	145	24	1,5	60,5	53,6	2900		6019 2RSR		1,2
	145	24	1,5	60,5	53,6	4300	5000	6019 NR	SP145	1,2
	170	32	2,1	109	81,9	3600	4300	6219 MBP6		2,6

Single Row Deep Groove Ball Bearings

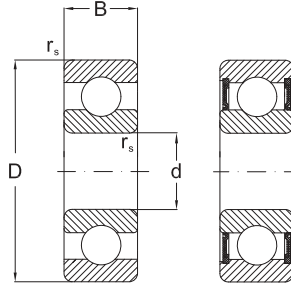

2RSR

Dimensions				Basical radial load		Speed limit		Designation		Mass
d	D	B	r_s min	dyn. C_r	stat. C_{0r}	grease	oil	bearing	snap ring	
mm				kN		min ⁻¹		-		kg
95	170	32	2.1	109	81.9	2400		6219 2RSR		2.6
	170	32	2.1	109	81.9	3600		6219 2ZR		2.6
	170	32	2.1	109	81.9	3600	4300	6219 NR	SP170	2.6
	170	43	2.1	109	81.9	2400		62219 2RSR		2.8
	200	45	3	153	118	3200	3800	6319		5.6
	200	45	3	153	118	3200	3800	6319 MAP6		5.6
	200	67	3	153	118	2000		62319 2RSR		6.5
100	125	13	1	19,6	21,2	4800	5600	61820 MAP5		0,32
	150	16	1	45	44	4300	5000	16020		0,91
	150	24	1,5	60,5	54	4300	5000	6020 MAP6		1,25
	150	24	1,5	60,5	54	4300		6020 2ZR		1,25
	150	24	1,5	60,5	54	2800		6020 2RSR		1,25
	150	24	1,5	60,5	54	4300	5000	6020 NR	SP150	1,25
	180	34	2,1	124	93	3400	4000	6220		3,1
	180	34	2,1	124	93	2200		6220 2RSR		3,1
	180	34	2,1	124	93	3400		6220 2ZR		3,1
	180	34	2,1	124	93	3400	4000	6220 MA		3,15
	180	34	2,1	124	93	3400	4000	6220 MP6		3,15
	180	34	2,1	124	93	3400	4000	6220 NR	SP180	3,15
105	180	46	2,1	124	93	2200		62220 2RSR		?
	215	47	3	173	140	3000		6320 2ZR		7
	215	47	3	173	140	3000	3600	6320 MAP6		7
	130	13	1	20,8	19	4500	5300	61821 MAP5		0,35
	160	18	1	52	51	4000	4800	16021		1,2
	160	26	2	72,3	65,8	3800	4500	6021 M		1,6
	160	26	2	72,3	65,8	2400		6021 2RSR		1,6
	160	26	2	72,3	65,8	3800		6021 2ZR		1,6
	160	26	2	72,3	65,8	3800	4500	6021 NR	SP160	1,6
	190	36	2,1	133	104	3200	3800	6221		3,7
110	190	36	2,1	133	104	2100		6221 2RSR		3,7
	190	36	2,1	133	104	3200		6221 2ZR		3,7
	190	36	2,1	133	104	3200	3800	6221 MA		3,7
	225	49	3	184	153	2800	3400	6321 MA		8
	140	16	1	28,1	29	4300	5000	61822		0,6
	170	19	1	57,5	56,7	3800	4500	16022		1,46

Single Row Deep Groove Ball Bearings

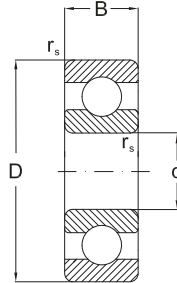

Dimensions				Basical radial load		Speed limit		Designation		Mass
d	D	B	r _s min	dyn. C _r	stat. C _{0r}	grease	oil	bearing	snap ring	
mm				kN		min ⁻¹		-		kg
110	170	28	2	82	73	3600	4300	6022		1,95
	170	28	2	82	73	2300		6022 2RSR		1,95
	170	28	2	82	73	3600		6022 2ZR		1,95
	170	28	2	82	73	3600	4300	6022 NR	SP170	1,95
	200	38	2,1	143	118	3000	3600	6222		4,35
	200	38	2,1	143	118	1900		6222 2RSR		4,35
	200	38	2,1	143	118	3000		6222 2ZR		4,35
	200	38	2,1	143	118	3000	3600	6222 M		4,35
	200	38	2,1	143	118	3000	3600	6222 NR	SP200	4,35
120	240	50	3	203	178	2600	3200	6322		9,58
	240	50	3	203	178	2600	3200	6322 MA		9,58
	150	16	1	29,1	32,5	3800	4500	61824		0,65
	180	19	1	63,2	63,3	3400	4000	16024		1,7
	180	28	2	85	79,3	3400	4000	6024 MP6		2,09
	180	28	2	85	79,3	2100		6024 2RSR		2,09
	180	28	2	85	79,3	3400		6024 2ZR		2,09
	180	28	2	85	79,3	3400	4000	6024 NR	SP180	2,09
	215	40	2,1	155	131	2800	3400	6224		5,15
130	215	40	2,1	155	131	2800	3400	6224 MB		5,15
	215	40	2,1	155	131	2800	3400	6224 MAP6		5,15
	215	40	2,1	155	131	2800		6224 2ZR		5,15
	215	40	2,1	155	131	2800	3400	6224 NR	SP215	5,15
	260	55	3	212	190	2400	3000	6324 MA		13,6
	165	18	1,1	38	43	3600	4300	61826 MAP5		0,93
	200	22	1,1	79	81	3200	3800	16026		2,5
	200	33	2	106	101	3000	3600	6026		3,25
	200	33	2	106	101	1900		6026 2RSR		3,25
140	200	33	2	106	101	3000		6026 2ZR		3,25
	200	33	2	106	101	3000	3600	6026 NR	SP200	3,25
	230	40	3	167	146	2600	3200	6226		6
	230	40	3	167	146	2600	3200	6226 M		6
	280	58	4	229	214	2200	2800	6326 MA		17
	175	18	1,1	39	46	3400	4000	61828 MAP5		1
	210	22	1,1	80,5	86	2800	3400	16028		2,7
	210	33	2	110	109	2800	3400	6028 MP6		3,35

Single Row Deep Groove Ball Bearings

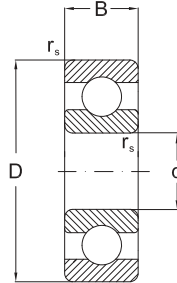

Dimensions				Basical radial load		Speed limit		Designation		Mass
d	D	B	r_s min	dyn. C_r	stat. C_{0r}	grease	oil	bearing	snap ring	
mm				kN		min ⁻¹		-		kg
140	250	42	3	176	164	2400	3000	6228		7,5
	250	42	3	176	164	2400	3000	6228 MA		7,5
	300	62	4	253	246	2000	2600	6328 MA		21
150	190	20	1,1	48,8	61	3000	3600	61830		1,4
	225	24	1,1	92,3	98	2600	3200	16030		3,4
	225	35	2,1	125	126	2600	3200	6030 MA		4,75
	270	45	3	176	170	2000	2600	6230 MA		9,6
	320	65	4	275	284	1900	2400	6330 MA		25
160	200	20	1,1	52	62	2800	3400	61832		1,49
	240	25	1,5	99,4	107	2400	3000	16032		3,6
	240	38	2,1	140	143	2400	3000	6032 MA		5,85
	290	48	3	185	186	1900	2400	6232 MA		15
170	215	22	1,1	61,8	73,5	2600	3200	61834 P6		2
	260	28	1,5	118	127	2200	2800	16034		5,7
	260	42	2,1	168	172	2200	2800	6034 MA		7,8
	310	52	4	212	224	1900	2400	6234 MA		17,5
180	225	22	1,1	62,3	78,5	2400	3000	61836 P5		2
	250	33	2	128	137	2200	2800	61936 MA		4,9
	280	31	2	140	146	2000	2600	16036 MA		7
	280	46	2,1	186	194	2000	2600	6036		10,5
	320	52	4	227	242	1800	2200	6236		18,5
190	240	24	1,5	74,1	92	2200	2800	61838		2,6
	290	31	2	148	162	2000	2600	16038		7,9
	290	46	2,1	194	210	2000	2600	6038 MA		11
	290	46	2,1	194	210	2000	2600	6038 MB		11
	290	46	2,1	194	210	2000	2600	6038 MBP6		11
	290	46	2,1	194	210	2000	2600	6038 MBP5		11
	340	55	4	255	278	1700	2000	6238 MA		23
	340	55	4	255	278	1700	2000	6238 MB		23
200	250	24	1,5	78	93	2200	2800	61840 MB		2,7
	280	38	2,1	151	160	2200	2800	61940 MB		7,25
	310	34	2	168	187	1900	2400	16040 MBP6		9
	310	34	2	168	187	1900	2400	16040 MBP5		9
	310	51	2,1	208	226	1900	2400	6040 MA		13,5
	310	51	2,1	208	226	1900	2400	6040 MB		13,5

Single Row Deep Groove Ball Bearings

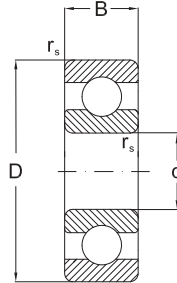

Dimensions				Basical radial load		Speed limit		Designation		Mass
d	D	B	r _s min	dyn. C _r	stat. C _{0r}	grease	oil	bearing	snap ring	
mm				kN		min ⁻¹		-		kg
200	310	51	2,1	208	226	1900	2400	6040 MBP52		13,5
	360	58	4	280	314	1700	2000	6240 M		28
	360	58	4	280	314	1700	2000	6240 MB		27
220	270	24	1,5	78	110	1900	2400	61844 M		3
	300	38	2,1	151	180	1900	2400	61944 M		8
	340	37	2,1	174	204	1800	2200	16044 M		12
	340	56	3	245	290	1700	2000	6044 M		18
	400	65	4	290	354	1500	1800	6244 M		36,9
	460	88	5	410	520	1300	1600	6344 M		74,5
240	300	28	2	108	150	1800	2200	61848 M		4,5
	320	38	2,1	159	200	1800	2200	61948 M		8,6
	360	37	2,1	185	228	1600	1900	16048		14,3
	360	56	3	255	315	1600	1900	6048 M		19,9
	440	72	4	358	475	1400	1700	6248 M		50,2
	500	95	5	442	585	1100	1400	6348 M		96
260	320	28	2	96	125	1700	2000	61852 M		4,8
	360	46	2,1	212	270	1600	1900	61952 M		14,5
	400	44	3	238	310	1500	1800	16052 M		21,2
	400	65	4	300	390	1400	1700	6052 MA		31,1
	480	80	5	390	530	1100	1400	6252 M		66,6
	540	102	6	507	710	1000	1300	6352 M		119
280	350	33	2	125	170	1600	1900	61856 MA		7,4
	380	46	2,1	216	285	1500	1800	61956 M		15,5
	420	44	3	240	325	1400	1700	16056		23,1
	420	65	4	305	425	1400	1700	6056 M		33
	500	80	5	423	600	1100	1400	6256 M		70,5
	580	108	6	572	850	950	1200	6356 M		146
300	380	38	2,1	150	195	1400	1700	61860 M		10,5
	420	56	3	270	375	1300	1600	61960 M		24,5
	460	50	4	295	415	1300	1600	16060 M		32,7
	460	74	4	360	510	1200	1500	6060 M		43,2
320	400	38	2,1	172	255	1300	1600	61864 M		11
	440	56	3	276	400	1200	1500	61964 M		25,5
	480	50	4	305	446	1200	1500	16064 M		34,4
	480	74	4	375	550	1200	1500	6064 M		49,4

Single Row Deep Groove Ball Bearings

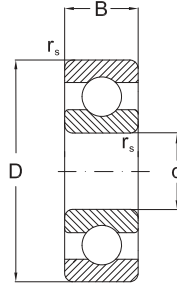

Dimensions				Basical radial load		Speed limit		Designation		Mass
d	D	B	r_s min	dyn. C_r	stat. C_{0r}	grease	oil	bearing	snap ring	
mm				kN		min^{-1}		-		kg
340	420	38	2,1	178	275	1200	1500	61868 M		11,5
	460	56	3	281	425	1100	1400	61968 M		26,5
	520	57	4	347	528	1100	1400	16068 MA		47,3
	520	74	5	440	658	1100	1400	6068 M		61,4
360	440	38	2,1	182	285	1100	1400	61872 MA		12
	480	56	3	291	450	1100	1400	61972 M		28
	540	57	4	351	550	1000	1300	16072 M		49,5
	540	82	5	455	735	1000	1300	6072 M		64,4
380	480	38	2,1	242	390	1000	1300	61876 M		20
	520	56	4	338	540	1000	1300	61976 M		40
	560	57	4	377	620	950	1200	16076 M		50,5
	560	82	5	450	723	1000	1300	6076 M		67,6
400	500	46	2,1	220	335	1000	1300	61880 M		20,5
	540	65	4	345	570	950	1200	61980 M		41,5
	600	90	5	523	857	900	1100	6080 M		87,2
	520	46	2,1	224	345	950	1200	61884 M		21,5
420	560	65	4	351	600	900	1100	61984 M		43
	620	90	5	507	880	900	1100	6084 M		93
	540	46	2,1	228	355	900	1100	61888 M		22,5
440	600	74	4	410	720	900	1100	61988 M		60,5
	650	94	6	553	965	850	1000	6088 M		105
	580	56	3	319	570	900	1100	61892 M		35
460	620	74	4	423	750	850	1000	61992 M		62,5
	680	100	6	580	1056	800	950	6092 M		121
	600	56	3	325	600	850	950	61896 M		36,5
	650	78	5	449	815	800	950	61996 M		74
480	700	100	6	615	1130	750	900	6096 M		126
	620	56	3	332	620	850	950	618/500 M		37,5
	670	78	5	462	865	750	900	619/500 M		77
500	720	100	6	607	1138	740	890	60/500 M		135
	650	56	3	332	655	850	950	618/530 M		39,5
	710	82	5	488	930	700	850	619/530 M		90,5
530	780	112	6	670	1290	670	800	60/530 M		186
	680	56	3	345	695	700	850	618/560 M		42
	750	85	5	494	980	670	800	619/560 M		105
	680	56	3	345	695	700	850	618/560 M		42

Single Row Deep Groove Ball Bearings

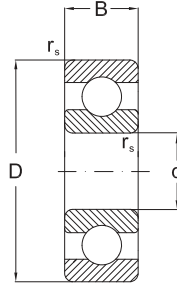

Dimensions				Basical radial load		Speed limit		Designation		Mass
d	D	B	r_s min	dyn. C_r	stat. C_{0r}	grease	oil	bearing	snap ring	
mm				kN		min ⁻¹		-		kg
560	820	115	6	720	1400	630	750	60/560 M		208
600	870	118	6	826	1753	630	750	60/600 M		236
630	920	128	7,5	819	1760	560	670	60/630 M		285
670	820	69	4	442	1000	560	670	618/670 M		77,5
	900	103	6	676	1500	530	630	619/670 M		185
	980	136	7,5	904	2040	500	600	60/670 M		345
750	920	78	5	527	1250	500	600	618/750 M		110
	1000	112	6	663	1500	500	600	619/750 M		255



Double Row Deep Groove Ball Bearings

Standards, Boundary dimensions

Standard plans	DIN 616
Deep groove ball bearing	DIN 625

General

Double Row Deep groove ball bearings feature higher load ratings when compared to single row bearings.

This two row bearing gives a very rigid arrangement, but they are very sensitive to misalignments.

Tolerances

ART Double Row Deep groove bearings are produced in normal tolerance class (**PN**) as standard.

Internal clearance

ART Double Row Deep groove ball bearings are produced with **normal internal clearance**, (**CN**) as standard. Other internal clearance groups may be produced upon request.

Design variants, Cages

ART Double Row Deep groove ball bearings have the latest design (suffix B) without filling slots.

Thus they are able to support thrust loads equally well in both directions. These bearings are fitted with **polyamide cages**, (suffix **TN**) as standard.

These bearing sizes are also available with **pressed steel cages**.

But, it must be considered that some of these bearings may have filling slots which limit the ability to support thrust loads in the direction of these filling slots.

Double Row Deep Groove Ball Bearings

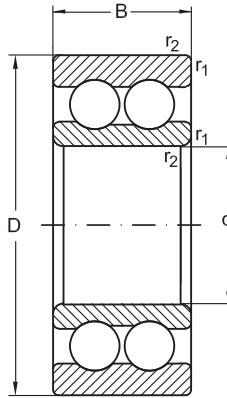

Dimensions				Basical load ratings		Speed rating		Designation	Mass
d	D	B	r_1, r_2 min.	dyn. C_r	stat. C_{0r}	grease	oil		
mm				kN		min^{-1}			kg
10	30	14	0,6	9,2	5,2	18000	22000	4200 BTN	0,049
12	32	14	0,6	10,6	6,2	17000	20000	4201 BTN	0,053
15	35	14	0,6	11,9	7,5	14000	17000	4202 BTN	0,059
	42	17	1	14,8	9,5	12000	15000	4302 BTN	0,12
17	40	16	0,6	14,8	9,5	12000	15000	4203 BTN	0,09
	47	19	1	19,5	13,5	10000	13000	4303 BTN	0,16
20	47	18	1	17,8	12,5	10000	13000	4204 BTN	0,14
	52	21	1,1	23,4	16	9500	12000	4304 BTN	0,21
25	52	18	1	19	14,5	9000	11000	4205 BTN	0,16
	62	24	1,1	31,9	22,5	8500	10000	4305 BTN	0,34
30	62	20	1	26	20,5	8000	9500	4206 BTN	0,26
	72	27	1,1	41,2	30	7000	8500	4306 BTN	0,5
35	72	23	1,1	35,1	28,5	6700	8000	4207 BTN	0,4
	80	31	1,5	50,5	38	6300	7500	4307 BTN	0,69
40	80	23	1,1	37,05	32,5	6000	7000	4208 BTN	0,5

Double Row Deep Groove Ball Bearings

Dimensions				Basical load ratings		Speed rating		Designation	Mass
d	D	B	$r_{1,2}$ min.	dyn. C_r	stat. C_{0r}	grease	oil		
mm				kN		min ⁻¹			
40	90	33	1,5	55,7	45	5600	6700	4308 BTN	0,95
45	85	23	1,1	39	36	5600	6700	4209 BTN	0,54
	100	36	1,5	68,5	56	5000	6000	4309 BTN	1,25
50	90	23	1,1	40,5	40	5000	6000	4210 BTN	0,58
	110	40	2	81,5	70	4500	5300	4310 BTN	1,7
55	100	25	1,5	45	44	4800	5600	4211 BTN	0,8
	120	43	2	97,5	83	4300	5000	4311 BTN	2,15
60	110	28	1,5	57	55	4500	5300	4212 BTN	1,1
	130	46	2,1	112	98	3800	4500	4312 BTN	2,65
65	120	31	1,5	67,5	67	4000	4800	4213 BTN	1,45
70	125	31	1,5	70	73,5	3600	4300	4214 BTN	1,5
75	130	31	1,5	72,5	80	3400	4000	4215 BTN	1,6
80	140	33	2	80,5	90	3200	3800	4216 BTN	2
85	150	36	2	93,6	102	3000	3600	4217 BTN	2,55
90	160	40	2	112	122	2800	3400	4218 BTN	3,2



Self-aligning ball bearings

Self-aligning ball bearings have a common sphered raceway in the outer ring. This feature allows angular misalignment of the shaft relative to the housing. Therefore self-aligning ball bearings are particularly used in case of bearings where misalignment can occur from errors in mounting or from shaft bending.

Double row self-aligning ball bearings are manufactured both with cylindrical bore and tapered bore (taper 1:12). Self-aligning bearings with tapered bore can be delivered, at request, with adapter sleeves.

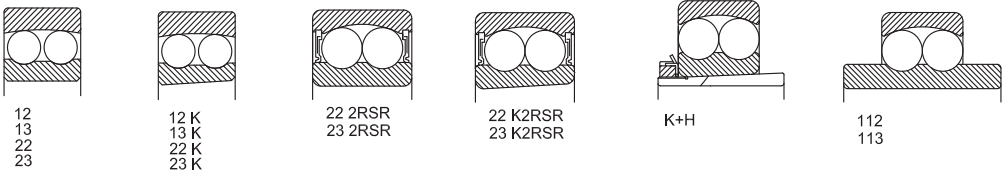

Suffixes

- C2** - radial clearance smaller than normal
- C3** - radial clearance larger than normal
- H** - adapter sleeve
- K** - tapered bore bearings
- M** - machined brass cage, ball guided
- MB** - machined brass cage, guided on the inner ring
- P6** - tolerance class more accurate than normal
- P63** - tolerance class P6 with radial clearance C3
- 2RSR** - bearing with two seals
- TN** - polyamide cage

Sealed self-aligning ball bearings

Self-aligning ball bearings are also available in a sealed version with seals at both sides. The seals are made of gasoline, oil and wear-resistant synthetic rubber. Sealed bearings are delivered filled with a certain grease quantity. Sealed bearing operating temperatures are between -30°C and $+80^{\circ}\text{C}$. Grease service life is much reduced if bearing

operates at a temperature higher than $+80^{\circ}\text{C}$ (see page 63).

Sealed bearings are greased for the entire operating period, relubrication not being necessary. Sealed bearings washing or heating before mounting in assembly is not allowed.

Self-aligning ball bearings with extended inner ring

Self-aligning ball bearings with extended inner ring of series 112 and 113 are used in applications where high accuracy is not necessary and generally, they can be mounted directly on rolled shafts. The bore manufactured to tolerance class J7 allows fast mounting and dismounting. The inner ring has a groove for bearing axial location which can be done by means of a screw or pin.

Dimensions

Overall dimensions of self-aligning ball bearings are in accordance with ISO 15.

Misalignment

Self-aligning ball bearings allow within certain limits an angular misalignment of the outer ring in relation to the inner ring, without detrimental effects in bearing unit.

Approximate values for permissible misalignment, under normal operating conditions are given in table 1.

Permissible misalignment	
Bearing series	Permissible misalignment
	degrees
108, 126, 127, 129, 135	3
12, 112	2,5
13, 113	3
22	2,5
22-2RSR	1,5
23	3
23-2RSR	1,5

Tolerances and radial clearance

Bearings of serial production are manufactured to normal tolerance class and with normal radial clearance. Tapered bore bearings of serial production are also manufactured with radial clearance C3.

Self-aligning ball bearings with extended inner ring are manufactured with radial clearance C2 and normal clearance.

At request, these bearings can also be manufactured to other tolerance classes and with smaller or larger radial clearance.

The bore of self-aligning ball bearings with extended inner ring is manufactured to tolerance class J7.

Bearing tolerances are given on page 27 and the values of radial clearance are given in tables 2 and 3.

Radial clearance of self-aligning ball bearings											
With cylindrical bore											
Bore diameter d		Designation of clearance group									
		C2		Normal		C3		C4		C5	
		Bearing radial clearance									
over	up to	min.	max.	min.	max.	min.	max.	min.	max.	min.	max.
mm		µm									
2,5	6	1	8	5	15	10	20	15	25	21	33
6	10	2	9	6	17	12	25	19	33	27	42
10	14	2	10	6	19	13	26	21	35	30	48
14	18	3	12	8	21	15	28	23	37	32	50
18	24	4	14	10	23	17	30	25	39	34	52
24	30	5	16	11	24	19	35	29	46	40	58
30	40	6	18	13	29	23	40	34	53	46	66
40	50	6	19	14	31	25	44	37	57	50	71
50	65	7	21	16	36	30	50	45	69	62	88
65	80	8	24	18	40	35	60	54	83	76	108
80	100	9	27	22	48	42	70	64	96	89	124
100	120	10	31	25	56	50	83	75	114	105	145
120	140	10	38	30	68	60	100	90	135	125	175
140	160	15	44	35	80	70	120	110	161	150	210
With tapered bore											
Table 3											
18	24	7	17	13	26	20	33	28	42	37	55
24	30	9	20	15	28	23	39	33	50	44	62
30	40	12	24	19	35	29	46	40	59	52	72
40	50	14	27	22	39	33	52	45	65	58	79
50	65	18	32	27	47	41	61	56	80	73	99
65	80	23	39	35	57	50	75	69	98	91	123
80	100	29	47	42	68	62	90	84	116	109	144
100	120	35	56	50	81	75	108	100	139	130	170
120	140	40	68	60	98	90	130	120	165	155	205
140	160	45	74	65	110	100	150	140	191	180	240

Equivalent dynamic radial load

$$P_r = F_r + Y_1 F_a, \text{ kN,} \quad \text{when } F_a/F_r \leq e,$$

$$P_r = 0,65 F_r + Y_2 F_a, \text{ kN} \quad \text{when } F_a/F_r > e,$$

The values of factors e , Y_1 and Y_2 which depend on bearings are given in bearing tables.

Equivalent static radial load

$$P_{Or} = F_r + Y_0 F_a, \text{ kN}$$

The values of the factor Y_0 which depends on bearing are given in bearing tables.

Axial load on bearings with adapter sleeves

If self-aligning ball bearings are mounted with adapter sleeves on smooth shafts, without side location, their axial carrying capacity depends on the friction between the sleeve bore and shaft.

Permissible axial load can be precisely enough determined using the equation:

$$F_{a \max} = 3 B d,$$

where:

$F_{a \max}$ - maximum permissible axial load, N

B - bearing width, mm

d - bearing bore diameter, mm

Cages

Self-aligning ball bearings are generally fitted with presses cages of sheet. At special request, when bearings operate under fluctuating loads, at high speeds and where large sizes are required, machined brass cages are recommended to be used. Glass fiber reinforced polyamide 6.6 cages are also suitable if the operating temperatures do not exceed +120°C. They have low mass, a low coefficient of friction and are noiseless while running.

Cage design and technical data are given in table 4.

Cage	Design		Application	Max. value $D_m n$	
	bearing	cage		oil	grease
Pressed sheet cage			- General application - Moderate speeds - Sealed bearings series 12, 13, 22, 23	600x10 ³	450x10 ³
Pressed sheet cage			- General application - Moderate speeds - Bearings series 22, 23	600x10 ³	450x10 ³
Polyamide cage TN			- High speeds - Bearings series 12, 13, 22, 23	1000x10 ³	800x10 ³
Machined brass cage M			- High speeds - Bearings: 1220-1222; 1317-1322; 2217-2222; 2317-2320	900x10 ³	700x10 ³

Special characteristics

In case of some dimensions of self-aligning ball bearings series 12 and 13, the balls protrude somewhat from the bearing, as shown in the adjacent design and table. This should be considered both by designer and user.

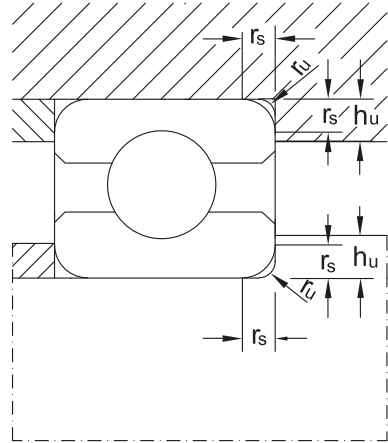
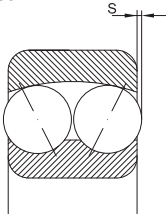

Bearing	S mm
1224	1,3
1226	0,7
1318	1
1319	1,5
1320	2,5
1321	2,6
1322	2,6

Abutment dimensions

For a proper location of bearing rings on the shaft shoulder and housing shoulder respectively, maximum connection radius $r_{u\max}$ of shaft (housing) should be less than minimum mounting chamfer $r_{s\min}$ of bearing.

Shoulder height should also be properly sized in case of bearing maximum mounting chamfer.

In case of self-aligning ball bearings with tapered bore which are mounted directly on a tapered shaft or with an adapter sleeve, proper tightening and minimum radial clearance of 10-20 μm should be assured for normal clearance and of 20-55 μm for clearance C3, depending on bearing size and series. The values of the connection radius and support shoulder height are given in table 6 and mounting dimensions for bearings mounted with adapter sleeves are given in table 7.

r_s min.	r_u max.	$h_{u\min}$ min.
		Bearing series 12, 13, 112, 22, 23, 113
mm		
0,3	0,2	1,2
0,6	0,6	2,1
1	1	2,8
1,1	1	3,5
1,5	1,5	4,5
2	2	5,5
2,1	2,1	6

Self-aligning ball bearings with adapter sleeves Abutment dimensions

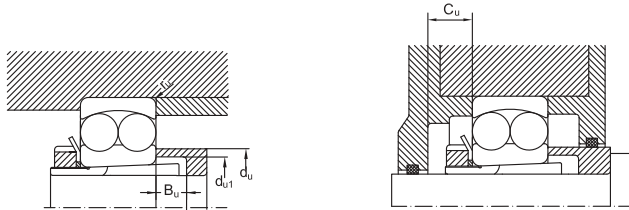
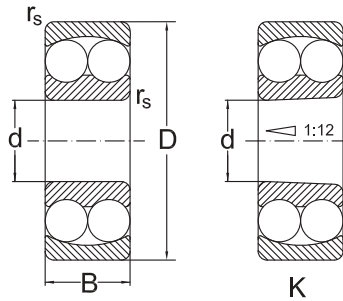

Table 7

Bore symbol	Shaft diameter	Bearing series												
		12K			22K			13K			23K			All series
		d_{u1} min.	d_u max.	B_u min.	d_{u1} min.	d_u max.	B_u min.	d_{u1} min.	d_u max.	B_u min.	d_{u1} min.	d_u max.	B_u min.	C_u min.
mm														
04	17	23	27	5	23	27	5	23	30	8	24	28	5	
05	20	28	32	6	28	32	5	28	35	6	30	34	5	15
06	25	33	38	6	33	38	5	33	42	6	35	40	5	15
07	30	38	45	5	39	44	5	39	49	7	40	45	5	17
08	35	43	52	5	44	50	5	44	55	5	45	51	5	17
09	40	48	57	5	50	56	7	50	61	5	50	57	5	17
10	45	53	62	5	55	61	9	50	61	5	56	63	5	19
11	50	60	69	6	60	68	10	60	74	6	61	69	6	19
12	55	64	75	6	65	73	9	65	83	6	66	74	6	20
13	60	70	83	6	70	79	8	70	89	6	72	82	6	21
14	60	75	86	6	75	85	11	75	94	6	77	88	6	21
15	65	80	92	6	80	90	12	80	100	6	82	94	6	23
16	70	85	99	6	85	96	12	85	107	6	88	100	6	25
17	75	90	105	7	91	102	12	91	114	7	94	106	7	27
18	80	95	110	7	96	108	10	96	120	7	100	112	7	28
19	85	100	117	7	102	114	9	102	126	7	105	117	7	29
20	90	106	124	7	108	120	8	108	132	7	110	125	7	30
21	95	111	131	7										31
22	100	116	138	7										32

Self-aligning ball bearings



Dimensions				Basic radial load. Factors						Speed limit		Designation	Mass
d	D	B	r _s min.	dyn. C _r	e	Y ₁	Y ₂	stat. C _{0r}	Y ₀	grease	oil		
mm				kN	-			kN	-	min ⁻¹		-	Kg
5	19	6	0,3	2,55	0,33	1,9	3	0,48	2	30000	36000	135	0,01
6	19	6	0,3	2,5	0,33	1,9	3	0,48	2	30000	36000	126	0,01
7	22	7	0,3	2,65	0,33	1,9	3	0,56	2	30000	36000	127	0,01
8	22	7	0,3	2,65	0,33	1,9	3	0,56	2	30000	36000	108	0,01
9	26	8	0,6	3,8	0,33	1,9	3	0,8	2	26000	32000	129	0,02
10	30	9	0,6	5,5	0,33	1,9	3	1,2	2	24000	30000	1200	0,03
	30	14	0,6	7,2	0,54	1,2	1,8	1,6	1,2	22000	28000	2200	0,04
	35	11	0,6	7,2	0,34	1,9	2,9	1,6	1,9	20000	26000	1300	0,62
12	32	10	0,6	5,6	0,37	1,7	2,6	1,25	1,8	22000	28000	1201	0,04
	32	14	0,6	7,6	0,53	1,2	1,8	1,75	1,2	20000	26000	2201	0,05
	37	12	1	9,4	0,35	1,8	2,8	2,15	1,9	18000	22000	1301	0,06
	37	17	1	9,4	0,54	1,2	1,8	2,3	1,2	17000	20000	2301	0,09
15	35	11	0,6	7,5	0,36	1,8	2,7	1,75	1,9	19000	24000	1202	0,04
	35	14	0,6	7,7	0,5	1,3	2	1,85	1,3	18000	22000	2202	0,06
	42	13	1	9,55	0,35	1,8	2,8	2,3	1,9	17000	20000	1302	0,09
	42	17	1	12,1	0,5	1,3	2	2,9	1,3	15000	18000	2302	0,11
17	40	12	0,6	7,9	0,32	1,9	3	2,05	2	18000	22000	1203	0,07
	40	16	0,6	9,8	0,5	1,3	2	2,4	1,3	17000	20000	2203	0,08
	47	14	1	12,5	0,34	1,8	2,9	3,15	2	14000	17000	1303	0,13
	47	19	1	14,5	0,49	1,3	2	3,6	1,3	13000	16000	2303	0,16
20	47	14	1	9,9	0,28	2,2	3,5	2,65	2,4	15000	18000	1204	0,12
	47	14	1	9,9	0,28	2,2	3,5	2,65	2,4	15000	18000	1204 K	0,12
	47	18	1	12,6	0,28	2,2	3,5	3,3	2,4	14000	17000	2204	0,14
	47	18	1	12,6	0,28	2,2	3,5	3,3	2,4	14000	17000	2204 K	0,14
	52	15	1,1	12,4	0,3	2,1	3,3	3,35	2,2	12000	15000	1304	0,16
	52	15	1,1	12,4	0,3	2,1	3,3	3,35	2,2	12000	15000	1304 K	0,16
	52	21	1,1	18,2	0,52	1,2	1,9	4,7	1,3	11000	14000	2304	0,21
25	52	21	1,1	18,2	0,52	1,2	1,9	4,7	1,3	11000	14000	2304 K	0,21
	52	15	1	12,2	0,29	2,2	3,4	3,3	2,3	13000	16000	1205	0,14
	52	15	1	12,2	0,29	2,2	3,4	3,3	2,3	13000	16000	1205 K	0,14
	52	15	1	12,2	0,29	2,2	3,4	3,3	2,3	13000	16000	1205 M	0,14
	52	18	1	12,5	0,43	1,5	2,3	3,45	1,6	11000	14000	2205	0,16
	52	18	1	12,5	0,43	1,5	2,3	3,45	1,6	11000	14000	2205 K	0,16
	52	18	1	12,2	0,29	2,2	3,4	3,3	2,3	7000		2205 2RSR	0,16
	52	18	1	12,2	0,29	2,2	3,4	3,3	2,3	7000		2205 K2RSR	0,16
	62	17	1,1	17,8	0,28	2,2	3,5	4,9	2,4	9500	12000	1305	0,26
	62	17	1,1	17,8	0,28	2,2	3,5	4,9	2,4	9500	12000	1305 K	0,26
62	24	1,1	24,5	0,44	1,4	2,2	6,55	1,5	9500	12000	2305	0,34	

Self-aligning ball bearings

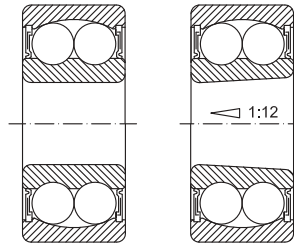

2RSR

K2RSR

d	Dimensions			Basic radial load. Factors						Speed limit		Designation	Mass
	D	B	r _s min.	dyn. C _r	e	Y ₁	Y ₂	stat. C _{0r}	Y ₀	grease	oil		
	mm			kN	-			kN	-	min ⁻¹		-	Kg
25	62	24	1,1	24,5	0,44	1,4	2,2	6,55	1,5	9500	12000	2305 K	0,34
	62	24	1,1	17,8	0,28	2,2	3,5	4,9	2,4	6300		2305 2RSR	0,33
30	62	16	1	15,7	0,25	2,5	3,9	4,7	2,7	10000	13000	1206	0,22
	62	16	1	15,7	0,25	2,5	3,9	4,7	2,7	10000	13000	1206 K	0,22
	62	20	1	15,3	0,4	1,6	2,5	4,6	1,7	9500	12000	2206	0,26
	62	20	1	15,3	0,4	1,6	2,5	4,6	1,7	9500	12000	2206 K	0,26
	62	20	1	15,3	0,4	1,6	2,5	4,6	1,7	9500	12000	2206 M	0,26
	62	20	1	15,7	0,25	2,5	3,9	4,7	2,7	5600		2206 2RSR	0,26
	62	20	1	15,7	0,25	2,5	3,9	4,7	2,7	5600		2206 K2RSR	0,26
	72	19	1,1	21,4	0,24	2,6	4,1	6,35	2,8	9000	11000	1306	0,38
	72	19	1,1	21,4	0,24	2,6	4,1	6,35	2,8	9000	11000	1306 K	0,38
	72	27	1,1	31,4	0,4	1,6	2,5	8,7	1,7	8500	10000	2306	0,5
35	72	27	1,1	31,4	0,4	1,6	2,5	8,7	1,7	8500	10000	2306 K	0,5
	72	27	1,1	21,4	0,24	2,6	4,1	6,35	2,8	5600		2306 2RSR	0,5
	72	17	1,1	15,8	0,23	2,8	4,2	5,15	2,9	9000	11000	1207	0,32
	72	17	1,1	15,8	0,23	2,8	4,2	5,15	2,9	9000	11000	1207 K	0,32
	72	17	1,1	15,8	0,23	2,8	4,2	5,15	2,9	9000	11000	1207 M	0,32
	72	23	1,1	21,7	0,37	1,7	2,6	6,7	1,8	8500	10000	2207	0,4
	72	23	1,1	21,7	0,37	1,7	2,6	6,7	1,8	8500	10000	2207 K	0,4
	72	23	1,1	15,8	0,23	2,8	4,2	5,15	2,9	5300		2207 RSR	0,4
	72	23	1,1	15,8	0,23	2,8	4,2	5,15	2,9	5300		2207 K2RSR	0,4
	80	21	1,5	25,1	0,25	2,5	3,9	7,95	2,7	7500	9000	1307	0,51
40	80	21	1,5	25,1	0,25	2,5	3,9	7,95	2,7	7500	9000	1307 K	0,51
	80	31	1,5	39,7	0,43	1,5	2,3	12,9	1,6	7000	8500	2307	0,67
	80	31	1,5	39,7	0,43	1,5	2,3	12,9	1,6	7000	8500	2307 K	0,67
	80	31	1,5	25,1	0,25	2,5	3,9	7,95	2,7	4500		2307 2RSR	0,67
	80	18	1,1	19,2	0,22	2,9	4,5	6,5	3	8500	10000	1208	0,41
	80	18	1,1	19,2	0,22	2,9	4,5	6,5	3	8500	10000	1208 K	0,41
	80	23	1,1	22,4	0,33	1,9	3	7,4	2	7500	9000	2208	0,5
	80	23	1,1	22,4	0,33	1,9	3	7,4	2	7500	9000	2208 K	0,5
	80	23	1,1	22,4	0,33	1,9	3	7,4	2	7500	9000	2208 M	0,5
	80	23	1,1	19,2	0,22	2,9	4,5	6,5	3	4800		2208 2RSR	0,5
45	80	23	1,1	19,2	0,22	2,9	4,5	6,5	3	4800		2208 K2RSR	0,5
	90	23	1,5	29,5	0,24	2,6	4,1	9,75	2,8	6700	8000	1308	0,71
	90	23	1,5	29,5	0,24	2,6	4,1	9,75	2,8	6700	8000	1308 K	0,71
	90	33	1,5	44,9	0,39	1,6	2,5	15,1	1,7	6300	7500	2308	0,92
	90	33	1,5	44,9	0,39	1,6	2,5	15,1	1,7	6300	7500	2308 K	0,92
	90	33	1,5	44,9	0,39	1,6	2,5	15,1	1,7	6300	7500	2308 M	0,92
	90	33	1,5	29,5	0,24	2,6	4,1	9,75	2,8	4000		2308 2RSR	0,92
	85	19	1,1	21,8	0,21	3	4,7	7,4	3,2	7500	9000	1209	0,46
	85	19	1,1	21,8	0,21	3	4,7	7,4	3,2	7500	9000	1209 K	0,46

Self-aligning ball bearings

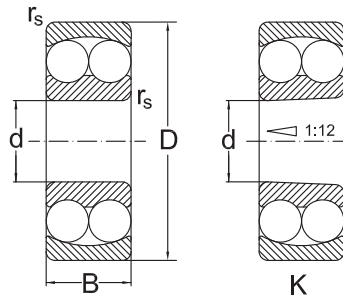

Dimensions				Basic radial load. Factors						Speed limit		Designation	Mass
d	D	B	r _s min.	dyn. C _r	e	Y ₁	Y ₂	stat. C _{0r}	Y ₀	grease	oil		
mm				kN	-			kN	-	min ⁻¹		-	Kg
45	85	23	1,1	23,3	0,31	2	3,1	8,15	2,1	7000	8500	2209	0,54
	85	23	1,1	23,3	0,31	2	3,1	8,15	2,1	7000	8500	2209 K	0,54
	85	23	1,1	21,8	0,21	3	4,7	7,4	3,2	4500		2209 2RSR	0,54
	85	23	1,1	21,8	0,21	3	4,7	7,4	3,2	4500		2209 K2RSR	0,54
	100	25	1,5	37,7	0,24	2,6	4,1	12,9	2,8	6300	7500	1309	0,95
	100	25	1,5	37,7	0,24	2,6	4,1	12,9	2,8	6300	7500	1309 K	0,95
	100	36	1,5	54,1	0,31	2	3,1	16,5	2,1	5600	6700	2309	1,23
	100	36	1,5	54,1	0,31	2	3,1	16,5	2,1	5600	6700	2309 K	1,23
50	100	36	1,5	37,7	0,24	2,6	4,1	12,9	2,8	3600		2309 2RSR	1,23
	90	20	1,1	22,9	0,21	3	4,7	8,16	3,2	7000	8500	1210	0,52
	90	20	1,1	22,9	0,21	3	4,7	8,16	3,2	7000	8500	1210 K	0,52
	90	23	1,1	23,3	0,29	2,2	3,4	8,5	2,3	6300	7500	2210	0,59
	90	23	1,1	23,3	0,29	2,2	3,4	8,5	2,3	6300	7500	2210 K	0,59
	90	23	1,1	22,9	0,21	3	4,6	8,1	3,2	4000		2210 2RSR	0,59
	90	23	1,1	22,9	0,21	3	4,6	8,1	3,2	4000		2210 K2RSR	0,59
	110	27	2	43,4	0,24	2,6	4,1	14,2	2,8	5600	6700	1310	1,21
	110	27	2	43,4	0,24	2,6	4,1	14,2	2,8	5600	6700	1310 K	1,21
	110	40	2	64,4	0,42	1,5	2,3	20	1,6	5300	6300	2310	1,23
55	110	40	2	64,4	0,42	1,5	2,3	20	1,6	5300	6300	2310 K	1,23
	110	40	2	43,4	0,24	2,6	4,1	14,2	2,8	3400		2310 2RSR	1,64
	100	21	1,5	26,6	0,2	3,2	4,9	10,1	3,3	6300	7500	1211	0,7
	100	21	1,5	26,6	0,2	3,2	4,9	10,1	3,3	6300	7500	1211 K	0,7
	100	25	1,5	26,5	0,27	2,3	3,6	9,9	2,5	6000	7000	2211	0,81
	100	25	1,5	26,5	0,27	2,3	3,6	9,9	2,5	6000	7000	2211 K	0,81
	120	29	2	51,3	0,23	2,8	4,2	18,1	2,9	5000	6000	1311	1,58
	120	29	2	51,3	0,23	2,8	4,2	18,1	2,9	5000	6000	1311 K	1,58
60	120	43	2	75,3	0,41	1,5	2,4	23,8	1,6	4800	5600	2311	2,1
	120	43	2	75,3	0,41	1,5	2,4	23,8	1,6	4800	5600	2311 K	2,1
	110	22	1,5	30,2	0,19	3,4	5,2	11,6	3,5	5600	6700	1212	0,9
	110	22	1,5	30,2	0,19	3,4	5,2	11,6	3,5	5600	6700	1212 K	0,9
	110	28	1,5	33,8	0,28	2,2	3,5	12,6	2,4	5300	6300	2212	1,1
	110	28	1,5	33,8	0,28	2,2	3,5	12,6	2,4	5300	6300	2212 K	1,1
	130	31	2,1	57,1	0,23	2,8	4,2	20,8	2,9	4500	5300	1312	1,96
	130	31	2,1	57,1	0,23	2,8	4,2	20,8	2,9	4500	5300	1312 K	1,96
65	130	46	2,1	87,1	0,41	1,5	2,4	28	1,6	4300	5000	2312	2,6
	130	46	2,1	87,1	0,41	1,5	2,4	28	1,6	4300	5000	2312 K	2,6
	120	23	1,5	31	0,17	3,7	5,7	12,4	3,9	5300	6300	1213	1,15
	120	23	1,5	31	0,17	3,7	5,7	12,4	3,9	5300	6300	1213 K	1,15
	120	31	1,5	43,6	0,28	2,2	3,5	16,4	2,4	5000	6000	2213	1,45
	120	31	1,5	43,6	0,28	2,2	3,5	16,4	2,4	5000	6000	2213 K	1,45
140	33	2,1	62	0,23	2,8	4,2	22,9	2,8	4300	5000	1313	2,45	

Self-aligning ball bearings

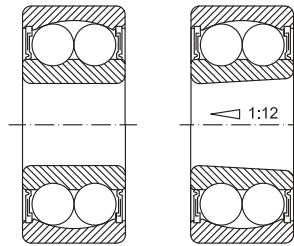

2RSR

K2RSR

Dimensions				Basic radial load. Factors						Speed limit		Designation	Mass
d	D	B	r _s min.	dyn. C _r	e	Y ₁	Y ₂	stat. C _{0r}	Y ₀	grease	oil		
mm				kN	-			kN	-	min ⁻¹		-	Kg
65	140	33	2,1	62	0,23	2,8	4,2	22,9	2,8	4300	5000	1313 K	2,45
	140	48	2,1	95,6	0,38	1,7	2,6	32,5	1,7	4000	4800	2313	3,25
	140	48	2,1	95,6	0,38	1,7	2,6	32,5	1,7	4000	4800	2313 K	3,25
70	125	24	1,5	34,6	0,18	3,5	5,4	13,7	3,7	5000	6000	1214	1,25
	125	24	1,5	34,6	0,18	3,5	5,4	13,7	3,7	5000	6000	1214 K	1,25
	125	31	1,5	44,2	0,27	2,3	3,6	17,1	2,5	4800	5600	2214	1,5
	125	31	1,5	44,2	0,27	2,3	3,6	17,1	2,5	4800	5600	2214 K	1,5
	150	35	2,1	74,1	0,22	2,9	4,5	27,7	3	4000	4800	1314	3
	150	35	2,1	74,1	0,22	2,9	4,5	27,7	3	4000	4800	1314 K	3
	150	51	2,1	111	0,35	1,8	2,8	31,7	1,9	3600	4300	2314	3,9
75	150	51	2,1	111	0,35	1,8	2,8	31,7	1,9	3600	4300	2314 K	3,9
	130	25	1,5	38,9	0,18	3,5	5,4	15,6	3,7	4800	5600	1215	1,35
	130	25	1,5	38,9	0,18	3,5	5,4	15,6	3,7	4800	5600	1215 K	1,35
	130	31	1,5	44	0,25	2,5	3,9	17,8	2,7	4500	5300	2215	1,6
	130	31	1,5	44	0,25	2,5	3,9	17,8	2,7	4500	5300	2215 K	1,6
	160	37	2,1	79,2	0,22	2,9	4,5	30	3	3600	4300	1315	3,55
	160	37	2,1	79,2	0,22	2,9	4,5	30	3	3600	4300	1315 K	3,55
	160	55	2,1	123	0,38	1,7	2,6	42,8	1,7	3400	4000	2315	4,7
80	160	55	2,1	123	0,38	1,7	2,6	42,8	1,7	3400	4000	2315 K	4,7
	160	55	2,1	123	0,38	1,7	2,6	42,8	1,7	3400	4000	2315 KM	4,7
	140	26	2	39,8	0,16	3,9	6,1	17	4,1	4300	5000	1216	1,65
	140	26	2	39,8	0,16	3,9	6,1	17	4,1	4300	5000	1216 K	1,65
	140	33	2	48,8	0,26	2,4	3,7	19,9	2,5	4000	4800	2216	2
	140	33	2	48,8	0,26	2,4	3,7	19,9	2,5	4000	4800	2216 K	2
	170	39	2,1	88,4	0,22	2,9	4,5	33	3	3400	4000	1316	4,2
	170	39	2,1	88,4	0,22	2,9	4,5	33	3	3400	4000	1316 K	4,2
85	170	58	2,1	136	0,34	1,9	2,9	48,5	2	3200	3800	2316	6,1
	170	58	2,1	136	0,34	1,9	2,9	48,5	2	3200	3800	2316 K	6,1
	170	58	2,1	136	0,34	1,9	2,9	48,5	2	3200	3800	2316 M	6,1
	150	28	2	48,2	0,17	3,7	5,7	20,8	3,9	4000	4800	1217	2,05
	150	28	2	48,2	0,17	3,7	5,7	20,8	3,9	4000	4800	1217 K	2,05
	150	36	2	58,5	0,25	2,5	3,9	23,8	2,7	3800	4800	2217	2,5
	150	36	2	58,5	0,25	2,5	3,9	23,8	2,7	3800	4800	2217 K	2,5
90	180	41	3	97,5	0,22	2,9	4,5	37,9	3	3200	3800	1317	5
	180	41	3	97,5	0,22	2,9	4,5	37,9	3	3200	3800	1317 K	5
	180	60	3	140	0,37	1,7	2,6	51,5	1,8	3000	3600	2317	7,05
	180	60	3	140	0,37	1,7	2,6	51,5	1,8	3000	3600	2317 K	7,05
	160	30	2	57	0,17	3,7	5,7	23,1	3,9	3800	4500	1218	2,5
90	160	30	2	57	0,17	3,7	5,7	23,1	3,9	3800	4500	1218 K	2,5
	160	40	2	70,2	0,27	2,3	3,6	27,2	2,5	3600	4300	2218	3,4
	160	40	2	70,2	0,27	2,3	3,6	27,2	2,5	3600	4300	2218 K	3,4

Self-aligning ball bearings

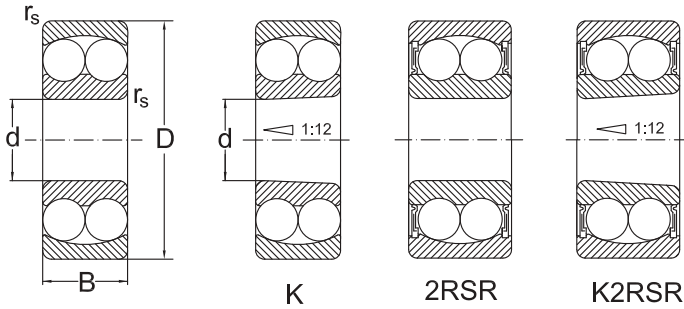

Dimensions				Basic radial load. Factors						Speed limit		Designation	Mass
d	D	B	$r_{s \text{ min.}}$	dyn. C_r	e	Y_1	Y_2	stat. C_{br}	Y_0	grease	oil		
mm				kN		-		kN	-	min ⁻¹		-	Kg
90	190	43	3	117	0,22	2,9	4,5	44,5	3	3000	3600	1318	5,8
	190	43	3	117	0,22	2,9	4,5	44,5	3	3000	3600	1318 K	5,8
	190	64	3	153	0,38	1,7	2,6	57,7	1,7	2800	3400	2318	8,45
	190	64	3	153	0,38	1,7	2,6	57,7	1,7	2800	3400	2318 K	8,45
95	170	32	2,1	63,7	0,17	3,7	5,7	24,3	3,9	3400	4000	1219	3,1
	170	32	2,1	63,7	0,17	3,7	5,7	24,3	3,9	3400	4000	1219 K	3,1
	200	45	3	133	0,23	2,8	4,2	50,8	2,9	2800	3400	1319	6,7
	200	45	3	133	0,23	2,8	4,2	50,8	2,9	2800	3400	1319 K	6,7
100	180	34	2,1	68,9	0,17	3,7	5,7	29,7	3,9	3200	3800	1220	3,7
	180	34	2,1	68,9	0,17	3,7	5,7	29,7	3,9	3200	3800	1220 K	3,7
	180	46	2,1	97,5	0,24	2,6	4,1	34	2,8	3200	3800	2220	5
	180	46	2,1	97,5	0,24	2,6	4,1	34	2,8	3200	3800	2220 K	5
	215	47	3	143	0,24	2,6	4,1	57,3	2,8	2600	3200	1320	8,3
	215	47	3	143	0,24	2,6	4,1	57,3	2,8	2600	3200	1320 K	8,3
	215	73	3	193	0,34	1,9	2,9	73,4	2	2400	3000	2320	12,2
110	215	73	3	193	0,34	1,9	2,9	73,4	2	2400	3000	2320 K	12,5
	200	38	2,1	88	0,17	3,7	5,7	35,2	3,9	2800	3400	1222	5,15
	200	38	2,1	88	0,17	3,7	5,7	35,2	3,9	2800	3400	1222 K	5,15
	200	53	2,1	124	0,26	2,4	3,7	48,9	2,5	2800	3400	2222	7,1
	200	53	2,1	124	0,26	2,4	3,7	48,9	2,5	2800	3400	2222 K	7,1
	240	50	3	163	0,22	2,9	4,5	67,5	3	2400	3000	1322	12
	240	50	3	163	0,22	2,9	4,5	67,5	3	2400	3000	1322 K	12



Angular contact ball bearings, single row

Single row angular contact bearings are manufactured in various constructive versions, with various contact angles, depending on the application. Bearings series 72B and 73B for general applications have a contact angle $\alpha = 40^\circ$. Bearings series 718, 719, 70 and 72 generally used for tool-holders, have

phenol resins (textolite) cages or machined brass cages. Those with bore diameters up to $d = 100$ mm are manufactured to tolerance classes P5, P4 and P2 and have a contact angle of $15^\circ(C)$ and $25^\circ(A)$ respectively.

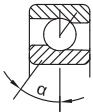

Series 72B, 73B
Contact angle $\alpha = 40^\circ$



Series 70A, 72A
Contact angle $\alpha = 25^\circ$

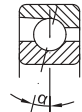

Series 70C, 72C
Contact angle $\alpha = 15^\circ$

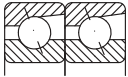

DT arrangement (Tandem)

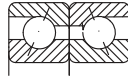

DB arrangement
(Back-to-back)

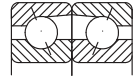

DF arrangement
(Face-to-face)

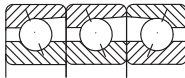

TFT arrangement

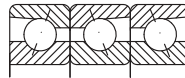

TBT arrangement

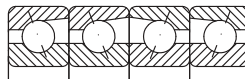

QFC arrangement

Suffixes

- A** - bearing with extended outer ring
- A** - bearing with contact angle $\alpha = 25^\circ$
- B** - bearing with extended outer ring
- B** - bearing with contact angle $\alpha = 40^\circ$
- BB** - bearing with $\alpha = 40^\circ$ and extended inner ring
- C** - bearing with contact angle $\alpha = 15^\circ$
- CA** - bearing with radial clearance smaller than normal
- CB** - bearing with normal radial clearance
- CC** - radial bearing with axial clearance larger than normal
- D** - two bearings set D - bearing with two-pieces inner ring
- DB** - two bearings set in back-to-back arrangement, (O)
- DF** - two bearings set in face-to-face arrangement, (X)
- DT** - two bearings set in tandem arrangement
- E** - bearing with contact angle $\alpha = 20^\circ$
- FA** - bearing with machined cage of steel or cast iron, guided in the outer ring
- FB** - bearing with machined cage of steel or cast iron, guided on the inner ring
- GA** - light preload, bearings series 72B, 73B
- GB** - moderate preload, bearings series 72B, 73B
- GC** - heavy preload, bearings series 72B, 73B
- L** - light preload, bearings series 70C, 70A, 72A
- M** - moderate preload, bearings series 70C, 70A, 72A
- M** - machined brass cage, ball guided
- MA** - machined brass cage, guided in the outer ring
- MB** - machined brass cage, guided in the inner ring
- O** - bearing set without axial clearance
- P0** - normal tolerance class
- P6** - tolerance class more accurate than normal
- P5** - tolerance class more accurate than P6
- P4** - tolerance class more accurate than P5
- P2** - tolerance class more accurate than P4
- Q** - four bearings set
- QFC** - tandem pairs in X arrangement
- S** - heavy preload, bearings series 70C, 70A, 72A
- SO** - bearings operating up to a temperature of $+150^\circ\text{C}$

- S1** - bearings operating up to a temperature of $+200^\circ\text{C}$
- T** - three bearings set
- T** - bearing set total width (T168, T200)
- TBT** - three bearings set in O arrangement, plus T
- TFT** - three bearings set in X arrangement, plus T
- TN** - polyamide cage
- V** - full complement bearing
- U** - bearings of universal design, with deviations of d and D and K_1 , K_0 in P2 class
- UA** - bearings with small axial clearance at DB and DF arrangements
- UL** - bearings with light preload at DB and DF arrangements
- UO** - bearings without small axial clearance at DB and DF arrangements
- UP** - tolerance class with deviations of d and D in P4 class and of K_1 and K_0 in P2 class.

Single row angular contact ball bearings can take only one direction axial loads. When being radially loaded, in bearing occurs an axially acting load which has to be compensated.

For this reason, a bearing or paired bearings are mounted on each shaft end.

Single row angular contact ball bearings with B suffix have a contact angle $\alpha = 40^\circ$ and are suitable in case of heavy loads.

These bearings are not dismountable and their use at relatively high speeds is allowed.

Pair mounting of bearings as shown in figures on page 133 is used when the load carrying capacity of a single bearing is inadequate (tandem arrangement), respectively when axial loads have to be taken in both directions (DB or DF arrangements).

In case of DT tandem arrangement, the contact lines are in parallel. Radial and axial loads are uniformly distributed on both bearings. The bearing pair can take axial loads in only one direction. Therefore, a third bearing should take axial loads in the opposite direction.

DB arrangement is considered to be a relatively stiff arrangement and can also take tilting moments.

The contact lines of DF arrangement converge

towards the bearing axis and form letter "X". Axial loads are taken in the same way as in case of DB arrangement, but the arrangement is not so stiff and it is less suitable for taking tilting moments.

Universal design

Single row angular contact ball bearings of universal design are suitable for DB, DF and DT arrangements.

Bearings of universal design are manufactured to more accurate tolerance classes and can be matched if the mounting conditions UA, UO and UL are observed.

The values of clearance or preload are obtained when the shaft is manufactured to tolerance class J5 and the housing bore to tolerance class J6.

Dimensions

Main dimensions of bearings given in tables are in accordance with ISO 15.

Misalignment

In case of single row angular contact ball bearings the conditions regarding the permissible error of

alignment of the outer ring relative to the inner ring are as complex as for single row deep groove ball bearings.

When the bearings are paired in DB arrangement, angular misalignments of the outer ring in relation to the inner ring can only be accommodated between the balls and raceways by force, leading to a reduction in bearing life.

Tolerances

Single row angular contact ball bearings of series 72B and 73B, with a contact angle $\alpha = 40^\circ$ (B) are generally manufactured to the normal tolerance class.

At request, they also can be manufactured to normal tolerance classes P6 and P5.

The deviations of bore diameter, outside diameter and width of high accuracy single row angular contact ball bearings of universal design (UL) are given in table 1.

In case of single row angular contact ball bearings manufactured and delivered in sets of 2, 3 or 4 bearings, outside and bore diameter should be chosen considering the mean tolerance values, which are given on the package.

Deviations of main dimensions of high accuracy row angular contact bearings									
Deviations in μm									
Bore									
d		Δd_{mp} , ΔD_{mp}				ΔB_s			
over	up to	low	high	low	high	low	high	low	high
(mm)		P4		UP		P2			
-	18	-3		-3		-2	0	-250	0
18	30	-3,5	-1,5	-3		-2	0	-250	0
30	50	-4	-1,5	-3		-2	0	-250	0
50	80	-5	-2	-3,5	-1,5	-3		-250	0
80	120	-5,5	-2			-3,5	-1,5	-380	0

Contact angle

In case of single row angular contact ball bearings, the efforts between rings and rolling elements (contact points of rolling elements / outer or inner ring) are transmitted at an angle $\alpha (<90^\circ)$ to a plane perpendicular to the bearing axis.

The value of this angle depends on the magnitude of the raceway radius, rolling element diameter and radial clearance in bearing, when the curvature centres of the raceway in the outer or in the inner ring are in the same plane.

Axial clearance - preload

Axial clearance or preload can be obtained only when single row angular contact ball bearings is mounted in the assembly and depends on the location of the second bearing which assures the shaft axial guiding.

Single row angular contact ball bearings series 72B and 73B, paired mounted in DB and DF arrangements are manufactured with normal axial clearance CB, smaller than normal, CA, larger than normal, CC, or with light preload, GA, moderate preload GB, or heavy preload, GC, according to the values given in table 2.

Axial clearance or preload of single row angular contact ball bearings series 72B and 73B, pair mounted in DB or DF arrangements																				Table 2
Bore		Axial clearance						Preload												
d		CA		CB		CC		GA			GB				GC					
over	up to	min.	max.	min.	max.	min.	max.	min.	max.	min.	min.	max.	min.	max.	min.	max.	min.	max.	min.	max.
mm	µm	µm						N			µm				µm					
-	10	4	12	14	22	22	30	-	-	-	-	-	-	-	-	-	-	-	-	-
10	18	5	13	15	23	24	32	4	-4	80	-2	-10	30	330	-8	-16	230	260		
18	30	7	15	18	26	32	40	4	-4	120	-2	-10	40	480	-8	-16	340	970		
30	50	9	17	22	30	40	48	4	-4	160	-2	-10	60	630	-8	-16	450	1280		
50	80	11	23	26	38	48	60	6	-6	380	-3	-15	140	1500	-12	-24	1080	3050		
80	120	14	26	32	44	55	67	6	-6	410	-3	-15	150	1600	-12	-24	1150	3250		
120	180	17	29	35	47	62	74	6	-6	540	-3	-15	200	2150	-12	-24	1500	4300		
180	250	21	37	45	61	74	90	8	-8	940	-4	-20	330	3700	-16	-32	2650	7500		
250	315	26	42	52	68	90	106	8	-8	1080	-4	-20	380	4250	-16	-32	3000	8600		

High accuracy single row angular contact ball bearings series 70C, 70A and 72A, with a contact angle $\alpha = 15^\circ$ (C) and $\alpha = 25^\circ$ (A), which are generally used for grinding stone holders, paired mounted in

DB and DF arrangement, are manufactured with an initial preload. It can be: light (L), moderate (M), heavy (S). The values of these preloads are given in table 3.

Values of axial preload of bearings of series 70C, in DB and DF arrangements														Table 3
Bore		Axial preload												
		Series 70C			Series 72C			Series 70A			Series 72A			
d	Symbol	L	M	S	L	M	S	L	M	S	L	M	S	
mm	-	N												
10	0	15	30	60	20	40	80	25	50	100	35	70	140	
12	1	15	30	60	20	40	80	25	50	100	35	70	140	
15	2	20	40	80	30	60	120	30	60	120	45	90	180	
17	3	25	50	100	35	70	140	40	80	160	60	120	240	
20	4	35	70	140	45	90	180	50	100	200	70	140	280	
25	5	35	70	140	50	100	200	60	120	240	80	160	320	
30	6	50	100	200	90	180	360	90	180	360	150	300	600	
35	7	60	120	240	120	240	480	90	180	360	190	380	760	
40	8	60	120	240	150	300	600	100	200	400	240	480	960	
45	9	110	220	440	160	320	640	170	340	680	260	520	1040	
50	10	110	220	440	170	340	680	180	360	720	260	520	1040	
55	11	150	300	600	210	420	840	230	460	920	330	660	1320	
60	12	150	300	600	250	500	1000	240	480	960	400	800	1600	

Values of axial preload of bearings of series 70C, in DB and DF arrangements

Table 3 (continued)

Bore		Axial preload											
		Series 70C			Series 72C			Series 70A			Series 72A		
d	Symbol	L	M	S	L	M	S	L	M	S	L	M	S
mm	-	N											
65	13	160	320	640	290	580	1160	240	480	960	450	900	1800
70	14	200	400	800	300	600	1200	300	600	1200	480	960	1920
75	15	200	400	800	310	620	1240	310	620	1240	500	1000	2000
80	16	240	480	960	370	740	1480	390	780	1560	580	1160	2320
85	17	250	500	1000	370	740	1480	400	800	1600	600	1200	2400
90	18	300	600	1200	480	960	1920	460	920	1840	750	1500	3000
95	19	310	620	1240	520	1040	2080	480	960	1920	850	1700	3400
100	20	310	620	1240	590	1180	2360	500	1000	2000	950	1900	3800
105	21	360	720	1440	650	1300	2600	560	1120	2240	1000	2000	4000
110	22	420	840	1680	670	1340	2680	650	1300	2600	1050	2100	4200
120	24	430	860	1720	750	1500	3000	690	1380	2760	1200	2400	4800
130	26	560	1120	2240	800	1600	3200	900	1800	3600	1250	2500	5000
140	28	570	1140	2280	-	-	-	900	1800	3600	-	-	-
150	30	650	1300	2600	-	-	-	1000	2000	4000	-	-	-
160	32	730	1460	2920	-	-	-	1150	2300	4600	-	-	-
170	34	800	1600	3200	-	-	-	1250	2500	5000	-	-	-
180	36	900	1800	3600	-	-	-	1450	2900	5800	-	-	-
190	38	950	1900	3800	-	-	-	1450	2900	5800	-	-	-

Designs of single row angular contact ball bearings with clearance or initial preload are given in the figures below:

Before mounting (preload)



After mounting (preload)

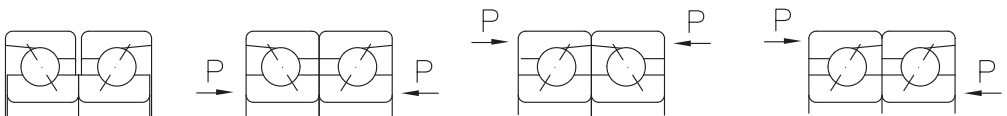

Cages

Single row angular contact ball bearings series 72B and 73B are generally fitted with pressed sheet cages.

At special request (high speeds, large sizes), bearing series 70C, 72C, 70A and 72A are fitted

with machined brass cages. Cages of glass fibre reinforced polyamide 6.6 are also used with good results if operating temperature doesn't exceed +120°C.

Cages design and some technical data are given in table 4.

Cage design and technical data

Table 4

Cage	Design		Application	Max. value D _m n	
	bearing	cage		oil	grease
mm	-	N			
Pressed sheet cage			<ul style="list-style-type: none"> - General application - Moderate speeds - Bearing series 72B, 73B 	600x10 ³	450x10 ³
Machined brass cage M, MA, MB			<ul style="list-style-type: none"> - General application - High speeds - Bearings 7231B-7238B, 7310B-7338B 	1100x10 ³	800x10 ³
Polyamide cage TN			<ul style="list-style-type: none"> - General application - Low friction moments - High speeds 	1100x10 ³	900x10 ³
Textolite cage T, TA, TB			<ul style="list-style-type: none"> - High accuracy bearing series 70C, 72C, 70A, 72A - High speeds - Low vibration level 	1200x10 ³	900x10 ³

Equivalent dynamic radial load

For single row angular contact ball bearings series 72B and 73B, single and in tandem arrangement the following equations are used:

$$P_r = F_r, \text{ kN,} \quad \text{when } F_a/F_r < 1,14,$$

$$P_r = 0,35 F_r + 0,57 F_a, \text{ kN,} \quad \text{when } F_a/F_r > 1,14$$

For bearings in DB or DF arrangement

$$P_r = F_r + 0,65 F_a, \text{ kN} \quad \text{when } F_a/F_r < 1,14$$

$$P_r = 0,57 F_r + 0,93 F_a, \text{ kN,} \quad \text{when } F_a/F_r > 1,14$$

In case of paired bearings, F_r and F_a are the loads acting upon the bearings pair.

As the load is transmitted from one raceway to the other under a certain angle to the bearings axis, the actual load will cause an axial load. This has to be considered when calculating the equivalent dynamic load, in case of two single bearings or tandem

arrangements. The equations needed for calculation are given in table 5, for various arrangements and loading versions.

These equations are available for bearings mounted without clearance and without preload (clearance equal to zero).

For single row angular contact ball bearings series 70C and 72C with a contact angle $\alpha = 15^\circ(\text{C})$, single or in DT arrangement, the following equations are available:

$$P_r = F_r, \text{ kN,} \quad \text{for } F_a/F_r < e,$$

$$P_r = 0,44 F_r + Y F_a, \text{ kN,} \quad \text{for } F_a/F_r > e$$

The values of factor Y depend on the values of the ratio $f_0 i F_a / C_{0r}$ and are given in table 6. Factor f_0 can be found in diagram in page 140 as a function of dimensions series and bearing mean diameter. "i" represents the number of bearings or bearings pairs in a bearing join.

Back to back arrangement
DB

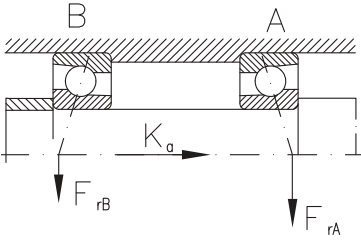

Face to face arrangement
DF

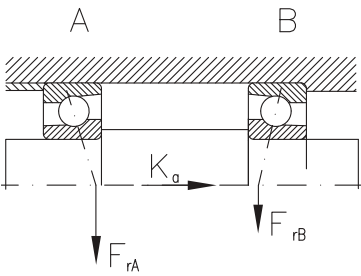

Back to back arrangement
DB

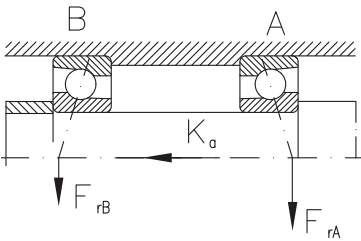

Face to face arrangement
DF

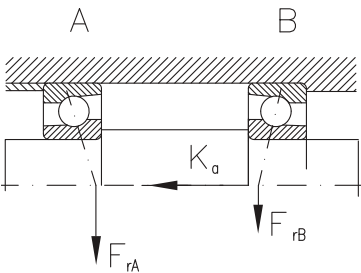

For bearings in DB and DF arrangements, the following equations are available:

$$P_r = F_r + Y_1 F_a, \text{ kN}, \quad \text{for } F_a/F_r < e,$$

$$P_r = 0,72 F_r + Y_2 F_a, \text{ kN}, \quad \text{for } F_a/F_r > e$$

The values of factors Y_1 and Y_2 depend on the ratio $f_0 i F_a / C_{0r}$ and are given in table 6 (f_0 from diagram below).

Determination of axial loads

Table 5

Loading version	Axial load
1a) $F_{rA} \geq F_{rB}$ $K_a \geq 0$	$F_{aA} = 1,14 F_{rA}$ $F_{aB} = F_{aA} + K_a$
1b) $F_{rA} < F_{rB}$ $K_a \geq 1,14 (F_{rB} - F_{rA})$	$F_{aA} = 1,14 F_{rA}$ $F_{aB} = F_{aA} + K_a$
1c) $F_{rA} < F_{rB}$ $K_a \leq 1,14 (F_{rB} - F_{rA})$	$F_{aB} = F_{aB} - K_a$ $F_{aB} = 1,14 F_{rB}$
2a) $F_{rA} \leq F_{rB}$ $K_a \geq 0$	$F_{aB} = F_{aB} + K_a$ $F_{aB} = 1,14 F_{rB}$
2b) $F_{rA} > F_{rB}$ $K_a \geq 1,14 (F_{rA} - F_{rB})$	$F_{aB} = F_{aB} + K_a$ $F_{aB} = 1,14 F_{rB}$
2c) $F_{rA} > F_{rB}$ $K_a < 1,14 (F_{rA} - F_{rB})$	$F_{aA} = 1,14 F_{rA}$ $F_{aB} = F_{aA} - K_a$

For single row angular contact ball bearings series 70A and 72A, with a contact angle $\alpha = 25^\circ$, single or in DT arrangement, the following equation are available:

$$P_r = F_r, \text{ kN, for } F_a/F_r < 0,68$$

$$P_r = 0,41 F_r + 0,87 F_a, \text{ kN, for } F_a/F_r > 0,68$$

For bearings in DB and DF arrangement, the following equations are available:

$$P_r = F_r + Y_1 F_a, \text{ kN, for } F_a/F_r < e$$

$$P_r = 0,72 F_r + Y_2 F_a, \text{ kN, for } F_a/F_r > e$$

Values for Y_1 and Y_2 are given in table 6.

$\frac{f_0 i F_a}{C_{Or}}$	Single and DT Arrangement DB or DF			
	e	Y	Y_1	Y_2
0,2	0,38	1,46	1,64	2,37
0,4	0,41	1,36	1,52	2,21
0,8	0,44	1,28	1,44	2,11
1,6	0,48	1,16	1,31	1,90
3	0,52	1,08	1,21	1,78
6	0,56	1	1,12	1,66

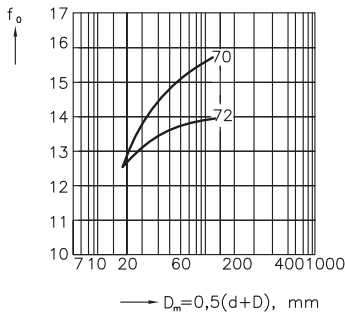

Equivalent static load

For single row angular contact ball bearings series 72B and 73B with a contact angle $\alpha = 40^\circ$, single and in DT arrangement, the following equation is available:

$$P_{Or} = 0,6 F_r + 0,26 F_a, \text{ kN}$$

If $P_{Or} < F$ then we consider $P_0 = F_r$

For bearings in DB and DT arrangement, the following equation is available:

$$P_{Or} = F_r + 0,52 F_a, \text{ kN}$$

For single row angular contact ball bearings series

70C and 72C, with a contact angle $\alpha = 15^\circ$, single and in DT arrangement, the following equation is available:

$$P_{Or} = 0,5 F_r + 0,46 F_a, \text{ kN}$$

For bearings in DB and DF arrangement, the following equation is available:

$$P_{Or} = 0,5 F_r + 0,92 F_a, \text{ kN}$$

For single row angular contact ball bearings series 70A and 72A with a contact angle $\alpha = 25^\circ$, single and in DT arrangement, the following equation is available:

$$P_{Or} = 0,5 F_r + 0,38 F_a, \text{ kN}$$

For bearings in DB and DF arrangement, the following equation is available:

$$P_{Or} = F_r + 0,76 F_a, \text{ kN}$$

Two "V" scratches are marked on the outside surface where the runout is maximum, i.e. where the outer ring thickness is maximum, so that the bearings of a set can be mounted in the manufacturing order. The place of maximum runout is marked on the chamfer between the inner ring bore and side face. Thus, the possible fit ovalnesses on the shaft can be compensated.

Every set is delivered as an unit, separately packed. In each unit, bearings are singly packed.

If distance rings are necessary to be mounted between bearings, they have not to be adjusted when being mounted. There is only one condition to be observed: the inner distance ring width should be equal to that of the outer ring, the side faces being parallel to each other. This can be easily done if both distance rings are simultaneously ground on a grinding and lapping machine. If bearings are mounted with distance rings, the mounting is also done observing the "V" marked as mentioned above. The cone vertex should be on the ring side opposite to that one on which the load acts (see next figure).

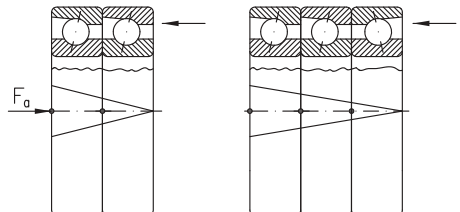

Basic dynamic load of paired bearings

Basic dynamic load given in bearings tables is valid for each single bearing. Basic dynamic load of a paired bearings set can be determined according to the specifications on page 20-21.

Basic static load of paired bearings

Basic static load of paired bearings can be similarly determined, multiplying the values of CO_r in the tables by 2, 3 and 4 respectively.

Bearing speed limit

Single row angular contact ball bearings are used at high speeds.

The values of speeds for bearings series 72B and 73B, normal tolerance class, without preload are given in this catalogue.

In case of preloaded bearings, for single mounted bearing and bearings in DB, DF or DT arrangements, speed should be multiplied by the coefficients in table 7.

For bearings series 70C, 72C, 70A and 72A, speeds are given for the tolerance class P4 and light preload.

In case of bearings with other values of preloads or arrangements of 3 or 4 bearing sets, the speeds of the bearing of basic design should be multiplied by the values of the coefficients in table 7.

Arrangement	Bearing preload			
	UA,UO	L	M	S
Single	1,0	1,0	0,90	0,80
Tandem, DT	0,90	0,90	0,80	0,65
Back-to-back, DB	0,80	0,80	0,70	0,55
Face-to-face, DF	0,80	0,75	0,60	0,40
Three bearings set	0,75	0,70	0,55	0,35
Four bearings set	0,70	0,65	0,45	0,25

Abutment dimensions

For a proper location of bearing rings on the shaft and housing shoulder respectively, shaft (housing) maximum connection radius $r_{u\max}$ should be less than bearing minimum mounting chamfer $r_{1\min}, r_{2\min}$.

Shoulder height should also be properly sized in case of bearing maximum mounting chamfer.

The values of the connection radii and support shoulder height are given in table 8.

$r_{s'}, r_{1s}$ min	$r_{s'}, r_{1s}$ max	h_u, h_{u1} min	
		Bearing series	
		718, 728, 719, 729, 70	72 73
mm			
0,3	0,3	1	1,2
0,6	0,6	1,6	2,1
1	1	2,3	2,6
1,1	1	3	3,5
1,5	1,5	3,5	4,5
2	2	4,4	5,5
2,1	2,1	5,1	6
3	2,5	6,2	7
4	3	7,3	8,5

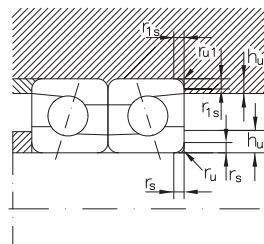
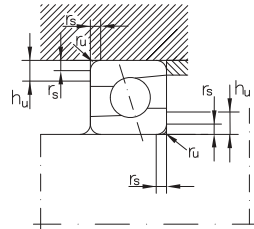

Angular contact ball bearing, single row

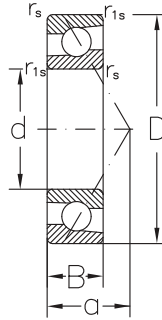

Dimensions					Basic radial load			Speed limit		Designation	Mass
d	D	B	r _s min.	r _{1s} min.	a	dyn. C _r	stat. C _{0r}	grease	oil		
mm					kN			min ⁻¹		-	Kg
10	30	9	0,6	0,3	13	4,95	2,5	19000	28000	7200B	0,031
12	32	10	0,6	0,3	14	7,4	3,75	17000	24000	7201B	0,045
15	35	11	0,6	0,3	16	7,45	3,9	16000	22000	7202B	0,048
	35	11	0,6	0,3	16	7,45	3,9	16000	22000	7202BP6	0,048
	35	11	0,6	0,3	16	7,45	3,9	16000	22000	7202BP5	0,048
17	42	13	1	0,6	19	12,9	6,5	14000	19000	7302B	0,090
	40	12	0,6	0,6	18	11	6,1	14000	19000	7203B	0,070
	40	12	0,6	0,6	18	11	6,1	14000	19000	7203BP6	0,070
	40	12	0,6	0,6	18	11	6,1	14000	19000	7203BP5	0,070
	40	12	0,6	0,6	18	11	6,1	14000	19000	7203 BTN	0,064
20	47	14	1	0,6	21	14,8	8,1	12000	17000	7303B	0,120
	47	14	1	0,6	21	14,1	8,4	11000	16000	7204B	0,110
	47	14	1	0,6	21	14,1	8,4	11000	16000	7204BP6	0,110
	47	14	1	0,6	21	14,1	8,4	11000	16000	7204BP5	0,110
	52	15	1,1	0,6	23	17,3	9,7	10000	15000	7304B	0,150
25	52	15	1,1	0,6	23	17,3	9,7	10000	15000	7304BP6	0,150
	52	15	1,1	0,6	23	17,3	9,7	10000	15000	7304 BEP	0,15
	52	15	1	0,6	24	15,5	10,1	9500	14000	7205B	0,130
	52	15	1	0,6	24	15,5	10,1	9500	14000	7205BP6	0,130
	52	15	1	0,6	24	15,5	10,1	9500	14000	7205BP5	0,130
30	62	17	1,1	0,6	27	24,4	14,6	8500	12000	7305B	0,250
	62	17	1,1	0,6	27	24,4	14,6	8500	12000	7305BP6	0,250
	62	17	1,1	0,6	27	24,4	14,6	8500	12000	7305AMA	0,250
	62	17	1,1	0,6	27	24,4	14,6	8500	12000	7305 BEP	0,25
	62	16	1	0,6	27	20,5	13,6	8500	12000	7206B	0,210
35	62	16	1	0,6	27	20,5	13,6	8500	12000	7206BP6	0,210
	62	16	1	0,6	27	20,5	13,6	8500	12000	7206BP5	0,210
	62	16	1	0,6	27	20,5	13,6	8500	12000	7206ATAP2	0,210
	72	19	1,1	0,6	31	29,3	19	7500	10000	7306B	0,370
	72	19	1,1	0,6	31	29,3	19	7500	10000	7306BP6	0,370
	72	19	1,1	0,6	31	29,3	19	7500	10000	7306BP5	0,370
	72	19	1,1	0,6	31	29,3	19	7500	10000	7306AMA	0,370
	72	19	1,1	0,6	31	29,3	19	7500	10000	7306 BEP	0,37
40	72	19	1,1	0,6	31	29,3	19	7500	10000	7306 BTN	0,341
	72	17	1,1	0,6	31	28,5	19,8	7500	10000	7207B	0,300
	72	17	1,1	0,6	31	28,5	19,8	7500	10000	7207BP5	0,300
	72	17	1,1	0,6	31	28,5	19,8	7500	10000	7207 BTN	0,282
40	80	21	1,5	1	35	36,7	24,3	7000	9500	7307B	0,510
	80	21	1,5	1	35	36,7	24,3	7000	9500	7307BP5	0,510
	80	18	1,1	0,6	34	32,1	23	6700	9000	7208B	0,390
	80	18	1,1	0,6	34	32,1	23	6700	9000	7208BP6	0,390
	80	18	1,1	0,6	34	32,1	23	6700	9000	7208BP5	0,390

Angular contact ball bearing, single row

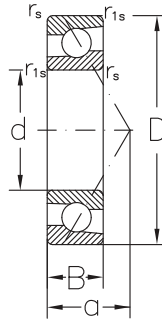

Dimensions					Basic radial load			Speed limit		Designation	Mass
d	D	B	r _s min.	r _{1s} min.	a	dyn. C _r	stat. C _{0r}	grease	oil		
mm					kN			min ⁻¹		-	Kg
40	90	23	1,5	1	39	44,8	30,3	6300	8500	7308B	0,670
	90	23	1,5	1	39	44,8	30,3	6300	8500	7308 BEP	0,67
	90	23	1,5	1	39	44,8	30,3	6300	8500	7308BP6	0,670
	90	23	1,5	1	39	44,8	30,3	6300	8500	7308BP5	0,670
45	85	19	1,1	0,6	37	36,1	26,2	6300	8500	7209B	0,440
	85	19	1,1	0,6	37	36,1	26,2	6300	8500	7209BP5	0,440
	100	25	1,1	0,6	37	36,1	26,2	6300	8500	7309 BTN	0,813
	100	25	1,5	1	43	58,3	40,1	5600	7500	7309B	0,900
	100	25	1,1	0,6	37	36,1	26,2	6300	8500	7309 BEP	0,900
	100	25	1,5	1	43	58,3	40,1	5600	7500	7309BP6	0,900
	100	25	1,5	1	43	58,3	40,1	5600	7500	7309BP5	0,900
50	90	20	1,1	0,6	39	37,4	28,6	5600	7500	7210B	0,490
	90	20	1,1	0,6	39	37,4	28,6	5600	7500	7210BP6	0,490
	90	20	1,1	0,6	39	37,4	28,6	5600	7500	7210BP5	0,490
	110	27	1,1	0,6	39	37,4	28,6	5600	7500	7310 BTN	1,05
	110	27	2	1	47	68,2	47,9	5000	6700	7310B	1,15
	110	27	2	1	47	68,2	47,9	5000	6700	7310BP6	1,15
	110	27	2	1	47	68,2	47,9	5000	6700	7310BP5	1,15
55	100	21	1,5	1	43	46,2	36,2	5300	7000	7211B	0,650
	100	21	1,5	1	43	46,2	36,2	5300	7000	7211 AA	0,64
	120	29	2	1	52	78,8	56,4	4500	6000	7311B	1,45
	120	29	2	1	52	78,8	56,4	4500	6000	7311 BTN	1,38
	120	29	2	1	52	78,8	56,4	4500	6000	7311 BCBY	1,441
60	110	22	1,5	1	47	56,3	44,7	4800	6300	7212B	0,840
	110	22	1,5	1	47	56,3	44,7	4800	6300	7212BP5	0,840
	110	22	1,5	1	47	56,3	44,7	4800	6300	7212 BTN	0,777
	130	31	2,1	1,1	56	90	65,5	4300	5600	7312B	1,85
	130	31	2,1	1,1	56	90	65,5	4300	5600	7312BP5	1,85
	130	31	2,1	1,1	56	90	65,5	4300	5600	7312 BECBP	1,85
	130	31	2,1	1,1	56	90	65,5	4300	5600	7312 BTN	1,71
65	120	23	1,5	1	50	63,6	52,5	4300	5600	7213B	1,05
	120	23	1,5	1	50	63,6	52,5	4300	5600	7213BP6	1,05
	120	23	1,5	1	50	63,6	52,5	4300	5600	7213BP5	1,05
	140	33	1,5	1	50	63,6	52,5	4300	5600	7313 BTN	2,12
	140	33	2,1	1,1	60	101	75,3	4000	5300	7313B	2,25
70	125	24	1,5	1	53	69,1	57,8	4300	5600	7214B	1,15
	125	24	1,5	1	53	69,1	57,8	4300	5600	7214 BTN	1,08
	150	35	2,1	1,1	64	114	86	3800	5000	7314B	2,75
	150	35	2,1	1,1	64	114	86	3800	5000	7314 BEP	2,75
	150	35	2,1	1,1	64	114	86	3800	5000	7314BP6	2,75
150	35	2,1	1,1	64	114	86	3800	5000	7314BP5	2,75	

Angular contact ball bearing, single row

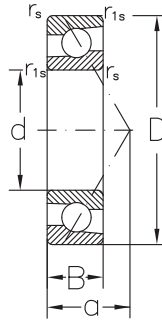

Dimensions						Basic radial load		Speed limit		Designation	Mass
d	D	B	r _s min.	r _{1s} min.	a	dyn. C _r	stat. C _{0r}	grease	oil		
mm						kN		min ⁻¹		-	Kg
70	150	35	2,1	1,1	64	114	86	3800	5000	7314BTN	2,75
	130	25	1,5	1	56	74,8	63,2	4000	5300	7215B	1,30
	130	25	1,5	1	56	74,8	63,2	4000	5300	7215BP6	1,30
	130	25	1,5	1	56	74,8	63,2	4000	5300	7215BTN	1,16
75	160	37	2,1	1,1	68	125	97,5	3400	4500	7315B	3,30
	160	37	2,1	1,1	68	125	97,3	3400	4500	7315BMAP6	3,30
	160	37	2,1	1,1	68	125	97,5	3400	4500	7315AMA	3,30
	160	37	2,1	1,1	68	125	97,5	3400	4500	7315 BEGAM	3,30
	160	37	2,1	1,1	68	125	97,5	3400	4500	7315 BTN	3,1
	140	26	2	1	59	80,5	69,3	3800	5000	7216B	1,55
80	140	26	2	1	59	80,5	69,3	3800	5000	7216 BTN	1,42
	170	39	2,1	1,1	72	135	109	3200	4300	7316B	3,90
	170	39	2,1	1,1	72	135	109	3200	4300	7316 BTN	3,66
	170	39	2,1	1,1	72	135	109	3200	4300	7316BP6	3,903
	170	39	2,1	1,1	72	135	109	3200	4300	7316BMAP6	3,903
	150	28	2	1	64	93,1	81,1	3400	4500	7217B	1,953
85	180	41	3	1,1	76	145	122	3000	4000	7317B	4,603
	180	41	3	1,1	76	145	122	3000	4000	7317BP6	4,603
	180	41	3	1,1	76	145	122	3000	4000	7317BMP6	4,603
90	160	30	2	1	67	107	93,8	3200	4300	7218B	2,403
	160	30	2	1	67	107	93,8	3200	4300	7218BMB	2,403
	160	30	2	1	67	107	93,8	3200	4300	7218 BTN	2,21
	190	43	3	1,1	80	156	135	2800	3800	7318B	5,403
95	190	43	3	1,1	80	156	135	2800	3800	7318 BTN	5
	170	32	2,1	1,1	71	116	101	3000	4000	7219B	2,903
	170	32	2,1	1,1	71	116	101	3000	4000	7219 BTN	2,64
100	200	45	3	1,1	84	168	150	2600	3600	7319B	6,253
	180	34	2,1	1,1	76	129	116	2800	3800	7220B	3,453
	180	34	2,1	1,1	76	129	116	2800	3800	7220BP6	3,453
	180	34	2,1	1,1	76	129	116	2800	3800	7220BMA	3,453
	180	34	2,1	1,1	76	129	116	2800	3800	7220BMAP6	3,453
	180	34	2,1	1,1	76	129	116	2800	3800	7220BMAP4	3,453
	180	34	2,1	1,1	76	129	116	2800	3800	7220BMB	3,453
	180	34	2,1	1,1	76	129	116	2800	3800	7220 BM	3,6
	215	47	3	1,1	90	190	178	2400	3400	7320B	7,753
	215	47	3	1,1	90	190	178	2400	3400	7320BP6	7,753
	215	47	3	1,1	90	190	178	2400	3400	7320 M	7,75
110	215	47	3	1,1	90	190	178	2400	3400	7320BM	7,753
	200	38	2,1	1,1	84	153	145	2400	3400	7222B	4,803
	200	38	2,1	1,1	84	153	145	2400	3400	7222BMB	4,803
	240	50	3	1,1	99	248	229	2000	3000	7322B	10,53

Angular contact ball bearing, single row

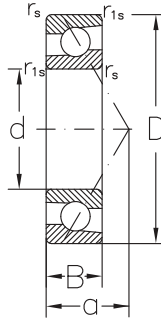

Dimensions						Basic radial load		Speed limit		Designation	Mass
d	D	B	r_s min.	r_{1s} min.	a	dyn. C_r	stat. C_{0r}	grease	oil		
mm						kN		min ⁻¹		-	Kg
110	240	50	3	1,1	99	248	229	2000	3000	7322BP5	10,53
	240	50	3	1,1	99	248	229	2000	3000	7322BM	10,53
140	250	42	3	1,1	103	191	210	1700	2400	7228B	8,803
	300	62	4	1,5	123	290	334	1700	2400	7328B	21,63
	300	62	4	1,5	123	290	334	1700	2400	7328BMBP5	21,63
150	190	24	1,1	0,6	35	60,5	79,2	2200	3000	72830CMA	3,363
	270	45	3	1,1	111	195	222	2000	2800	7230BM	11,63
	320	65	4	1,5	131	317	380	1600	2000	7330BM	26,53
	320	65	4	1,5	131	317	380	1600	2000	7330 M	26,53
	320	65	4	1,5	131	317	380	1600	2000	7330BMP5	26,53
160	220	28	2	1	58	110	134	2200	3000	71932AMAP5	3,263
180	250	33	2	2	33	131	162	2000	2800	71936AM	5,36
200	250	30	1,5	0,6	45	102	141	3000	5600	72840CMAP4	3,43

ART BEARINGS



Cylindrical roller bearings

Cylindrical roller bearings are manufactured in a various range of constructive types and sizes, particularly single row cylindrical roller bearings but also two or more row cylindrical roller bearings, with cages or roller by roller, as shown in the designs below.

In case of cylindrical roller bearings, the rollers are laterally guided by the fixed ribs of one ring.

In case of bearings with cages, the ring with ribs and the rollers retained in the cage can be drawn out from the other ring, which means that these bearings are dismountable.

Therefore, bearings from joints can be much easier mounted and dismantled, especially where interference fits are needed for both rings due to the loading conditions.

Bearings are provided with unloaded rollers at both generatrix ends. Therefore, the linear contact between rollers and rings alters advantageously, i.e. peripheral stresses are avoided.

- single row
- double row
- without cage (full complement)

- single row



NU



NJ



NUP



N



RNU



NJ+HJ



NU+HJ

- double row

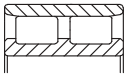

NN30

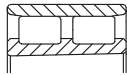

NN30K

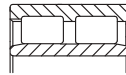

NNU49

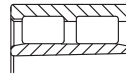

NNU49K

- without cage (full complement)



NCF V



NJ VH

Suffixes

- AR** - Grinding addition on the inner ring raceway
- B** - Cylindrical roller bearings with extended inner ring
- C2** - Radial clearance smaller than normal, bearings with interchangeable elements
- C2NA** - Radial clearance smaller than normal, bearings with non-interchangeable elements
- C3** - Radial clearance larger than normal, bearings with interchangeable elements
- C3NA** - Radial clearance larger than normal, bearings with non-interchangeable elements

- D** - Two-pieces inner ring
- E** - Cylindrical roller bearings, E-design (increased basic static and dynamic loads)
- F** - Machined steel or special cast iron cage
- F2** - Constructive modification
- K** - Tapered bore bearing
- M** - Machined brass cage guided on the rolling elements
- M6** - Machined brass cage with integral rivets
- MA** - Machined brass cage guided in the outer ring
- MA6** - Machined brass cage with internal rivets guided on the outer ring
- MB** - Machined brass cage guided in the inner ring

- MPA** - Machined brass cage (one-piece)
- N** - Circular groove in the outer ring for snap ring
- NA** - Radial clearance, non-interchangeable elements
- NR** - Circular groove in the outer ring and snap ring
- P** - Two-pieces outer ring
- P5** - Tolerance class more accurate than normal (P6)
- P51** - Tolerance class P5 and radial clearance C1
- P53** - Tolerance class P5 and radial clearance C3
- P4** - Tolerance class more accurate than P5
- P41** - Tolerance class P4 and radial clearance C1
- R...** - Non-standardized radial clearance (e.g. R45...85)
- TN** - Polyamide cage
- V** - Roller bearing without cage (full complement)
- VH** - Self-retaining roller bearing without cage
- W20** - Lubrication holes in the outer ring
- W518** - Lubrication holes in the outer and inner ring
- W5** - Lubrication groove and holes in both rings
- W513** - Lubrication groove and holes in the outer ring and lubrication holes in the inner ring
W513 = W33 + W26
- W7** - Locating holes
- W8** - Lubrication groove on the outer ring side surfaces
- W9** - Lubrication groove on the inner ring side surfaces
- W20** - Lubrication holes in the outer ring
- W33** - Lubrication groove and holes on the outer ring
- W44** - Lubrication groove and holes on the Inner ring
- W339** - W9 + W33
- ZS** - NA radial clearance; changing the bearing elements, the clearance can be obtained from the interchangeable elements.

Single or more rows cylindrical roller bearings

Single or more rows cylindrical roller bearings are manufactured by ART in various constructive versions, depending on the position of the ribs on

rings. The four basic designs (NU, NJ, N and NUP) are given in the bearing tables.

Bearings of NU design have two fixed ribs on the outer ring and one smooth inner ring. Bearings of N design have two fixed ribs on the inner ring and one smooth outer ring. These designs allow an axial displacement in certain limits, of the shaft in relation to the housing. Therefore, these rolling bearings are used in non-locating bearing units.

Bearings of NJ design have two fixed ribs on the outer ring and a fixed rib on the inner ring which can guide the shaft in a single direction (axially).

Bearings of NUP design have also two fixed ribs on the outer ring and, on the inner ring, a fixed rib and a support washer. This way they can be used as locating bearings, guiding the shaft axially in both directions.

For a shaft guiding in a single direction, it also can be used a bearing of NU design which is combined with a support washer. Thus, the constructive version NUJ is obtained.

Support washers on both sides of a bearing of NU design are not allowed as they lead to an axial blocking of the rollers.

Cylindrical roller bearings can carry heavy radial loads and can operate at high speeds.

Double or more rows cylindrical roller bearings have small sections, high load carrying capacity and stiffness.

These bearings provide high stiffness and maximum load carrying capacity and are particularly used for tool holders of the machine- tools and rolling mills.

Double row cylindrical roller bearings series NNU49 and NN30 are generally manufactured to tolerance classes P5 and SP, used for machine tools.

Large-sized bearings series NNU49 are also manufactured to the normal tolerance class.

Cylindrical roller bearings with snap ring groove

Single row cylindrical roller bearings are also manufactured with snap ring grooves on the outer

rings. This design simplifies the bearing joint as the bearings are located into the housing by means of the snap rings. The snap ring groove and snap rings are in accordance with ISO 464, and tables 7 and 8 on page 90 and 92.

Cylindrical roller bearings without cage (full complement)

These bearings incorporate the maximum number of rollers and have a small section in relation to their width.

This provides a high load carrying capacity and allows space-saving designs to be achieved.

Cylindrical roller bearings without cage cannot be used at speeds as high as those with cages. These bearings are manufactured with single or more row rollers and suffix V is added to the bearing designation. The most utilized bearings are those of series NCF29 V, NCF30 V and NJ23 VH and they are given in this catalogue on page 210.

Dimensions

The main dimensions of standardized bearings given in tables are in accordance with ISO15.

Misalignment

The modified contact between rollers and raceway allows not only peripheral stresses to be avoided but also, in case of single row roller bearings, permits an angular misalignment of the outer ring with respect to the inner ring, depending on the bearing series and load according to the table 1.

Permissible misalignment Table 1		
Bearings series	Permissible misalignment	
	$P \leq 0,1 C_r$	$P > 0,1 C_r$
NU10, NU2, NU3, NU4, NU2E, NU3E	max. 3'	max. 7'
NU22, NU23, NU22E, NU23E	max. 2'	max. 4'
N,NJ,NUP design, all series	max. 2'	max. 4'

Radial clearance for single and double row cylindrical roller bearings Table 2											
With interchangeable elements With cylindrical bore ¹⁾											
Bore diameter		Clearance group symbol									
d		C2		Normal		C3		C4		C5	
over	up to	min.	max.	min.	max.	min.	max.	min.	max.	min.	max.
mm		μm									
24	30	0	25	20	45	35	60	50	75	65	90
30	40	0	25	20	45	35	60	50	75	70	95
40	50	5	30	25	50	45	70	60	85	80	105
50	65	5	35	30	60	50	80	70	100	95	125
65	80	10	40	40	70	60	90	80	10	110	140
80	100	10	45	40	75	65	100	90	125	130	165
100	120	15	50	50	85	75	110	105	140	155	190
120	140	15	55	50	90	85	125	125	165	180	220
140	160	15	60	60	105	100	145	145	190	200	245
160	180	20	70	70	120	115	165	165	215	225	275
180	200	25	75	75	125	120	170	170	220	250	300
200	225	35	90	90	145	140	195	195	250	275	330
225	250	45	105	105	165	160	220	220	280	305	365
250	280	45	110	110	175	170	235	235	300	330	395
280	315	55	125	125	195	190	260	260	330	370	440
315	355	55	130	130	205	200	275	275	350	410	485
355	400	65	145	145	225	225	305	305	385	455	535
400	450	100	190	190	280	280	370	370	460	510	600
450	500	110	210	210	310	310	410	410	510	565	665
500	550	110	220	220	330	330	440	440	550	625	735
550	600	120	240	240	360	360	480	480	600	660	780
600	650	140	260	260	380	380	500	500	620	675	795
650	710	145	285	285	425	425	565	565	705	765	845
710	800	150	310	310	470	470	630	630	790	790	950
800	900	180	350	350	520	520	690	690	860	860	1030
900	1000	200	390	390	580	580	770	770	960	960	1150
1000	1120	220	430	430	640	640	850	850	1060	1060	1270
1120	1250	230	470	470	710	710	950	950	1190	1190	1430
1250	1400	270	530	530	790	790	1050	1050	1310	1310	1570
1400	1600	330	610	610	890	890	1170	1170	1450	1450	1730

¹⁾ Radial clearance for bearings with tapered bore is staggered with one group to the right, for example radial clearance C3 for cylindrical bore bearing match Normal radial clearance for tapered bore bearings.

Tolerances and radial clearance

Single row cylindrical roller bearings are usually manufactured to normal tolerance class with normal radial clearance. They can also be manufactured to more accurate tolerance classes and with larger (C3NA and C4NA) or smaller (C1NA and C2NA) radial clearances.

Tolerances of cylindrical roller bearings are given on pages 28.

Radial clearances according to international standard ISO 5753 are given in tables 2 and 3 for cylindrical bore bearings both with interchangeable rings and with non-interchangeable rings (NA).

Cages

Small and medium-sized single row cylindrical roller bearings are generally fitted with pressed sheet cages. Large-sized bearings are fitted with machined brass cages of normal design, i.e. cages of separable design guided on rolling elements M, on the outside surface MA or inner surface MB. In case of heavy loads and high speeds, cages are made in one piece.

Glass fiber reinforced polyamide 6.6 cages, are successfully used for small and medium-sized bearings, if the operating temperature doesn't exceed + 120°C. These cages have low mass, low coefficient of friction and are noiseless while running.

Cage design and some technical data are given in table 4.

Radial clearance for single and double row cylindrical roller bearings

Bore diameter		Clearance group symbol											
d		C1NA		C2NA		NA		C3NA		C4NA		C5NA	
over	up to	min.	max.	min.	max.	min.	max.	min.	max.	min.	max.	min.	max.
mm		µm											
2,5	6	0	7	8	15	15	15	30	40	40	50		
6	10	0	7	10	20	20	30	35	45	45	55		
10	14	0	10	10	20	20	30	35	45	45	55		
14	24	5	15	10	20	20	30	35	45	45	55	65	75
24	20	5	15	10	25	25	35	40	50	50	60	70	80
30	40	5	15	12	25	25	40	45	55	55	70	80	95
40	50	5	18	15	30	30	45	50	65	65	80	95	110
50	65	5	20	15	35	35	50	55	75	75	90	110	130
65	80	10	25	20	40	40	60	70	90	90	110	130	150
80	100	10	30	25	45	45	70	80	105	105	125	155	180
100	120	10	30	25	50	50	80	95	120	120	145	180	205
120	140	10	35	30	60	60	90	105	135	135	160	200	230
140	160	10	35	35	65	65	100	115	150	150	180	225	260
160	180	10	40	35	75	75	110	125	165	165	200	250	285
180	200	15	45	40	80	80	120	140	180	180	220	275	315
200	225	15	50	45	90	90	135	155	200	200	240	305	350
225	250	15	50	50	100	100	150	170	215	215	265	330	380
250	280	20	55	55	110	110	165	185	240	240	295	370	420
280	315	20	60	60	120	120	180	205	265	265	325	410	470
315	355	20	65	65	135	135	200	225	295	295	360	455	520
355	400	25	75	75	150	150	225	255	330	330	405	510	585
400	450	25	85	85	170	170	255	285	370	370	455	565	650
450	500	25	95	95	190	190	285	315	410	410	505	625	720
500	560	25	100	105	210	210	315	350	455	455	560	720	815
560	630	30	110	115	230	230	345	390	505	505	620	800	910
630	710	30	130	130	260	260	390	435	565	565	695	900	1030
710	800	35	140	145	290	290	435	485	630	630	775	1000	1140
800	900	35	160	160	320	320	480	540	700	700	860	1130	1290
900	1000	35	180	180	360	360	540	600	780	780	960	1270	1440
1000	1120	50	200	200	400	400	600	660	860	860	1060	1380	1560
1120	1250	60	220	220	440	440	660	730	950	950	1170	1520	1720
1250	1400	60	240	240	480	480	720	810	1050	1050	1290	1680	1900
1400	1600	70	270	270	540	540	810	910	1190	1190	1460	1900	2150

1) Radial clearance for bearings with tapered bore is staggered with one group to the right, for example radial clearance C3NA for cylindrical bore bearings match radial clearance NA for tapered bore bearings.

Minimum load

Cylindrical roller bearings must be subjected to a given minimum load, so that a proper operation of these bearings can be guaranteed.

This is necessary especially as the bearings are operated at high speeds and the centrifugal forces

produce additional friction in bearing due to the sliding between rollers and raceway.

The values of the minimum load can be enough accurately calculated using the equation:

$$F_m = 0,02 C_1, \text{ kN}$$

Cage design and some technical data

Table 4

Cage	Design		Application	Max. value $D_m n$	
	bearing	cage		oil	grease
Pressed sheet cage with fins			<ul style="list-style-type: none"> - General application - Low inertia - Provides proper bearing lubrication - Moderate speeds - Bearings NU, NJ, NUP 	550x10 ³	400x10 ³
Pressed sheet cage with fins			<ul style="list-style-type: none"> - General application - Low inertia - Provides proper bearing lubrication - Moderate speeds - Bearings N 	550x10 ³	400x10 ³
Pressed sheet cage			<ul style="list-style-type: none"> - General application - Low inertia - Provides proper bearing lubrication - Moderate speeds - Bearings construction E type NU, NJ, NUP 	550x10 ³	400x10 ³
Pressed sheet cage with fins			<ul style="list-style-type: none"> - General application - Low inertia - Provides proper bearing lubrication - Moderate speeds - Bearings NU, NJ, NUP 	550x10 ³	400x10 ³
Machined brass cage M, MA, MB			<ul style="list-style-type: none"> - General application - Heavy toads - Moderate and high speeds - Bearings with d > 100 mm 	1200x10 ³	900x10 ³
Machined brass cage M6, MA6			<ul style="list-style-type: none"> - General application - Heavy toads - Moderate and high speeds 	1200x10 ³	900x10 ³
Polyamide cage TN			<ul style="list-style-type: none"> - General application - Low frictional moment - High speeds - Low noise T < 120° C 	1400x10 ³	1100x10 ³
One piece machined brass cage MPA			<ul style="list-style-type: none"> - General application - Heavy toads - Provides proper lubrication - High speeds 	1400x10 ³	1100x10 ³

Equivalent dynamic radial load

For cylindrical roller bearings purely radially loaded which don't locate shafts axially, equivalent dynamic load is:

$$P_r = F_r, \text{ kN}$$

If cylindrical roller bearings have ribs on the outer and inner rings and locate shafts axially in one or both directions, equivalent dynamic load can be calculated using the equations:

$$P_r = F_r, \text{ kN}, \quad \text{when } F_a/F_r \leq e$$

$$P_r = 0,92 F_r + Y F_a, \text{ kN}, \quad \text{when } F_a/F_r > e$$

Where:

- e - calculation factor with values:
 - 0,2 for series 10,2,3 and 4
 - 0,3 for series 22,23
- Y - factor for axial load
 - 0,6 for series 10,2,3 and 4
 - 0,4 for series 22,23

Cylindrical roller bearings axially loaded run satisfactorily only if they are simultaneously radially loaded. Ratio F_a/F_r should not exceed 0,5 for bearings of E design and 0,4 for the other bearings.

Equivalent static radial load

For cylindrical roller bearings purely radially loaded, equivalent static load is:

$$P_{Or} = F_r, \text{ kN}$$

Dynamic axial load

Bearings with ribs on the outer ring can accommodate axial loads in addition to radial loads. The axial load carrying capacity of cylindrical roller bearings do not depend essentially on the steel fatigue strength, but on the resistance of the sliding surfaces at the roller end and rib contact and

therefore on lubrication, operating temperature and bearing thermal conductivity.

Considering the above mentioned, axial load carrying capacity of a cylindrical roller bearing can be enough accurately calculated using the following equation:

$$F_{a \max} = \frac{k_1 C_{Or} 10^4}{n(d+D)} - k_2 F_r,$$

where:

- $F_{a \max}$ - maximum permissible axial load, kN
- C_{Or} - radial static load, kN
- F_r - radial load component, kN
- n - operating speed, r/min
- d - bearing bore diameter, mm
- D - bearing outside diameter, mm
- k_1 - auxiliary factor, see table 5
- k_2 - auxiliary factor, see table 5

The above equation is based on conditions which are considered typical for normal bearing operation:

- a difference of 60°C between the bearing operating temperature and the ambient temperature
- a specific heat loss from the bearing of 0,5 mW/mm² °C
- a viscosity ratio $k=2$.

The viscosity ratio k is the ratio of the actual viscosity at the operating temperature to the requisite viscosity for a proper lubrication at that temperature. Further details can be found in subchapter "Adjusted rating life", life adjustment factor a_{23} - on page 21.

In case of grease lubrication, the base oil viscosity of the grease should be used. These effects can be reduced at low speeds by using oils with EP additives.

Factors k_1 and k_2 Table 5		
Factor	Lubrication	
	oil	grease
Bearings construction E		
k_1	1,5	1
k_2	0,15	0,1
Other bearings		
k_1	0,5	0,3
k_2	0,05	0,03

The values of permissible axial load $F_{a\max}$ obtained from the equation above mentioned are valid for a continuously acting constant axial load. If axial loads act only for short periods, the values may be multiplied by 2 or for shock loads by 3.

The constantly acting axial load $F_{a\max}$ (N) should never exceed the numerical value of $1,2 D^2$ (D = bearing outside diameter, mm) and occasional shock loads should never be greater than the numerical value of $3D^2$.

In case of heavy axial loads ($F_a > D^2$), the ribs of the outer and inner ring respectively are recommended to be supported by the bearing ad joint parts. Bearings of NUP and NJ+HJ designs which take axial loads in both directions are to be placed so that main axial loads should be taken by fixed ribs, if bearing design allows.

Heat treatment

Cylindrical roller bearings with outside diameter $D > 240$ mm of all series given in the catalogue are to be subject to a heat treatment of stress relieving which allows bearings to be operated up to a temperature of $+150^\circ\text{C}$.

The hardness of rigs should not be less 59 HRC.

Small-sized bearings operate normally up to $+120^\circ\text{C}$.

Abutment dimensions

For a proper location of bearing rings on the shaft and housing shoulder respectively, shaft (housing) maximum radius $r_{u\max}$ should be less than bearing minimum mounting chamfer $r_{s\min}$.

Shoulder height should also be properly sized in case of bearing maximum mounting chamfer.

The values of the connection radius and support shoulder height are given in table 6.

Abutment dimensions for single row cylindrical roller bearings are given in table 7. The values for double row cylindrical roller bearings are given in table 8.

Abutment dimensions Table 6				
r_s, r_s min.	r_u max.	h_u min.		
		Bearing series		
		10, 18, 19, 28, 29, 30, 48, 49, 60	2, 2E, 3, 3E, 22, 22E, 23, 23E	4
mm				
0,3	0,3	1	1,2	
0,6	0,6	1,6	2,1	
1	1	2,3	2,8	
1,1	1	3	3,5	4,5
1,5	1,5	3,5	4,5	5,5
2	2	4,4	5,5	6,5
2,1	2,1	5,1	6	7
3	2,5	6,2	7	8
4	3	7,3	8,5	10
5	4	9	10	12
6	5	10	11	

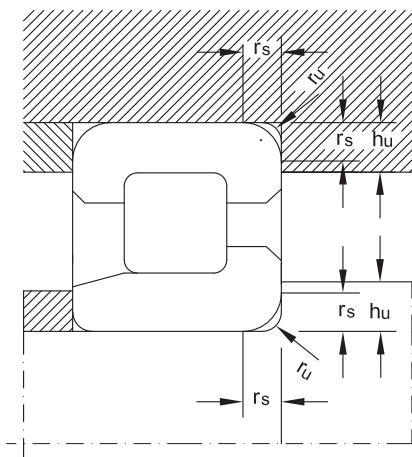

Single row cylindrical roller bearings

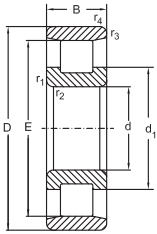

N

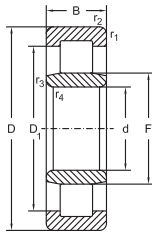

NU

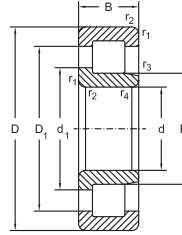

NJ

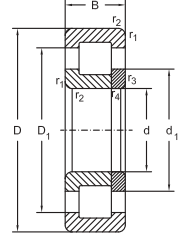

NUP

Dimensions						Basical radial load		Speed limit		Designation
d	D	B	r ₁ , r ₂ min.	r ₃ , r ₄ min.	s ≈	dyn. C _r	stat. C _{0r}	grease	oil	
mm						kN		min ⁻¹		
15	35	11	0,6	0,3	1	12,7	10,4	18000	22000	NU202 E
	35	11	0,6	0,3	-	12,7	10,4	18000	22000	NJ202 E
17	40	12	0,6	0,3	1,2	17,6	14,6	15000	18000	N203
	40	12	0,6	0,3	1,2	17,6	14,6	15000	18000	NU203 E
	40	12	0,6	0,3	-	17,6	14,6	15000	18000	NJ203 E
	40	12	0,6	0,3	-	17,6	14,6	15000	18000	NUP203 E
	40	16	0,6	0,3	1	24	22	15000	18000	NU2203 E
	40	16	0,6	0,3	-	24	22	15000	18000	NJ2203 E
	40	16	0,6	0,3	-	24	22	15000	18000	NUP2203 E
	47	14	1,1	0,6	1,2	16,2	13	13000	16000	NU303 M
47	14	1,1	0,6	-	16,2	13	13000	16000	NJ303 M	
47	14	1,1	0,6	-	16,2	13	13000	16000	NUP303 M	
20	47	14	1	0,6	1	27,5	24,5	13000	16000	N204
	47	14	1	0,6	1	27,5	24,5	13000	16000	NU204 E
	47	14	1	0,6	1	27,5	24,5	13000	16000	NU204 EM6
	47	14	1	0,6	1	27,5	24,5	13000	16000	NU204 ETN
	47	14	1	0,6	-	27,5	24,5	13000	16000	NJ204 E
	47	14	1	0,6	-	27,5	24,5	13000	16000	NJ204 EMA6
	47	14	1	0,6	-	27,5	24,7	13000	16000	NJ204 ETN
	47	14	1	0,6	-	27,5	24,5	13000	16000	NUP204 E
	47	14	1	0,6	-	27,5	24,5	13000	16000	NUP204 EMA6
	47	18	1	0,6	1,8	32,5	31	13000	16000	NU2204 E
	47	18	1	0,6	1,8	32,5	31	13000	16000	NU2204 EMA6
	47	18	1	0,6	-	32,5	31	13000	16000	NJ2204 E
	47	18	1	0,6	-	32,5	31	13000	16000	NJ2204 EMA6
	47	18	1	0,6	-	32,5	31	13000	16000	NUP2204 E
	52	15	1	0,6	1,1	31,5	27	11000	14000	NU304 E
	52	15	1	0,5	1,1	31,5	27	11000	14000	NU304 EMA6
52	15	1	0,6	-	31,5	27	11000	14000	NJ304 E	
52	15	1	0,5	-	31,5	27	11000	14000	NJ304 EM	
52	15	1	0,5	-	31,5	27	11000	14000	NJ304 EMA6	
52	15	1,1	0,6	-	31,5	27	11000	14000	NUP304 E	
52	15	1,1	0,5	-	31,5	27	11000	14000	NUP304 EM	

Single row cylindrical roller bearings

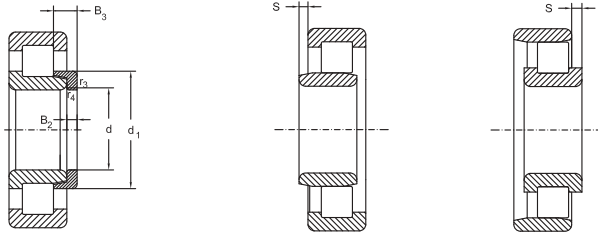

NJ+HJ

d	Dimensions						Thrust collar Designation	Mass	
	E	F	d_1 ≈	D_1 ≈	B_2	B_3		Bearing	Thrust collar
	mm							kg	
15	-	19,3	-	27,8	-	-	-	0,05	-
	-	19,3	21,8	27,8	2,5	5	HJ202 E	0,05	0,007
17	33,9	-	24,7	-	-	-	-	0,07	-
	-	22,1	-	32	-	-	-	0,07	-
	-	22,1	24,7	32	3	5,5	HJ203 E	0,07	0,009
	-	22,1	24,7	32	-	-	-	0,07	-
	-	22,1	-	32	-	-	-	0,09	-
	-	22,1	24,7	32	3	6	HJ2203 E	0,09	0,01
	-	22,1	24,7	32	-	-	-	0,09	-
	-	25,1	-	36,8	-	-	-	0,12	-
20	-	25,1	27,6	36,8	4	6,5	HJ303 E	0,12	0,012
	-	25,1	27,6	36,8	-	-	-	0,12	-
	40	-	29,9	-	-	-	-	0,13	-
	-	26,5	-	38,8	-	-	-	0,13	-
	-	26,5	-	38,3	-	-	-	0,12	-
	-	26,5	-	38,7	-	-	-	0,11	-
	-	26,5	29,9	38,8	3	5,5	HJ204 E	0,13	0,011
	-	26,5	29,9	38,7	3	5	HJ204 E	0,13	0,011
	-	26,5	29,9	38,7	3	5	HJ204 E	0,12	0,011
	-	26,5	29,9	38,8	-	-	-	0,13	-
	-	26,5	29,9	38,7	-	-	-	0,15	-
	-	26,5	-	38,4	-	-	-	0,14	-
	-	26,5	-	38,7	-	-	-	0,16	-
	-	26,5	29,9	38,4	3	6,5	HJ2204 E	0,14	0,012
	-	26,5	29,7	38,7	3	6,5	HJ2204 E	0,17	-
	-	26,5	29,9	38,4	-	-	-	0,14	-
	-	27,5	-	41,8	-	-	-	0,15	-
	-	27,5	-	42,4	-	-	-	0,18	-
-	27,5	31,4	41,8	4	6,5	HJ304 E	0,15	0,017	
-	28,5	32	42	4	6,5	HJ304 E	0,17	0,017	
-	27,5	31	42,4	4	6,5	HJ304 E	0,18	0,017	
-	27,5	31,4	41,8	-	-	-	0,15	-	
-	27,5	31	42	-	-	-	0,17	-	

Single row cylindrical roller bearings

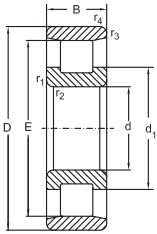

N

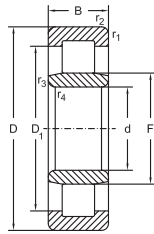

NU

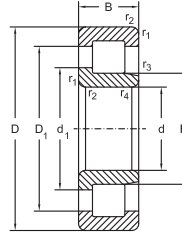

NJ

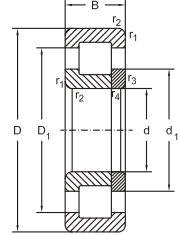

NUP

Dimensions						Basical radial load		Speed limit		Designation
d	D	B	r ₁ , r ₂ min.	r ₃ , r ₄ min.	s ≈	dyn. C _r	stat. C _{10r}	grease	oil	
mm						kN		min ⁻¹		
20	52	15	1,1	0,5	-	31,5	27	11000	14000	NUP304 EMA6
	52	21	1,1	0,6	2	41,5	39	11000	14000	NU2304 E
	52	21	1,1	0,6	2	41,5	39	11000	14000	NU2304 EM
	52	21	1,1	0,6	-	41,5	39	11000	14000	NJ2304 E
	52	21	1,1	0,6	-	41,5	39	11000	14000	NJ2304 EM
	52	21	1,1	0,6	-	41,5	39	11000	14000	NUP2304 E
25	52	21	1,1	0,6	-	41,5	39	11000	14000	NUP2304 EM
	52	15	1	0,6	1,3	29	27,5	12000	15000	N205
	52	15	1	0,6	1,3	29	27,5	12000	15000	NU205 E
	52	15	1	0,6	1,3	29	27,5	12000	15000	NU205 EM6
	52	15	1	0,6	1,3	31	29,7	12000	15000	NU205 ETN
	52	15	1	0,6	-	29	27,5	12000	15000	NJ205 E
	52	15	1	0,6	-	29	27,5	12000	15000	NJ205 EM6
	52	15	1	0,6	-	29	27,5	12000	15000	NUP205 E
	52	15	1	0,6	-	29	27,5	12000	15000	NUP205 EM6
	52	18	1	0,6	1,7	34,5	35	12000	15000	NU2205 E
	52	18	1	0,6	1,7	34,5	35	12000	15000	NU2205 EM6
	52	18	1	0,6	-	34,5	35	12000	15000	NJ2205 E
	52	18	1	0,6	-	34,5	35	12000	15000	NJ2205 EM6
	52	18	1	0,6	-	34,9	34,6	12000	15000	NJ2205 ETN
	52	18	1	0,6	-	34,5	35	12000	15000	NUP2205 E
	52	18	1	0,6	-	34,5	35	12000	15000	NUP2205 EM6
	62	17	1,1	1,1	1,3	41,5	37,5	9500	12000	N305
	62	17	1,1	1,1	1,3	41,5	37,5	9500	12000	NU305 E
	62	17	1,1	1,1	1,3	41,5	37,5	9500	12000	NU305 EM
	62	17	1,1	1,1	-	41,5	37,5	9500	12000	NJ305 E
	62	17	1,1	1,1	-	41,5	37,5	9500	12000	NJ305 EM
62	17	1,1	1,1	-	41,6	37,4	9500	12000	NJ305 ETN	
62	17	1,1	1,1	-	41,5	37,5	9500	12000	NUP305 E	
62	17	1,1	1,1	-	41,5	37,5	9500	12000	NUP305 EM	
62	24	1,1	1,1	1,9	57	56	9500	12000	NU2305 E	
62	24	1,1	1,1	-	57	56	9500	12000	NJ2305 E	
62	24	1,1	1,1	-	57	56	9500	12000	NJ2305 EM	

Single row cylindrical roller bearings

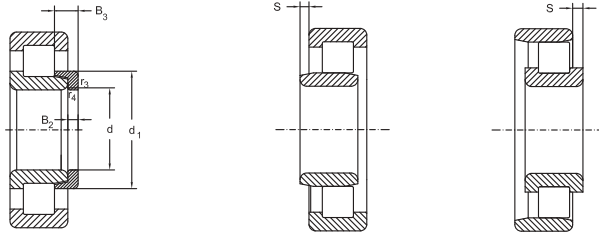

NJ+HJ

d	E	Dimensions					Thrust collar Designation	Mass	
		F	d_1 ≈	D_1 ≈	B_2	B_3		Bearing	Thrust collar
		mm							
20	-	27,5	31	42,4	-	-	-	0,18	-
	-	27,5	-	41,8	-	-	-	0,21	-
	-	27,5	-	42	-	-	-	0,25	-
	-	27,5	31,4	41,8	4	7,5	HJ2304 E	0,21	0,019
	-	27,5	31,5	42	4	7,5	HJ2304 E	0,25	0,019
	-	27,5	31,4	41,8	-	-	-	0,21	-
25	-	27,5	31,5	42	-	-	-	0,33	-
	45	-	35	-	-	-	-	0,13	-
	-	31,5	-	43,3	-	-	-	0,14	-
	-	31,5	-	43,6	-	-	-	0,15	-
	-	31,5	-	44	-	-	-	0,13	-
	-	31,5	34,9	43,3	3	6	HJ2205 E	0,14	0,015
	-	31,5	34,9	42	3	6	HJ2205 E	0,16	0,015
	-	31,5	34,9	43,3	-	-	-	0,14	-
	-	31,5	34,9	42	-	-	-	0,16	-
	-	31,5	-	43,3	-	-	-	0,16	-
	-	31,5	-	43,6	-	-	-	0,19	-
	-	31,5	34,9	43,3	3	6,5	HJ2205 E	0,16	0,015
	-	31,5	34,1	43,6	3	6,5	HJ2205 E	0,19	0,015
	-	31,5	34,1	43,6	3	6,5	HJ2205 E	0,17	0,015
	-	31,5	34,9	43,3	-	-	-	0,16	-
	-	31,5	34,1	43,6	-	-	-	0,20	-
	53	-	39	-	-	-	-	0,25	-
	-	34	-	50,1	-	-	-	0,25	-
	-	34	-	50,5	-	-	-	0,29	-
	-	34	38,3	50,1	4	7	HJ305 E	0,25	0,025
-	34	37,5	50,5	4	7	HJ305 E	0,29	0,025	
-	34	37,5	50,5	4	7	HJ305 E	0,24	0,025	
-	34	38,3	50,1	-	-	-	0,25	-	
-	34	37,5	50,5	-	-	-	0,30	-	
-	34	-	50,1	-	-	-	0,35	-	
-	34	38,3	50,1	4	8	HJ2305 E	0,35	0,027	
-	34	38,2	50,5	4	8	HJ2305 E	0,41	0,027	

Single row cylindrical roller bearings

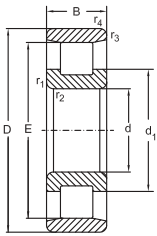

N

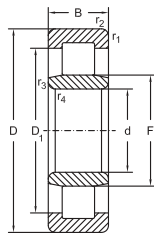

NU

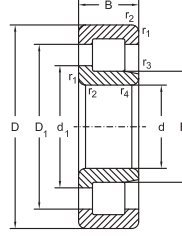

NJ

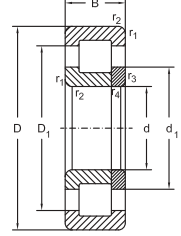

NUP

d	Dimensions					Basical radial load		Speed limit		Designation
	D	B	r_1, r_2 min.	r_3, r_4 min.	s ≈	dyn. C_r	stat. C_{10}	grease	oil	
mm						kN		min^{-1}		
25	62	24	1,1	1,1	-	57	56	9500	12000	NUP2305 E
	80	21	1,5	1,5	2,2	50,6	44,4	8500	10000	NU405 M
	80	21	1,5	1,5	-	50,6	44,4	8500	10000	NJ405 M
	80	21	1,5	1,5	-	50,6	44,4	8500	10000	NUP405 M
30	62	16	1	0,6	1,4	39,7	37,9	9500	12000	N206 EM6
	62	16	1	0,6	1,4	39,7	37,9	9500	12000	NU206 E
	62	16	1	0,6	1,4	39,7	37,9	9500	12000	NU206 EM6
	62	16	1	0,6	1,4	41,3	40,2	9500	12000	NU206 ETN
	62	16	1	0,6	-	39,7	37,9	9500	12000	NJ206 E
	62	16	1	1	-	39,7	37,9	9500	12000	NJ206 EM6
	62	16	1	1	-	39,7	37,9	9500	12000	NJ206 ETN
	62	16	1	0,6	-	39,7	37,9	9500	12000	NUP206 E
	62	16	1	1	-	39,7	37,9	9500	12000	NUP206 EM6
	62	20	1	0,6	1,6	49	50	9500	12000	NU2206 E
	62	20	1,5	1	1,6	49	50	9500	12000	NU2206 EMA6
	62	20	1	0,6	1,6	52	54	9500	12000	NU2206 ETN
	62	20	1	0,6	-	49	50	9500	12000	NJ2206 E
	62	20	1	0,6	-	49	50	9500	12000	NJ2206 EMA6
	62	20	1	0,6	-	52	54	9500	12000	NJ2206 ETN
	62	20	1	0,6	-	49	50	9500	12000	NUP2206 E
	72	19	1,1	1,1	1,9	51	48	8500	10000	N306
	72	19	1,1	1,1	1,9	51,2	48	8500	10000	NU306 E
	72	19	1,1	1,1	1,9	51,2	48	8500	10000	NU306 EM
	72	19	1,1	1,1	1,9	51,2	48	8500	10000	NU306 ETN
	72	19	1,1	1,1	-	51,2	48	8500	10000	NJ306 E
	72	19	1,1	1,1	-	51,2	48	8500	10000	NJ306 EM
	72	19	1,1	1,1	-	51,2	48	8500	10000	NJ306 ETN
	72	19	1,1	1,1	-	51,2	48	8500	10000	NUP306 E
72	19	1,1	1,1	-	51,2	48	8500	10000	NUP306 EM	
72	27	1,1	1,1	2,5	73,5	75	8500	10000	NU2306 E	
72	27	1,1	1,1	-	73,5	75	8500	10000	NJ2306 E	
72	27	1,1	1,1	-	73,5	75	8500	10000	NJ2306 EM	
72	27	1,1	1,1	-	73,5	75	8500	10000	NUP2306 E	

Single row cylindrical roller bearings

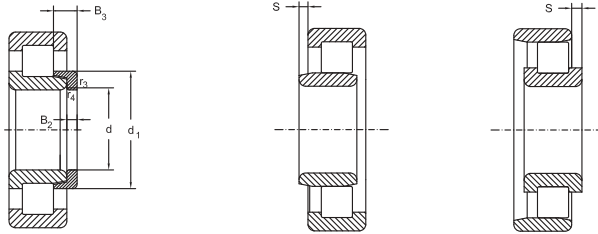

NJ+HJ

d	Dimensions						Thrust collar Designation	Mass	
	E	F	d_1 ≈	D_1 ≈	B_2	B_3		Bearing	Thrust collar
	mm							kg	
25	-	34	38,3	50,1	-	-	-	0,35	-
	-	38,8	-	58,4	-	-	-	0,63	-
	-	38,8	43,6	58,4	6	10,5	HJ405	0,63	0,057
	-	38,8	43,4	57,5	-	-	-	0,65	-
30	55,5	-	41,4	-	-	-	-	0,21	-
	-	37,5	-	52	-	-	-	0,21	-
	-	37,5	-	52,5	-	-	-	0,24	-
	-	37,5	-	52,5	-	-	-	0,20	-
	-	37,5	41,4	52	4	7	HJ206 E	0,21	0,025
	-	37,5	40,7	50	4	7	HJ206 E	0,24	0,025
	-	37,5	40,7	52,5	4	7	HJ206 E	0,20	0,025
	-	37,5	41,4	52	-	-	-	0,21	-
	-	37,5	40,7	52,5	-	-	-	0,25	-
	-	37,5	-	52	-	-	-	0,26	-
	-	37,5	-	52,25	-	-	-	0,31	-
	-	37,5	-	52,25	-	-	-	0,26	-
	-	37,5	41,4	52	4	7,5	HJ2206 E	0,26	0,025
	-	37,5	40,7	52,25	4	7,5	HJ2206 E	0,31	0,025
	-	37,5	40,7	52,25	4	7,5	HJ2206 E	0,26	0,025
	-	37,5	41,4	52	-	-	-	0,26	-
	62	-	46,4	-	-	-	-	0,36	-
	-	40,5	-	58,3	-	-	-	0,37	-
	-	40,5	-	58,5	-	-	-	0,43	-
	-	40,5	-	58,5	-	-	-	0,38	-
	-	40,5	45,1	58,3	5	8,5	HJ306 E	0,37	0,043
	-	40,5	44,2	57,6	5	8,5	HJ306 E	0,45	0,043
-	40,5	44,2	57,6	5	8,5	HJ306 E	0,39	0,043	
-	40,5	45,1	58,3	-	-	-	0,37	-	
-	42	46,3	58,2	-	-	-	0,45	-	
-	40,5	-	58,3	-	-	-	0,53	-	
-	40,5	45,1	58,3	5	9,5	HJ2306 E	0,53	0,045	
-	40,5	44,2	58,6	5	9,5	HJ2306 E	0,63	0,045	
-	40,5	45,1	58,3	-	-	-	0,53	-	

Single row cylindrical roller bearings

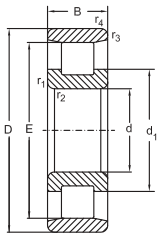

N

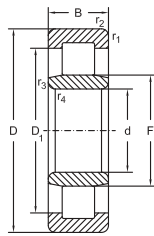

NU

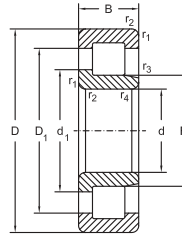

NJ

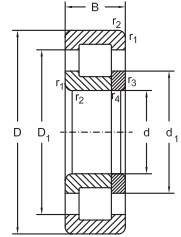

NUP

d	Dimensions					Basical radial load		Speed limit		Designation
	D	B	$r_{1,2}$ min.	$r_{3,4}$ min.	s ≈	dyn. C _r	stat. C _{0r}	grease	oil	
mm						kN		min ⁻¹		
30	90	23	1,5	1,5	2,3	65	57,8	7000	8500	N406 M
	90	23	1,5	1,5	2,3	65	57,8	7000	8500	NU406 M
	90	23	1,5	1,5	-	65	57,8	7000	8500	NJ406 M
	90	23	1,5	1,5	-	65	57,8	7000	8500	NUP406 M
35	62	14	1	0,6	1	23,6	24,5	10000	13000	NU1007 M
	72	17	1,1	0,6	1,7	50	50	8500	10000	N207
	72	17	1,1	0,6	1,7	50	50	8500	10000	NU207 E
	72	17	1,1	0,6	1,7	50	50	8500	10000	NU207 EM
	72	17	1,1	0,6	1,7	53	54	8500	10000	NU207 ETN
	72	17	1,1	0,6	-	50	50	8500	10000	NJ207 E
	72	17	1,1	0,6	-	53	54	8500	10000	NJ207 ETN
	72	17	1,1	0,6	-	50	50	8500	10000	NUP207 E
	72	17	1,1	0,6	-	50	50	8500	10000	NUP207 EM
	72	17	1,1	0,6	-	53	54	8500	10000	NUP207 ETN
	72	23	1,1	0,6	2,9	65	70	8500	10000	N2207
	72	23	1,1	0,6	2,9	65	70	8500	10000	NU2207 E
	72	23	1	0,6	-	65	70	8500	10000	NJ2207 E
	72	23	1	0,6	-	65	70	8500	10000	NUP2207 E
	80	21	1,1	1,5	0,6	66,7	65,4	7500	9000	N307
	80	21	1,1	1,5	0,6	66,7	65,4	7500	9000	NU307 E
	80	21	1,5	1,1	0,6	66,7	65,4	7500	9000	NU307 EM
	80	21	1,1	1,5	-	66,7	65,4	7500	9000	NJ307 E
	80	21	1,5	1,1	-	66,7	65,4	7500	9000	NJ307 M
	80	21	1,1	1,5	-	66,7	65,4	7500	9000	NUP307 E
80	21	1,5	1,1	-	66,7	65,4	7500	9000	NUP307 EM	
80	31	1,1	1,5	3	91,5	98	7500	9000	NU2307 E	
80	31	1,1	1,5	-	91,5	98	7500	9000	NJ2307 E	
80	31	1,5	1,1	-	91,5	98	7500	9000	NJ2307 EM	
80	31	1,1	1,5	-	91,5	98	7500	9000	NUP2307 E	
100	25	1,5	1,5	2,6	75	69,5	6300	7500	N407 M	
100	25	1,5	1,5	2,6	75	69,5	6300	7500	NU407 M	
100	25	1,5	1,5	-	75	69,5	6300	7500	NJ407 M	
100	25	1,5	1,5	-	75	69,5	6300	7500	NUP407 M	

Single row cylindrical roller bearings

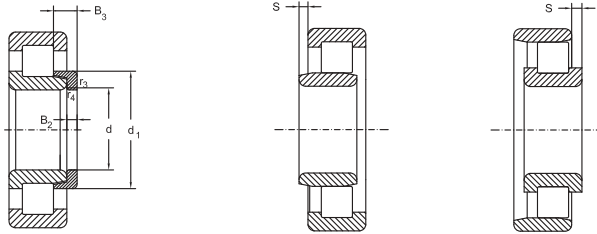

NJ+HJ

d	E	Dimensions					Thrust collar Designation	Mass	
		F	d_1 ≈	D_1 ≈	B_2	B_3		Bearing	Thrust collar
mm							kg		
30	73	-	50,5	-	-	-	-	0,87	-
	-	45	-	67,8	-	-	-	0,87	-
	-	45	50,5	67,8	7	11,5	HJ406	0,87	0,09
	-	45	50,5	67,8	-	-	-	0,87	-
35	-	42	44,5	51,9	4	7,75	HJ1007	0,18	0,02
	61,8	-	47,6	-	-	-	-	0,31	-
	-	44	-	60,1	-	-	-	0,31	-
	-	44	-	60,4	-	-	-	0,33	-
	-	44	-	60,4	-	-	-	0,31	-
	-	44	48	60,1	4	7	HJ207 E	0,31	0,033
	-	44	47,5	60,4	4	7	HJ207 E	0,32	0,033
	-	44	48	60,1	-	-	-	0,31	-
	-	44	47,5	60,4	-	-	-	0,34	-
	-	44	47,5	60,4	-	-	-	0,32	-
	61,8	-	47,6	-	-	-	-	0,38	-
	-	44	-	60,1	-	-	-	0,40	-
	-	44	48	60,1	4	8,5	HJ2207 E	0,40	0,035
	-	44	48	60,1	-	-	-	0,40	-
	68,2	-	51	-	-	-	-	0,47	-
	-	46,2	-	65,7	-	-	-	0,49	-
	-	46,2	-	66,2	-	-	-	0,56	-
	-	46,2	51,2	65,7	6	9,5	HJ307 E	0,49	0,062
	-	46,2	50,5	63,4	6	9,5	HJ307 E	0,54	0,065
	-	46,2	51,2	65,7	-	-	-	0,49	-
-	46,2	50,5	66,2	-	-	-	0,55	-	
-	46,2	-	65,7	-	-	-	0,72	-	
-	46,2	51,2	65,7	6	11	HJ2307 E	0,72	0,065	
-	46,2	50,3	66,3	6	11	HJ2307 E	0,84	0,065	
-	46,2	51,2	65,7	-	-	-	0,72	-	
83	-	59	-	-	-	-	1,05	-	
-	53	-	77,6	-	-	-	1,05	-	
-	53	59	77,6	8	13	HJ407	1,05	0,13	
-	53	59	77,6	-	-	-	1,05	-	

Single row cylindrical roller bearings

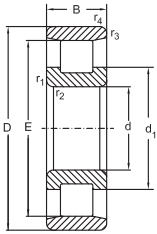

N

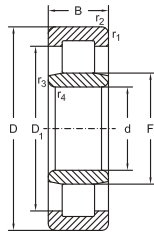

NU

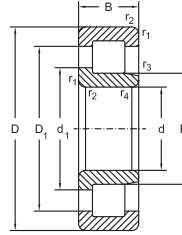

NJ

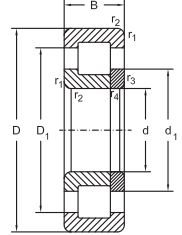

NUP

Dimensions						Basical radial load		Speed limit		Designation
d	D	B	r_1, r_2 min.	r_3, r_4 min.	s ≈	dyn. C_r	stat. C_{10}	grease	oil	
mm						kN		min^{-1}		
40	68	15	1	0,6	-	26,1	27,3	9500	12000	NJ1008 M
	68	15	1,1	0,6	2,4	26,1	27,3	9500	12000	NU1008 M
	80	18	1,1	1,1	1,9	53	53	7500	9000	N208
	80	18	1,1	1,1	1,9	53,9	53	7500	9000	NU208 E
	80	18	1,1	1,1	1,9	53,9	53	7500	9000	NU208 EM
	80	18	1,1	1,1	1,9	53,9	53	7500	9000	NU208 ETN
	80	18	1,1	1,1	-	53,9	53	7500	9000	NJ208 E
	80	18	1,1	1,1	-	53,9	53	7500	9000	NJ208 EM
	80	18	1,1	1,1	-	53,9	53	7500	9000	NJ208 ETN
	80	18	1,1	1,1	-	53,9	53	7500	9000	NUP208 E
	80	18	1,1	1,1	-	53,9	53	7500	9000	NUP208 EM
	80	18	1,1	1,1	-	53,9	53	7500	9000	NUP208 ETN
	80	23	1,1	1,1	2,3	71	75	7500	9000	NJ2208 E
	80	23	1,1	1,1	-	71	75	7500	9000	NU2208 E
	80	23	1,1	1,1	-	73,6	79,6	7500	9000	NJ2208 ETN
	80	23	1,1	1,1	-	71	75	7500	9000	NUP2208 E
	90	23	1,5	1,5	1,5	81,5	78	6300	7500	N308
	90	23	1,5	1,5	1,5	81,5	78	6300	7500	NU308 E
	90	23	1,5	1,5	1,5	81,5	78	6300	7500	NU308 EM
	90	23	1,5	1,5	1,5	85,3	84,5	6300	7500	NU308 ETN
	90	23	1,5	1,5	-	81,5	78	6300	7500	NJ308 E
	90	23	1,5	1,5	-	81,5	78	6300	7500	NJ308 EM
	90	23	1,5	1,5	-	85,3	84,5	6300	7500	NJ308 ETN
	90	23	1,5	1,5	-	81,5	78	6300	7500	NUP308 E
	90	23	1,5	1,5	-	81,5	78	6300	7500	NUP308 EM
	90	33	1,5	1,5	3	112	120	6300	7500	NU2308 E
	90	33	1,5	1,5	3	112	120	6300	7500	NU2308 EM
	90	33	1,5	1,5	-	112	120	6300	7500	NJ2308 E
90	33	1,5	1,5	-	112	120	6300	7500	NJ2308 EM	
90	33	1,5	1,5	-	112	120	6300	7500	NUP2308 E	
90	33	1,5	1,5	-	112	120	6300	7500	NUP2308 EM	
110	27	2	2	2,6	93	86,5	5500	6800	N408 M	
110	27	2	2	2,6	93	86,5	5500	6800	NU408 M	

Single row cylindrical roller bearings

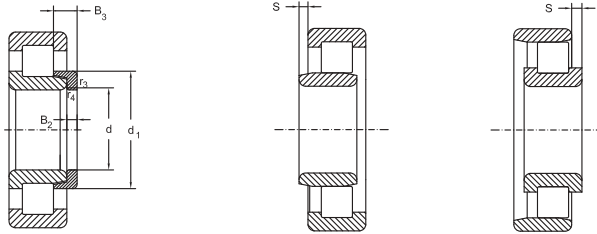

NJ+HJ

d	E	Dimensions					Thrust collar Designation	Mass	
		F	d_1 ≈	D_1 ≈	B_2	B_3		Bearing	Thrust collar
		mm							kg
40	-	47	50	57,6	4	8	HJ1008	0,23	0,03
	-	47	-	57,7	-	-	-	0,23	-
	70	-	54,4	-	-	-	-	0,40	-
	-	49,5	-	67,3	-	-	-	0,38	-
	-	49,5	-	67,5	-	-	-	0,44	-
	-	49,5	-	67,5	-	-	-	0,39	-
	-	49,5	54,1	67,3	5	8,5	HJ208 E	0,38	0,05
	-	50	54,4	67,5	5	8,5	HJ208 E	0,45	0,05
	-	49,5	53,2	67,5	5	8,5	HJ208 E	0,40	0,05
	-	49,5	54,1	67,3	-	-	-	0,38	-
	-	50	54,4	65,5	-	-	-	0,46	-
	-	50	54,4	67,5	-	-	-	0,41	-
	-	49,5	-	67,3	-	-	-	0,49	-
	-	49,5	54,1	67,3	5	9	HJ2208 E	0,49	0,05
	-	49,5	53,2	67,5	5	9	HJ2208 E	0,51	0,05
	-	49,5	54,1	67,3	-	-	-	0,49	-
	77,5	-	58,8	-	-	-	-	0,66	-
	-	52	-	74,9	-	-	-	0,65	-
	-	52	-	75	-	-	-	0,73	-
	-	52	-	75	-	-	-	0,66	-
	-	52	57,7	74,9	7	-	HJ308 E	0,66	0,088
	-	52	56,9	75	7	11	HJ308 E	0,75	0,088
	-	52	56,9	75	7	11	HJ308 E	0,67	0,088
	-	52	57,7	74,9	-	-	-	0,66	-
	-	52	56,9	75	-	-	-	0,70	-
	-	52	-	74,9	-	-	-	0,95	-
	-	52	-	75,4	-	-	-	1,24	-
	-	52	57,7	74,9	7	12,5	HJ2308 E	0,95	0,92
	-	52	56,9	75,4	7	12,5	HJ2308 E	1,02	0,92
	-	52	57,7	74,9	-	-	-	0,95	-
-	52	56,9	75,4	-	-	-	1,27	-	
92	-	64,8	-	-	-	-	1,30	-	
-	58	-	85,8	-	-	-	1,30	-	

Single row cylindrical roller bearings

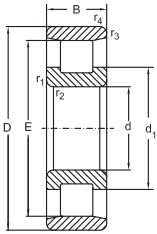

N

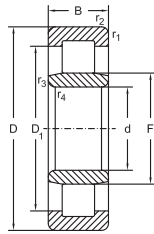

NU

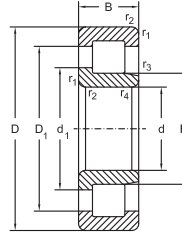

NJ

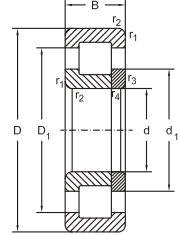

NUP

Dimensions						Basical radial load		Speed limit		Designation
d	D	B	r_1, r_2 min.	r_3, r_4 min.	s ≈	dyn. C_r	stat. C_{10}	grease	oil	
mm						kN		min^{-1}		
40	110	27	2	2	-	93	86,5	5500	6800	NJ408 M
	110	27	2	2	-	93	86,5	5500	6800	NUP408 M
45	75	16	1	0,6	2,5	32,5	35,5	8500	10000	NU1009 M
	85	19	1,1	1,1	1,9	61	63	7000	8500	N209 E
	85	19	1,1	1,1	1,9	61	63	7000	8500	NU209 E
	85	19	1,1	1,1	1,9	61	63	7000	8500	NU209 EM
	85	19	1,1	1,1	1,9	63,2	67	7000	8500	NU209 ETN
	85	19	1,1	1,1	-	61	63	7000	8500	NJ209 E
	85	19	1,1	1,1	-	61	63	7000	8500	NJ209 EM
	85	19	1,1	1,1	-	61	63	7000	8500	NUP209 E
	85	19	1,1	1,1	-	61	63	7000	8500	NUP209 EM
	85	23	1,1	1,1	2,3	76	81,6	7000	8500	NU2209 E
	85	23	1,1	1,1	2,3	76	81,6	7000	8500	NU2209 EM
	85	23	1,1	1,1	-	76	81,6	7000	8500	NJ2209 E
	85	23	1,1	1,1	-	76	81,6	7000	8500	NJ2209 EM
	85	23	1,1	1,1	-	76	81,6	7000	8500	NUP2209 E
	100	25	1,5	1,5	2,9	98	100	5600	6700	N309 E
	100	25	1,5	1,5	2,9	98	100	5600	6700	NU309 E
	100	25	1,5	1,5	2,9	98	100	5600	6700	NU309 EM
	100	25	1,5	1,5	-	98	100	5600	6700	NJ309 E
100	25	1,5	1,5	-	98	100	5600	6700	NJ309 EM	
100	25	1,5	1,5	-	98	100	5600	6700	NUP309 E	
100	25	1,5	1,5	-	98	100	5600	6700	NUP309 EM	
100	36	1,5	1,5	3,5	137	153	5600	6700	NU2309 E	
100	36	1,5	1,5	3,5	137	153	5600	6700	NU2309 EM	
100	36	1,5	1,5	-	137	153	5600	6700	NJ2309 E	
100	36	1,5	1,5	-	137	153	5600	6700	NJ2309 EM	
100	36	1,5	1,5	-	137	153	5600	6700	NUP2309 E	
100	36	1,5	1,5	-	137	153	5600	6700	NUP2309 EM	
120	29	2	2	2,9	113	109	5000	6000	N409 M	
120	29	2	2	2,9	113	109	5000	6000	NU409 M	
120	29	2	2	-	113	109	5000	6000	NJ409 M	
120	29	2	2	-	113	109	5000	6000	NUP409 M	

Single row cylindrical roller bearings

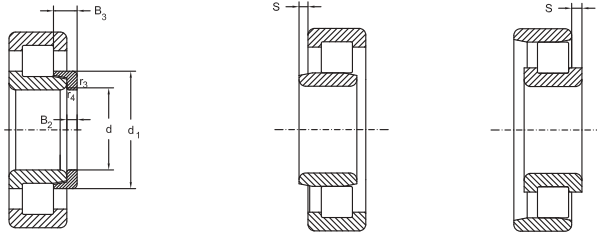

NJ+HJ

d	Dimensions						Thrust collar Designation	Mass	
	E	F	d_1 ≈	D_1 ≈	B_2	B_3		Bearing	Thrust collar
	mm							kg	
40	-	58	64,8	85,8	8	13	HJ408	1,30	0,15
	-	58	64,8	85,8	-	-	-	1,30	-
	-	52,5	55,5	63,9	-	-	-	0,29	-
	76,5	-	59,1	-	-	-	-	0,50	-
	-	54,5	-	72,4	-	-	-	0,50	-
	-	54,5	-	72,5	-	-	-	0,50	-
	-	54,5	-	72,5	-	-	-	0,44	-
	-	54,5	59,1	72,4	5	8,5	HJ209 E	0,50	0,05
	-	54,5	58,4	72,5	5	8,5	HJ209 E	0,50	0,05
	-	54,5	59,1	72,4	-	-	-	0,50	-
45	-	54,5	58,4	72,5	-	-	-	0,51	-
	-	54,5	-	72,4	-	-	-	0,60	-
	-	54,5	-	72,6	-	-	-	0,59	-
	-	54,5	59,1	72,4	5	9	HJ2209 E	0,60	0,057
	-	54,5	58,4	72,6	5	9	HJ2209 E	0,58	0,057
	-	54,5	59,1	72,4	-	-	-	0,60	-
	88,5	-	64,6	-	-	-	-	1	-
	-	58,5	-	83,1	-	-	-	1	-
	-	58,5	-	83,2	-	-	-	1	-
	-	58,5	64,6	83,1	7	11,5	HJ309 E	1	0,11
	-	58,5	63,8	83,2	7	13	HJ309 E	1,02	0,11
	-	58,5	64,6	83,1	-	-	-	1	-
	-	58,5	63,8	83,2	-	-	-	1,03	-
	-	58,5	-	83,1	-	-	-	1,30	-
	-	58,5	-	83,5	-	-	-	1,44	-
	-	58,5	64,6	83,1	7	13	HJ2309 E	1,30	0,12
	-	58,5	63,8	83,5	7	13	HJ2309 E	1,43	0,12
	-	58,5	64,6	83,1	-	-	-	1,30	-
-	58,5	63,8	83,5	-	-	-	1,49	-	
100,5	-	71,8	-	-	-	-	1,70	-	
-	64,5	-	93,9	-	-	-	1,70	-	
-	64,5	71,8	93,9	8	13,5	HJ409	1,70	0,19	
-	64,5	71,8	93,9	-	-	-	1,70	-	

Single row cylindrical roller bearings

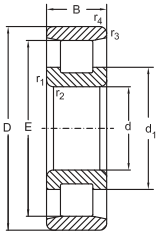

N

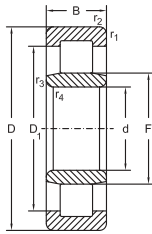

NU

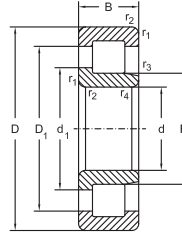

NJ

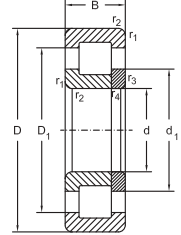

NUP

Dimensions						Basical radial load		Speed limit		Designation
d	D	B	r_1, r_2 min.	r_3, r_4 min.	s ≈	dyn. C_r	stat. C_{10}	grease	oil	
mm						kN		min^{-1}		
50	80	16	1	0,6	2,5	36	41,5	8000	9500	NU1010 M
	90	20	1,1	1,1	2,2	64,4	68	6700	8000	N210 E
	90	20	1,1	1,1	2,2	64,4	68	6700	8000	NU210 E
	90	20	1,1	1,1	2,2	64,4	68	6700	8000	NU210 EM
	90	20	1,1	1,1	-	64,4	72,2	6700	8000	NJ210 ETN
	90	20	1,1	1,1	-	64,4	68	6700	8000	NJ210 EM
	90	20	1,1	1,1	-	64,4	68	6700	8000	NJ210 E
	90	20	1,1	1,1	-	64,4	68	6700	8000	NUP210 E
	90	20	1,1	1,1	-	64,4	68	6700	8000	NUP210 EM
	90	23	1,1	1,1	2,2	78	88	6700	8000	NU2210 E
	90	23	1,1	1,1	2,2	78	88	6700	8000	NU2210 EM
	90	23	1,1	1,1	-	78	88	6700	8000	NJ2210 E
	90	23	1,1	1,1	-	78	88	6700	8000	NJ2210 EM
	90	23	1,1	1,1	-	78	88	6700	8000	NUP2210 E
	90	23	1,1	1,1	-	78	88	6700	8000	NUP2210 EM
	110	27	2	2	3	110	114	5300	6300	N310 E
	110	27	2	2	3	110	114	5300	6300	NU310 E
	110	27	2	2	3	110	114	5300	6300	NU310 EM
	110	27	2	2	3	110	114	5300	6300	NU310 ETN
	110	27	2	2	-	110	114	5300	6300	NJ310 E
	110	27	2	2	-	110	114	5300	6300	NJ310 EM
	110	27	2	2	-	110	114	5300	6300	NJ310 ETN
	110	27	2	2	-	110	114	5300	6300	NUP310 E
	110	27	2	2	-	110	114	5300	6300	NUP310 EM
110	40	2	2	3,7	163	186	5300	6300	NU2310 E	
110	40	2	2	3,7	163	186	5300	6300	NU2310 EM	
110	40	2	2	-	163	186	5300	6300	NJ2310 E	
110	40	2	2	-	163	186	5300	6300	NJ2310 EM	
110	40	2	2	-	163	186	5300	6300	NUP2310 E	
110	40	2	2	-	163	186	5300	6300	NUP2310 EM	
130	31	2,1	2,1	3	139	136	4500	5300	N410 M	
130	31	2,1	2,1	3	139	136	4500	5300	NU410 M	
130	31	2,1	2,1	-	139	136	4500	5300	NJ410 M	
130	31	2,1	2,1	-	139	136	4500	5300	NUP410 M	

Single row cylindrical roller bearings

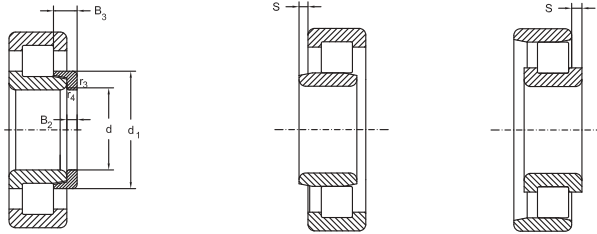

NJ+HJ

d	Dimensions						Thrust collar Designation	Mass	
	E	F	d_1 ≈	D_1 ≈	B_2	B_3		Bearing	Thrust collar
	mm							kg	
50	-	57,5	60,5	68,9	-	-	-	0,32	-
	81,5	-	64,1	-	-	-	-	0,60	-
	-	59,5	-	77,4	-	-	-	0,60	-
	-	59,5	-	77,5	-	-	-	0,52	-
	-	59,5	63,2	77,5	5	9	HJ210 E	0,51	0,06
	-	59,5	63,2	77,5	5	9	HJ210 E	0,53	0,06
	-	59,5	64,1	77,4	5	9	HJ210 E	0,60	0,06
	-	59,5	64,1	77,4	-	-	-	0,60	-
	-	59,5	63,2	77,5	-	-	-	0,59	-
	-	59,5	-	77,4	-	-	-	0,65	-
	-	59,5	-	77,6	-	-	-	0,66	-
	-	59,5	64,1	77,4	5	9	HJ2210 E	0,65	0,06
	-	59,5	63,2	77,6	5	9	HJ2210 E	0,67	0,06
	-	59,5	64,1	77,4	-	-	-	0,65	-
	97	-	71,4	-	-	-	-	1,20	-
	-	65	-	91,4	-	-	-	1,20	-
	-	65	-	91,5	-	-	-	1,28	-
	-	65	-	91,5	-	-	-	1,14	-
	-	65	71,4	91,4	8	13	HJ310 E	1,20	0,15
	-	65	71,2	91,5	8	13	HJ310 E	1,27	0,15
	-	65	71,2	91,5	8	13	HJ310 E	1,16	0,15
	-	65	71,4	91,4	-	-	-	1,20	-
	-	65	71,2	91,5	-	-	-	1,31	-
	-	65	-	91,4	-	-	-	1,90	-
	-	65	-	91,5	-	-	-	1,94	-
	-	65	71,4	91,4	8	14,5	HJ2310 E	1,90	0,16
	-	65	70,5	91,5	8	14,5	HJ2310 E	1,97	0,16
	-	65	71,4	91,4	-	-	-	1,90	-
-	65	70,5	91,5	-	-	-	1,85	-	
110,8	-	78,8	-	-	-	-	2,10	-	
-	70,8	-	103,6	-	-	-	2,10	-	
-	70,8	78,8	103,6	9	14,5	HJ410	2,10	0,24	
-	70,8	78,8	103,6	-	-	-	2,20	-	

Single row cylindrical roller bearings

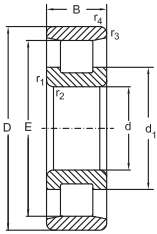

N

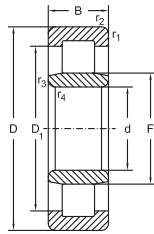

NU

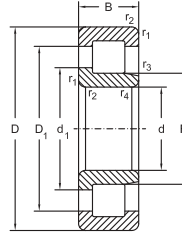

NJ

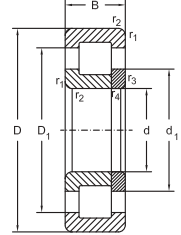

NUP

d	Dimensions					Basical radial load		Speed limit		Designation
	D	B	r_1, r_2 min.	r_3, r_4 min.	s \approx	dyn. C_r	stat. C_{10}	grease	oil	
mm						kN		min^{-1}		
55	90	18	1,1	1	2,6	41,5	50	7800	9200	NU1011 M
	90	18	1,1	1	-	37,7	43,8	8000	9500	NJ1011 M
	100	21	1,5	1,1	1,7	83	95	6300	7500	N211
	100	21	1,5	1,1	1,7	83	95	6300	7500	NU211 E
	100	21	1,5	1,1	1,7	83	95	6300	7500	NU211 EM
	100	21	1,5	1,1	1,7	83	95	6300	7500	NU211 ETN
	100	21	1,5	1,1	-	83	95	6300	7500	NJ211 E
	100	21	1,5	1,5	-	83	95	6300	7500	NJ211 EM
	100	21	1,5	1,5	-	83	95	6300	7500	NJ211 ETN
	100	21	1,5	1,1	-	83	95	6300	7500	NUP211 E
	100	21	1,5	1,5	-	83	95	6300	7500	NUP211 EM
	100	25	1,5	1,1	2,2	98	118	6300	7500	NU2211 E
	100	25	1,5	1,5	2,2	98	118	6300	7500	NU2211 EM
	100	25	1,5	1,1	-	98	118	6300	7500	NJ2211 E
	100	25	1,5	1,5	-	98	118	6300	7500	NJ2211 EM
	100	25	1,5	1,1	-	98	118	6300	7500	NUP2211 E
	100	25	1,5	1,5	2,2	98	118	6300	7500	NUP2211 EM
	120	29	2	2	3	134	140	5000	6000	N311
	120	29	2	2	3	134	140	5000	6000	NU311 E
	120	29	2	2	3	134	140	5000	6000	NU311 EM
	120	29	2	2	3	143	150	5000	6000	NU311 ETN
	120	29	2	2	-	134	140	5000	6000	NJ311 E
	120	29	2	2	-	134	140	5000	6000	NJ311 EM
	120	29	2	2	-	134	140	5000	6000	NJ311 ETN
	120	29	2	2	-	134	140	5000	6000	NUP311 E
	120	29	2	2	-	134	140	5000	6000	NUP311 EM
	120	43	2	2	3,8	187,3	212	5000	6000	NU2311 EM
	120	43	2	2	-	187,3	212	5000	6000	NJ2311 EM
120	43	2	2	-	187,3	212	5000	6000	NUP2311 EM	
140	33	2,1	2,1	3,3	140	137	4300	5000	N411 M	
140	33	2,1	2,1	3,3	140	137	4300	5000	NU411 M	
140	33	2,1	2,1	-	140	137	4300	5000	NJ411 M	
140	33	2,1	2,1	-	140	137	4300	5000	NUP411 M	

Single row cylindrical roller bearings

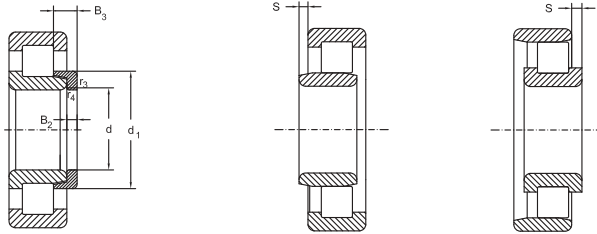

NJ+HJ

d	Dimensions						Thrust collar Designation	Mass	
	E	F	d_1 ≈	D_1 ≈	B_2	B_3		Bearing	Thrust collar
	mm							kg	
55	-	64,5	67,5	76,7	-	-	-	0,47	-
	-	64,5	-	76,7	5	10	HJ1011	0,47	0,05
	88,5	-	71,3	-	-	-	-	0,66	-
	-	66	-	85,6	-	-	-	0,75	-
	-	66	-	85,7	-	-	-	0,71	-
	-	66	-	85,7	-	-	-	0,64	-
	-	66	71	85,6	6	9,5	HJ211 E	0,75	0,09
	-	66	70,8	85,7	6	9,5	HJ211 E	0,69	0,09
	-	66	70,8	85,7	6	9,5	HJ211 E	0,66	0,09
	-	66	71	85,6	-	-	-	0,75	-
	-	66	70,8	85,7	-	-	-	0,72	-
	-	66	-	85,6	-	-	-	0,90	-
	-	66	-	85,9	-	-	-	0,88	-
	-	66	71	85,6	6	10	HJ2211 E	0,90	0,09
	-	66	70,9	85,9	6	10	HJ2211 E	0,90	0,09
	-	66	71	85,6	-	-	-	0,90	-
	-	66	70,9	85,9	-	-	-	0,92	-
	104,5	-	77,2	-	-	-	-	1,54	-
	-	70,5	-	100,3	-	-	-	1,60	-
	-	70,5	-	100,5	-	-	-	1,80	-
	-	70,5	-	100,5	-	-	-	1,50	-
	-	70,5	77,7	100,3	9	14	HJ311 E	1,60	0,2
	-	70,5	76,5	100,5	9	14	HJ311 E	1,85	0,2
	-	70,5	76,5	100,5	9	14	HJ311 E	1,52	0,2
	-	70,5	77,7	100,3	-	-	-	1,60	-
	-	70,5	76,5	100,5	-	-	-	1,86	-
	-	70,5	-	100,3	-	-	-	2,30	-
	-	70,5	77,7	100,3	9	15,5	HJ2311 E	2,30	0,2
	-	70,5	77,7	100,3	-	-	-	2,30	-
	117,2	-	85,2	-	-	-	-	2,50	-
-	77,2	-	109,9	-	-	-	2,50	-	
-	77,2	85,2	109,9	10	16,5	HJ411	2,50	0,31	
-	77,2	85,2	109,9	-	-	-	2,50	-	

Single row cylindrical roller bearings

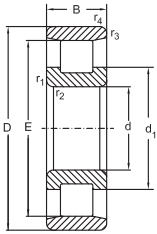

N

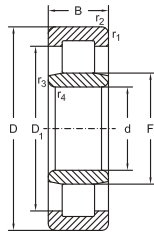

NU

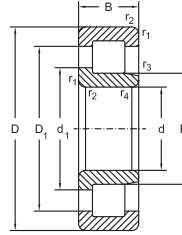

NJ

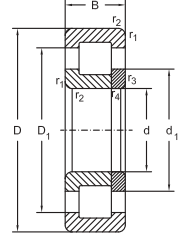

NUP

Dimensions						Basical radial load		Speed limit		Designation
d	D	B	r ₁ , r ₂ min.	r ₃ , r ₄ min.	s ≈	dyn. C _r	stat. C _{10r}	grease	oil	
mm						kN		min ⁻¹		
60	95	18	1,1	1	2,8	47,8	56	6700	8000	NU1012 EM
	110	22	1,5	1,5	1,6	95	104	5600	6700	N212 EM
	110	22	1,5	1,5	1,6	95	104	5600	6700	NU212 E
	110	22	1,5	1,5	1,6	95	104	5600	6700	NU212 EM
	110	22	1,5	1,5	-	95	104	5600	6700	NJ212 E
	110	22	1,5	1,5	-	95	104	5600	6700	NJ212 EM
	110	22	1,5	1,5	-	98,4	108,7	5600	6700	NJ212 ETN
	110	22	1,5	1,5	-	95	104	5600	6700	NUP212 E
	110	22	1,5	1,5	-	95	104	5600	6700	NUP212 EM
	110	28	1,5	1,5	2,4	129	153	5300	6300	NU2212 E
	110	28	1,5	1,5	2,4	129	153	5600	6700	NU2212 EM
	110	28	1,5	1,5	-	129	153	5300	6300	NJ2212 E
	110	28	1,5	1,5	-	129	153	5600	6700	NJ2212 EM
	110	28	1,5	1,5	-	129	153	5300	6300	NUP2212 E
	110	28	1,5	1,5	-	129	153	5600	6700	NUP2212 EM
	130	31	2,1	2,1	3	150	156	4500	5300	N312
	130	31	2,1	2,1	3	150	156	4300	5000	NU312 E
	130	31	3,5	3,5	3	150	156	4500	5300	NJ312 EM
	130	31	2,1	2,1	-	150	156	4300	5000	NJ312 E
	130	31	3,5	3,5	-	150	156	4500	5300	NJ312 EM
130	31	2,1	2,1	-	150	156	4300	5000	NUP312 E	
130	31	2,1	2,1	-	150	156	4500	5300	NUP312 EM	
130	46	2,1	2,1	4	224	260	4300	5000	NU2312 E	
130	46	2,1	2,1	4	224	260	4300	5000	NU2312 EM	
130	46	2,1	2,1	-	224	260	4300	5000	NJ2312 E	
130	46	2,1	2,1	-	224	260	4300	5000	NUP2312 E	
150	35	2,1	2,1	3,4	179	184	4000	4800	N412 M	
150	35	2,1	2,1	3,4	179	184	4000	4800	NU412 M	
150	35	2,1	2,1	-	179	184	4000	4800	NJ412 M	
150	35	2,1	2,1	-	179	184	4000	4800	NUP412 M	
65	100	18	1,1	1	3,3	45	58,5	6600	7800	NU1013 M
	100	18	1,1	1	3,3	45	58,5	6600	7800	N1013 M
	120	23	1,5	1,5	1,4	108	120	5300	6300	N213

Single row cylindrical roller bearings

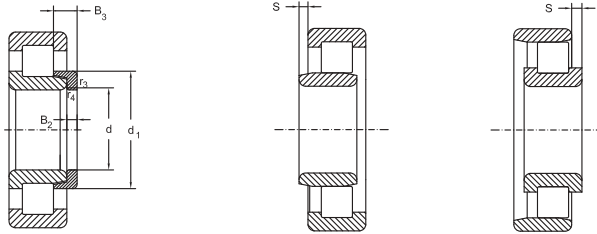

NJ+HJ

d	Dimensions						Thrust collar Designation	Mass	
	E	F	d_1 ≈	D_1 ≈	B_2	B_3		Bearing	Thrust collar
	mm							kg	
60	-	68,5	-	82,6	-	-	-	0,47	-
	100	-	77,7	-	-	-	-	0,89	-
	-	72	-	95,1	-	-	-	1	-
	-	72	-	95,2	-	-	-	0,90	-
	-	72	77,7	95,1	6	10	HJ212 E	1	0,11
	-	72	76,9	95,2	6	10	HJ212 E	0,91	0,11
	-	72	76,9	95,2	6	10	HJ212 E	0,82	0,11
	-	72	77,7	95,1	-	-	-	1	-
	-	72	76,9	95,2	-	-	-	1	-
	-	72	-	95,1	-	-	-	1,20	-
	-	72	-	95,2	-	-	-	1,27	-
	-	72	77,7	95,1	6	10	HJ2212 E	1,20	0,11
	-	72	76,9	92,2	6	10	HJ2212 E	1,29	0,11
	-	72	77,7	95,1	-	-	-	1,20	-
	-	73,5	78,8	99,6	-	-	-	1,31	-
	113	-	85	-	-	-	-	1,80	-
	-	77	-	108,5	-	-	-	1,90	-
	-	77	-	109,5	-	-	-	1,97	-
	-	77	84,5	108,5	9	14,5	HJ312 E	1,90	0,24
	-	77	83	109,5	9	14,5	HJ312 E	2,16	0,24
-	77	84,5	108,5	-	-	-	1,90	-	
-	77	83	109,5	-	-	-	2,04	-	
-	77	-	108,5	-	-	-	2,90	-	
-	77	-	109	-	-	-	2,97	-	
-	77	84,5	108,5	9	16	HJ2312 E	2,90	0,24	
-	77	84,5	108,5	-	-	-	2,90	-	
127	-	91,8	-	-	-	-	3,10	-	
-	83	-	118,8	-	-	-	3,10	-	
-	83	91,8	118,8	10	16,5	HJ412	3,10	0,35	
-	83	91,8	118,8	-	-	-	3,10	-	
65	-	74,5	77,5	86,7	-	-	-	0,52	-
	90,5	-	77,9	-	5	10	HJ1013	0,49	0,07
	105,6	-	85,4	-	-	-	-	1,06	-

Single row cylindrical roller bearings

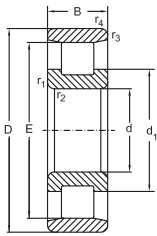

N

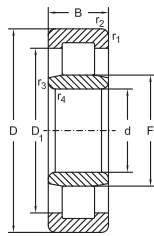

NU

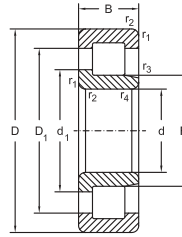

NJ

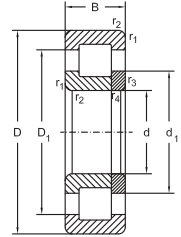

NUP

Dimensions						Basical radial load		Speed limit		Designation
d	D	B	r ₁ , r ₂ min.	r ₃ , r ₄ min.	s ≈	dyn. C _r	stat. C _{10r}	grease	oil	
mm						kN		min ⁻¹		
65	120	23	1,5	1,5	1,4	108	120	5300	6300	NU213 E
	120	23	1,5	1,5	1,4	108	120	5300	6300	NU213 EM
	120	23	1,5	1,5	1,4	108	120	5300	6300	NU213 EM6
	120	23	1,5	1,5	-	108	120	5300	6300	NJ213 E
	120	23	1,5	1,5	-	108	120	5300	6300	NJ213 EM
	120	23	1,5	1,5	-	108	120	5300	6300	NUP213 E
	120	23	1,5	1,5	-	108	120	5300	6300	NUP213 EM
	120	31	1,5	1,5	2,5	147	178	4800	5600	NU2213 EM
	120	31	1,5	1,5	-	147	178	4800	5600	NJ2213 EM
	120	31	1,5	1,5	-	147	178	4800	5600	NUP2213 EM
	140	33	2,1	2,1	1,4	180	190	4300	5000	N313 EM
	140	33	2,1	2,1	1,4	180	190	4300	5000	NU313 E
	140	33	3,5	3,5	1,4	180	190	4300	5000	NJ313 EM
	140	33	2,1	2,1	-	180	190	4300	5000	NJ313 E
	140	33	2,1	2,1	-	180	190	4300	5000	NJ313 EM
	140	33	2,1	2,1	-	180	190	4300	5000	NUP313 E
	140	33	3,5	3,5	-	180	190	4300	5000	NUP313 EM
	140	48	2,1	2,1	4,2	245	285	4000	4800	NU2313 EM
140	48	2,1	2,1	-	245	285	4000	4800	NJ2313 EM	
140	48	2,1	2,1	-	245	285	4000	4800	NUP2313 EM	
70	160	37	2,1	2,1	3,5	195	203	3800	4500	N413 M
	160	37	2,1	2,1	3,5	195	203	3800	4500	NU413 M
	160	37	2,1	2,1	-	195	203	3800	4500	NJ413 M
	160	37	2,1	2,1	-	195	203	3800	4500	NUP413 M
	110	20	1,1	1	3,4	65	81,5	6000	7000	NU1014 M
	110	20	1,1	1,1	-	65	81,5	6000	7000	NJ1014 M
	125	24	1,5	1,5	1,1	120	137	5000	6000	N214 EM
	125	24	1,5	1,5	1,1	120	137	5000	6000	NU214 E
	125	24	1,5	1,5	-	120	137	5000	6000	NJ214 E
	125	24	1,5	1,5	-	120	137	5000	6000	NJ214 EM
125	24	1,5	1,5	-	120	137	5000	6000	NUP214 E	
125	24	1,5	1,5	-	120	137	5000	6000	NUP214 EM	
125	31	1,5	1,5	2,6	156	196	4800	5600	NU2214 E	

Single row cylindrical roller bearings

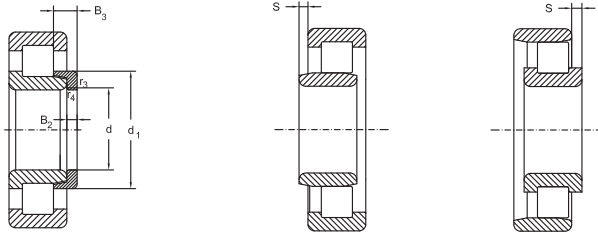

NJ+HJ

d	E	Dimensions					Thrust collar Designation	Mass	
		F	d_1 ≈	D_1 ≈	B_2	B_3		Bearing	Thrust collar
mm							kg		
65	-	78,5	-	103,2	-	-	-	1,20	-
	-	78,5	-	103,5	-	-	-	1,19	-
	-	78,5	-	103,5	-	-	-	1,19	-
	-	78,5	84,6	103,2	6	10	HJ213 E	1,20	0,13
	-	78,5	83,8	103,5	6	10	HJ213 E	1,22	0,13
	-	78,5	84,6	103,2	-	-	-	1,20	-
	-	78,5	83,8	103,5	-	-	-	1,14	-
	-	78,5	-	103,2	-	-	-	1,60	-
	-	78,5	84,6	103,2	6	10,5	HJ2213 E	1,60	0,13
	-	78,5	84,6	103,2	-	-	-	1,60	-
	124,5	-	89	-	-	-	-	2,30	-
	-	82,5	-	117,4	-	-	-	2,30	-
	-	82,5	-	118	-	-	-	2,45	-
	-	82,5	90,7	177,4	10	15,5	HJ313 E	2,30	0,29
	-	82,5	89	118	10	15,5	HJ313 E	2,49	0,29
	-	82,5	90,7	117,4	-	-	-	2,30	-
	-	82,5	89	118	-	-	-	2,55	-
	-	82,5	-	117,4	-	-	-	3,70	-
	-	82,5	89	118	10	18	HJ2313 E	3,70	0,3
	-	82,5	89	118	-	-	-	3,70	-
135,3	-	98,5	-	-	-	-	3,80	-	
-	89,3	-	126,9	-	-	-	3,80	-	
-	89,3	98,5	126,9	11	18	HJ413	3,80	0,43	
-	89,3	98,5	126,9	-	-	-	3,80	-	
70	-	80	84	95,3	-	-	-	0,75	-
	-	80	84	95,3	5	10	HJ1014	0,74	0,08
	113,5	-	88,8	-	-	-	-	1,30	-
	-	83,5	-	108,2	-	-	-	1,30	-
	-	83,5	89,6	108,2	7	11	HJ214 E	1,30	0,16
	-	83,5	88,8	108	7	11	HJ214 E	1,32	0,16
	-	83,5	89,6	108,2	-	-	-	1,30	-
	-	83,5	89	108	-	-	-	1,34	-
-	83,5	-	108,2	-	-	-	1,70	-	

Single row cylindrical roller bearings

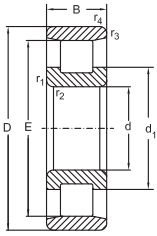

N

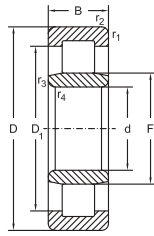

NU

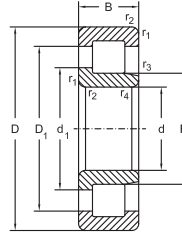

NJ

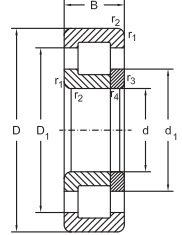

NUP

Dimensions						Basical radial load		Speed limit		Designation
d	D	B	r ₁ , r ₂ min.	r ₃ , r ₄ min.	s ≈	dyn. C _r	stat. C _{10r}	grease	oil	
mm						kN		min ⁻¹		
70	125	31	1,5	1,5	2,6	156	196	4800	5600	NU2214 EM
	125	31	1,5	1,5	-	156	196	4800	5600	NJ2214 E
	125	31	1,5	1,5	-	156	196	4800	5600	NJ2214 EM
	125	31	1,5	1,5	-	156	196	4800	5600	NUP2214 E
	125	31	1,5	1,5	-	156	196	4800	5600	NUP2214 EM
	150	35	2,1	2,1	1,6	205	222	4000	4800	N314
	150	35	2,1	2,1	1,6	205	222	4000	4800	NU314 E
	150	35	2,1	2,1	1,6	205	222	4000	4800	NJ314 EM6
	150	35	2,1	2,1	-	205	222	4000	4800	NJ314 E
	150	35	2,1	2,1	-	205	222	4000	4800	NUP314 E
	150	35	2,1	2,1	-	205	222	4000	4800	NUP314 EM
	150	51	2,1	2,1	4,4	275	325	3800	4500	NU2314 E
	150	51	2,1	2,1	4,4	275	325	3800	4500	NU2314 EM6
	150	51	2,1	2,1	-	275	325	3800	4500	NJ2314 E
	150	50	2,1	2,1	-	275	325	3800	4500	NJ2314 EM6
	150	51	2,1	2,1	-	275	325	3800	4500	NUP2314 E
150	51	2,1	2,1	-	275	325	3800	4500	NUP2314 EM6	
75	180	42	3	3	4	240	253	3400	4000	N414 M
	180	42	3	3	4	240	253	3400	4000	NU414 M
	180	42	3	3	-	240	253	3400	4000	NJ414 M
	180	42	3	3	-	240	253	3400	4000	NUP414 M
	115	20	1,1	1	3,4	65,5	85	5600	6600	NU1015 M
	130	25	1,5	1,5	1,2	132	156	4800	5600	N215 E
	130	25	1,5	1,5	1,2	132	156	4800	5600	NU215 E
	130	25	1,5	1,5	1,2	132	156	4800	5600	NU215 EM
	130	25	1,5	1,5	-	132	156	4800	5600	NJ215 E
	130	25	1,5	1,5	-	132	156	4800	5600	NUP215 E
	130	25	1,5	1,5	-	132	156	4800	5600	NUP215 EM
	130	31	1,5	1,5	2,6	151	190	4000	4800	NU2215 EM
130	31	1,5	1,5	-	151	190	4000	4800	NJ2215 EM	
130	31	1,5	1,5	-	151	190	4000	4800	NUP2215 EM	
160	37	2,1	2,1	1,8	240	265	4000	4800	N315 E	
160	37	2,1	2,1	1,8	240	265	4000	4800	NU315 E	

Single row cylindrical roller bearings

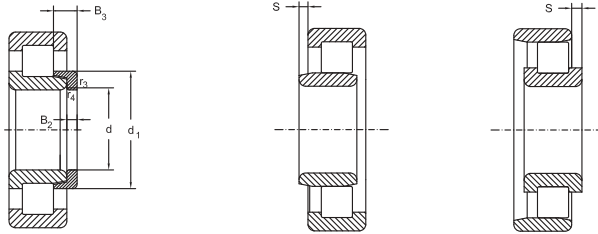

NJ+HJ

d	Dimensions						Thrust collar Designation	Mass	
	E	F	d_1 ≈	D_1 ≈	B_2	B_3		Bearing	Thrust collar
	mm							kg	
70	-	83,5	-	108,2	-	-	-	1,97	-
	-	83,5	89,6	108,2	7	11,5	HJ2214 E	1,70	0,15
	-	83,5	88,8	108,2	7	11,5	HJ2214 E	1,74	0,15
	-	83,5	89,6	108,2	-	-	-	1,70	-
	-	83,5	88,8	108,2	-	-	-	1,62	-
	130	-	98,9	-	-	-	-	2,68	-
	-	89	-	125,6	-	-	-	2,80	-
	-	89	-	125,9	-	-	-	3,21	-
	-	89	97,5	125,6	10	15,5	HJ314 E	2,80	0,34
	-	89	97,5	125,6	-	-	-	2,80	-
	-	89	98,5	125,9	-	-	-	3,27	-
	-	89	-	125,6	-	-	-	4	-
	-	89	-	125,9	-	-	-	4,51	-
	-	89	97,5	125,6	10	18,5	HJ2314 E	4	0,35
	-	89	95,5	125,9	10	18,5	HJ2314 E	4,53	0,35
	-	89	97,5	125,6	-	-	-	4	-
-	89	95,9	125,9	-	-	-	4,27	-	
152	-	110,3	-	-	-	-	5,50	-	
-	100	-	142	-	-	-	5,50	-	
-	100	110,3	142	12	20	HJ414	5,50	0,61	
-	100	110,3	142	-	-	-	5,50	-	
75	-	85	89	100,9	-	-	-	0,75	-
	118,5	-	94,5	-	-	-	-	1,25	-
	-	88,5	-	113,2	-	-	-	1,25	-
	-	88,5	-	113	-	-	-	1,38	-
	-	88,5	94,5	113,2	7	11	HJ215 E	1,25	0,17
	-	88,5	94,5	113,2	-	-	-	1,25	-
	-	88,5	94	113	-	-	-	1,42	-
	-	88,5	-	113,2	-	-	-	1,60	-
	-	88,5	94,5	113,2	7	11,5	HJ2215 E	1,60	0,17
	-	88,5	94,5	113,2	-	-	-	1,60	-
	143	-	104,3	-	-	-	-	3,93	-
	-	95	-	135	-	-	-	3,40	-

Single row cylindrical roller bearings

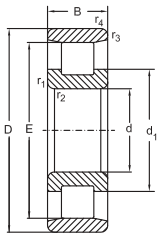

N

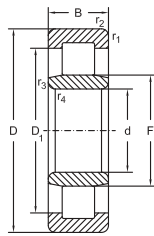

NU

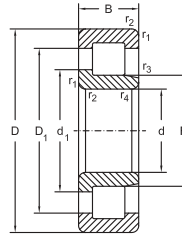

NJ

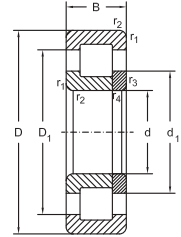

NUP

Dimensions						Basical radial load		Speed limit		Designation
d	D	B	r ₁ , r ₂ min.	r ₃ , r ₄ min.	s ≈	dyn. C _r	stat. C _{0r}	grease	oil	
mm						kN		min ⁻¹		
75	160	37	3,5	3,5	1,8	240	265	4000	4800	NU315 EM
	160	37	2,1	2,1	-	240	265	4000	4800	NJ315 E
	160	37	2,1	2,1	-	240	265	4000	4800	NJ315 EM
	160	37	2,1	2,1	-	240	265	4000	4800	NUP315 E
	160	37	2,1	2,1	-	240	265	4000	4800	NUP315 EM
	160	55	2,1	2,1	4,5	329	395	4000	4800	NU2315 E
	160	55	2,1	2,1	4,5	329	395	4000	4800	NU2315 EM
	160	55	2,1	2,1	-	329	395	4000	4800	NJ2315 E
	160	55	2,1	2,1	-	329	395	4000	4800	NJ2315 EM
	160	55	2,1	2,1	-	329	395	4000	4800	NUP2315 E
80	190	45	3	3	4,2	277	294	4000	4800	N415 M
	190	45	3	3	4,2	277	294	4000	4800	NU415 M
	190	45	3	3	-	277	294	4000	4800	NJ415 M
	190	45	3	3	-	277	294	4000	4800	NUP415 M
	125	22	1,1	1	3,6	76,5	98	5200	6200	NU1016 M
	125	16,5	2	2	3,6	68,2	85,2	5200	6200	NP1016 MB
	140	26	2	2	1,2	140	170	4300	5000	N216 E
	140	26	2	2	1,2	140	170	4300	5000	NU216 E
	140	26	2	2	1,2	140	170	4300	5000	NU216 EM
	140	26	2	2	-	140	170	4300	5000	NJ216 E
	140	26	2	2	-	140	170	4300	5000	NUP216 E
	140	26	2	2	-	140	170	4300	5000	NUP216 EM
	140	33	2	2	2,7	186	245	4300	5000	NU2216 EM
140	33	2	2	-	186	245	4300	5000	NJ2216 EM	
140	33	2	2	-	186	245	4300	5000	NUP2216 EM	
170	39	2,1	2,1	2,1	255	275	3600	4300	N316	
170	39	2,1	2,1	2,1	255	275	3600	4300	NU316 E	
170	39	2,1	2,1	2,1	255	275	3600	4300	NU316 EM	
170	39	2,1	2,1	2,1	255	275	3600	4300	NU316 ETN	
170	39	2,1	2,1	-	255	275	3600	4300	NJ316 E	
170	39	2,1	2,1	-	255	275	3600	4300	NJ316 EM	
170	39	2,1	2,1	-	255	275	3600	4300	NUP316 E	

Single row cylindrical roller bearings

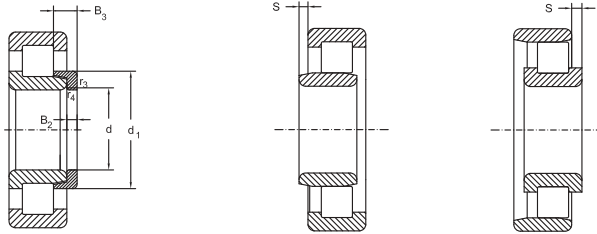

NJ+HJ

d	E	Dimensions					Thrust collar Designation	Mass	
		F	d_1 ≈	D_1 ≈	B_2	B_3		Bearing	Thrust collar
mm							kg		
75	-	95	-	135,5	-	-	-	3,83	-
	-	95	104,3	135	11	16,5	HJ315 E	3,40	0,42
	-	95	102,5	135,5	11	16,5	HJ315 E	3,87	0,42
	-	95	104,3	135	-	-	-	3,40	-
	-	95	102,5	135,5	-	-	-	3,83	-
	-	95	-	135	-	-	-	5	-
	-	95	-	135,5	-	-	-	5,54	-
	-	95	104,3	135	11	19,5	HJ2315 E	5	0,43
	-	95	102,5	135,5	11	19,5	HJ2315 E	5,62	0,43
	-	95	104,3	135	-	-	-	5	-
	-	95	102,5	135,5	-	-	-	5,30	-
	160,5	-	116	-	-	-	-	6,45	-
80	-	104,5	-	149,8	-	-	-	6,45	-
	-	104,5	116	149,8	13	21,5	HJ415	6,45	0,71
	-	104,5	116	149,8	-	-	-	6,45	-
	-	91,5	96	109,1	-	-	-	1,03	-
	113,5	-	96,2	110	-	-	-	1,05	-
	127,3	-	101,7	-	-	-	-	1,54	-
	-	95,3	-	121,6	-	-	-	1,54	-
	-	95,3	-	121,8	-	-	-	1,69	-
	-	95,3	101,7	121,6	8	12,5	HJ216 E	1,54	0,22
	-	95,3	101,7	121,6	-	-	-	1,54	-
	-	95,3	100,8	121,8	-	-	-	1,76	-
	-	95,3	-	121,6	-	-	-	2,34	-
	-	95,3	101,7	121,6	8	12,5	HJ2216 E	2,40	0,22
	-	95,3	101,7	121,6	-	-	-	2,52	-
147	-	112,6	-	-	-	-	4,25	-	
-	101	-	142,7	-	-	-	3,95	-	
-	101	-	143,2	-	-	-	4,28	-	
-	101	-	143,2	-	-	-	3,93	-	
-	101	110,6	142,7	11	17	HJ316 E	3,95	0,47	
-	101	108,7	143,2	11	17	HJ316 E	4,19	0,47	
-	101	110,6	142,7	-	-	-	3,95	-	

Single row cylindrical roller bearings

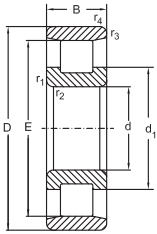

N

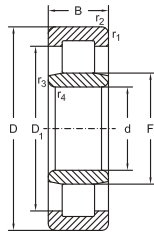

NU

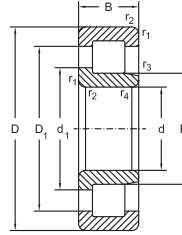

NJ

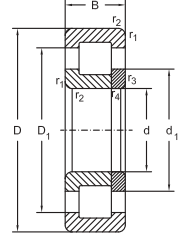

NUP

Dimensions						Basical radial load		Speed limit		Designation
d	D	B	r ₁ , r ₂ min.	r ₃ , r ₄ min.	s ≈	dyn. C _r	stat. C _{10r}	grease	oil	
mm						kN		min ⁻¹		
80	170	39	2,1	2,1	-	255	275	3600	4300	NUP316 EM
	170	58	2,1	2,1	5	352	424	3600	4300	NU2316 EM
	170	58	2,1	2,1	-	352	424	3600	4300	NJ2316 EM
	170	58	2,1	2,1	-	352	424	3600	4300	NUP2316 EM
	200	48	3	3	4,6	316	339	3000	3600	N416 M
	200	48	3	3	4,6	316	339	3000	3600	NU416 M
	200	48	3	3	-	316	339	3000	3600	NJ416 M
85	200	48	3	3	-	316	339	3000	3600	NUP416 M
	130	22	1,1	1	3,8	78	104	4800	5600	NU1017 M
	150	28	2	2	1,5	165	194	4300	5000	N217
	150	28	2	2	1,5	165	194	4300	5000	NU217 E
	150	28	2	2	1,5	165	194	4300	5000	NU217 EM
	150	28	2	2	-	165	194	4300	5000	NJ217 E
	150	28	2	2	-	165	194	4300	5000	NUP217 E
	150	28	2	2	-	165	114	4300	5000	NUP217 EM
	150	36	2	2	2,7	216	275	3800	4500	NU2217 E
	150	36	2	2	2,7	216	275	3800	4500	NU2217 EM
	150	36	2	2	-	216	275	3800	4500	NJ2217 E
	150	36	2	2	-	216	275	3800	4500	NUP2217 EM
	150	36	2	2	-	216	275	3800	4500	NUP2217 E
	150	36	2	2	-	216	275	3800	4500	NUP2217 EM
	180	41	3	3	2,3	288	325	3400	4000	N317 EMB
	180	41	3	3	2,3	288	325	3400	4000	NU317 E
	180	41	3	3	2,3	288	325	3400	4000	NU317 EM
	180	41	3	3	-	288	325	3400	4000	NJ317 E
	180	41	3	3	-	288	325	3400	4000	NJ317 EM
	180	41	3	3	-	288	325	3400	4000	NUP317 E
	180	60	3	3	5	367	444	3400	4000	NU2317 EM
	180	60	3	3	-	367	444	3400	4000	NJ2317 EM
	180	60	3	3	-	367	444	3400	4000	NUP2317 EM
210	52	4	4	5	357	384	2800	3400	N417 M	
210	52	4	4	5	357	384	2800	3400	NU417 M	
210	52	4	4	-	357	384	2800	3400	NJ417 M	

Single row cylindrical roller bearings

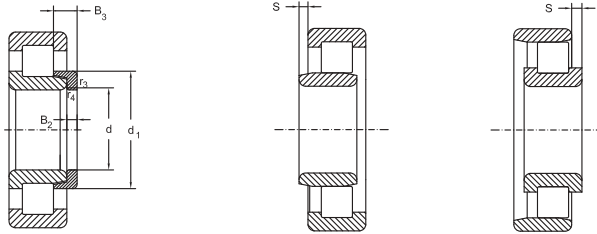

NJ+HJ

d	E	Dimensions					Thrust collar Designation	Mass	
		F	d_1 ≈	D_1 ≈	B_2	B_3		Bearing	Thrust collar
mm							kg		
80	-	101	108,8	143,2	-	-	-	4,59	-
	-	101	-	142,7	-	-	-	6,60	-
	-	101	110,6	142,7	11	20	HJ2316 E	6,70	0,5
	-	101	110,6	142,7	-	-	-	6,68	-
	170	-	122	-	-	-	-	8,30	-
	-	110	-	158,8	-	-	-	8,30	-
	-	110	122	158,8	13	22	HJ416	8,30	0,79
85	-	96,5	101	114,1	-	-	-	1,1	-
	133,8	-	108,8	-	-	-	-	1,9	-
	-	100,5	-	130,3	-	-	-	1,9	-
	-	100,5	-	130,5	-	-	-	2,12	-
	-	100,5	107,6	130,3	8	12,5	HJ217 E	1,9	0,25
	-	100,5	107,6	130,3	-	-	-	1,9	-
	-	100,5	107,5	130,5	-	-	-	2,23	-
	-	100,5	-	130,3	-	-	-	2,60	-
	-	100,5	-	130,5	-	-	-	2,76	-
	-	100,5	107,6	130,3	8	13	HJ2217 E	2,60	0,25
	-	100,5	106,5	130,5	8	13	HJ2217 E	2,87	0,25
	-	100,5	107,6	130,3	-	-	-	2,60	-
	-	100,5	106,5	130,5	-	-	-	2,80	-
	160	-	118	-	-	-	-	5,04	-
	-	108	-	151,3	-	-	-	5,30	-
	-	108	-	151,9	-	-	-	5,45	-
	-	108	118	151,3	12	18,5	HJ317 E	5,30	0,58
	-	108	116,5	151,9	12	18,5	HJ317 E	5	0,58
	-	108	118	151,3	-	-	-	5,30	-
	-	108	-	151,3	-	-	-	7,49	-
-	108	118	151,3	12	22	HJ2317 E	7,61	0,6	
-	108	118	151,3	-	-	-	7,77	-	
177	-	126	-	-	-	-	9,80	-	
-	113	-	164,8	-	-	-	9,80	-	
-	113	126	164,8	14	24	HJ417	9,80	0,92	

Single row cylindrical roller bearings

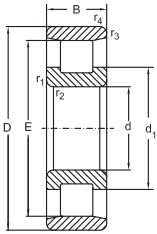

N

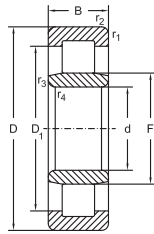

NU

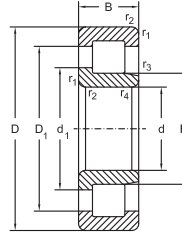

NJ

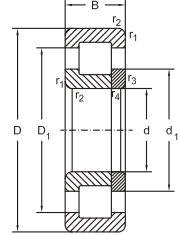

NUP

d	Dimensions					Basical radial load		Speed limit		Designation	
	D	B	r_1, r_2 min.	r_3, r_4 min.	s \approx	dyn. C_r	stat. C_{10}	grease	oil		
mm						kN		min^{-1}			
85	210	52	4	4	-	357	384	2800	3400	NUP417 M	
	140	24	1,5	1,1	4	93	125	4500	5300	NU1018 M	
	160	30	2	2	1,8	183	216	3800	4500	N218 M	
	160	30	2	2	1,8	183	216	3800	4500	NU218 E	
	160	30	2	2	1,8	183	216	3800	4500	NU218 EM	
	160	30	2	2	-	183	216	3800	4500	NJ218 E	
	160	30	2	2	-	183	216	3800	4500	NJ218 EM	
	160	30	2	2	-	183	216	3800	4500	NUP218 E	
	160	30	2	2	-	183	216	3800	4500	NUP218 EM	
	160	40	2	2	2,9	240	315	3200	3800	NU2218 E	
	160	40	2	2	-	240	315	3200	3800	NJ2218 E	
	160	40	2	2	-	240	315	3200	3800	NUP2218 E	
	90	190	43	3	3	2,5	315	345	3200	3800	N318 EMB
		190	43	3	3	2,5	315	345	3200	3800	NU318 E
		190	43	3	3	2,5	315	345	3200	3800	NU318 EM
		190	43	3	3	2,5	329	374	3200	3800	NU318 ETN
		190	43	3	3	-	315	345	3200	3800	NJ318 E
		190	43	3	3	-	315	345	3200	3800	NJ318 EM
		190	43	3	3	-	315	345	3200	3800	NUP318 E
190		43	3	3	-	315	345	3200	3800	NUP318 EM	
190		64	3	3	6	430	530	3000	3600	NU2318 E	
190		64	3	3	6	430	530	3000	3600	NU2318 EM	
190		64	3	3	-	430	530	3000	3600	NJ2318 E	
190		64	3	3	-	430	530	3200	3800	NJ2318 EM	
190		64	3	3	-	430	530	3000	3600	NUP2318 E	
95	225	54	4	4	5	393	427	2800	3400	N418 M	
	225	54	4	4	5	393	427	2800	3400	NU418 M	
	225	54	4	4	-	393	427	2800	3400	NJ418 M	
	225	54	4	4	-	393	427	2800	3400	NUP418 M	
	145	24	1,5	1,1	4,1	96,5	129	4400	5200	NU1019 M	
	170	32	2,1	2,1	1,7	210	249	3800	4500	N219	
	170	32	2,1	2,1	1,7	210	249	3800	4500	NU219 EM	
	170	32	2,1	2,1	-	210	249	3800	4500	NJ219 EM	

Single row cylindrical roller bearings

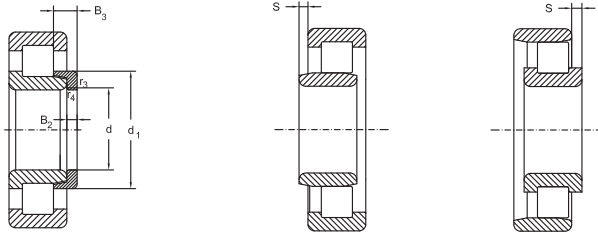

NJ+HJ

d	Dimensions						Thrust collar Designation	Mass	
	E	F	d_1 ≈	D_1 ≈	B_2	B_3		Bearing	Thrust collar
mm								kg	
85	-	113	126	164,8	-	-	-	9,80	-
	-	103	108	122,1	-	-	-	1,4	-
	143	-	114,2	-	-	-	-	2,59	-
	-	107	-	138,5	-	-	-	2,40	-
	-	107	-	139	-	-	-	2,73	-
	-	107	114,5	138,5	9	14	HJ218 E	2,70	0,33
	-	107	113	139	9	14	HJ218 E	2,79	0,33
	-	107	114,5	138,5	-	-	-	2,40	-
	-	107	113	139	-	-	-	2,84	-
	-	107	-	138,5	-	-	-	3,20	-
90	-	107	114,5	138,5	9	15	HJ2218 E	3,20	0,32
	-	107	114,5	138,5	-	-	-	3,20	-
	169,5	-	124	-	-	-	-	5,93	-
	-	113,5	-	160,2	-	-	-	5,40	-
	-	113,5	-	160,8	-	-	-	6,35	-
	-	115,5	-	160,8	-	-	-	5,50	-
	-	113,5	124	160,2	12	18,5	HJ318 E	5,40	0,63
	-	113,5	122,2	160,8	12	18,5	HJ318 E	6,14	0,63
	-	113,5	124	160,2	-	-	-	5,40	-
	-	113,5	122,2	160,8	-	-	-	6,22	-
	-	113,5	-	160,2	-	-	-	8,10	-
	-	113,5	-	154,3	-	-	-	8,82	-
	-	113,5	124	160,2	12	22	HJ2318 E	8,10	0,68
	-	113,5	122,2	154,3	12	22	HJ2318 E	9,02	0,68
	-	113,5	124	160,2	-	-	-	8,10	-
	191,5	-	137	-	-	-	-	11,50	-
-	123,5	-	178,8	-	-	-	11,50	-	
-	123,5	137	178,8	14	24	HJ418	11,50	1,1	
-	123,5	137	178,8	-	-	-	11,50	-	
95	-	108	113	127,1	-	-	-	1,45	-
	151,5	-	122	-	-	-	-	2,88	-
	-	112,5	-	147,4	-	-	-	3,24	-
	-	112,5	120,7	147,4	9	14	HJ219 E	3,25	0,35

Single row cylindrical roller bearings

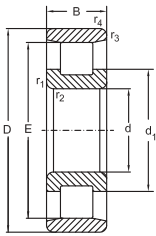

N

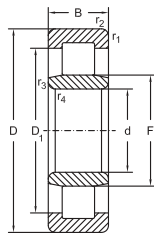

NU

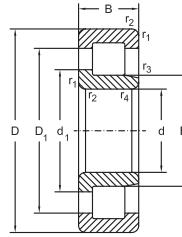

NJ

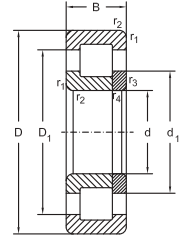

NUP

Dimensions						Basical radial load		Speed limit		Designation
d	D	B	r ₁ , r ₂ min.	r ₃ , r ₄ min.	s ≈	dyn. C _r	stat. C _{0r}	grease	oil	
mm						kN		min ⁻¹		
95	170	32	2,1	2,1	-	210	249	3800	4500	NUP219 EM
	170	43	2,1	2,1	3,5	273	349	3200	3800	NU2219 EM
	170	43	2,1	2,1	-	273	349	3200	3800	NJ2219 EM
	170	43	2,1	2,1	-	273	349	3200	3800	NUP2219 EM
	200	45	3	3	2,9	311	351	3000	3600	N319
	200	45	3	3	2,9	311	351	3000	3600	NU319 EM
	200	45	3	3	-	311	351	3000	3600	NJ319 EM
	200	45	3	3	-	311	351	3000	3600	NUP319 EM
	200	67	3	3	6,2	388	488	2800	3400	N2319 M
	200	67	3	3	6,2	388	488	2800	3400	NU2319 M
	200	67	3	3	-	388	488	2800	3400	NJ2319 M
	200	67	3	3	-	388	488	2800	3400	NUP2319 M
	100	240	55	4	4	5,2	415	465	2400	3000
240		55	4	4	5,2	415	465	2400	3000	NU419 M
240		55	4	4	-	415	465	2400	3000	NJ419 M
240		55	4	4	-	415	465	2400	3000	NUP419 M
150		24	1,5	1,1	4,2	98	134	4300	5000	NU1020 M
180		34	2,1	2,1	1,7	251	305	3200	3800	N220 E
180		34	2,1	2,1	1,7	251	305	3200	3800	NU220 E
180		34	2,1	2,1	1,7	251	305	3200	3800	NU220 EM
180		34	2,1	2,1	-	251	305	3200	3800	NJ220 E
180		34	2,1	2,1	-	251	305	3200	3800	NJ220 EM
180		34	2,1	2,1	-	251	305	3200	3800	NUP220 E
180		34	2,1	2,1	-	251	305	3200	3800	NUP220 EM
180		46	2,1	2,1	3,5	335	440	3000	3800	NU2220 E
180	46	2,1	2,1	3,5	335	440	3000	3800	NU2220 EM	
180	46	2,1	2,1	-	335	440	3000	3600	NJ2220 E	
180	46	2,1	2,1	-	335	440	3000	3600	NJ2220 EM	
180	46	2,1	2,1	-	335	440	3000	3600	NUP2220 E	
215	47	3	3	3	380	425	3000	3600	N320 E	
215	47	3	3	3	380	425	3000	3600	N320 EM	
215	47	3	3	3	380	425	3000	3600	NU320 E	
215	47	3	3	3	380	425	3000	3600	NUP320 E	

Single row cylindrical roller bearings

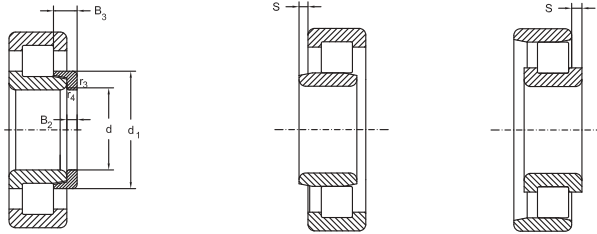

NJ+HJ

d	Dimensions						Thrust collar Designation	Mass	
	E	F	d_1 ≈	D_1 ≈	B_2	B_3		Bearing	Thrust collar
	mm							kg	
95	-	112,5	120,7	147,4	-	-	-	3,33	-
	-	112,5	-	147,4	-	-	-	4,29	-
	-	112,5	120,7	147,4	9	15,5	HJ2219 E	4,38	0,37
	-	112,5	120,7	147,4	-	-	-	4,42	-
	173,5	-	133	-	-	-	-	6,47	-
	-	121,5	-	168,2	-	-	-	7	-
	-	121,5	132,2	168,2	13	20,5	HJ319 E	7,20	0,8
	-	121,5	132,2	168,2	-	-	-	7,26	-
	173,5	-	132	-	-	-	-	10,30	-
	-	121,5	-	168,2	-	-	-	10,50	-
	-	121,5	132,2	168,2	13	24,5	HJ2319 E	10,50	0,93
	-	121,5	132,2	168,2	-	-	-	10,90	-
	201,5	-	147	-	-	-	-	13,80	-
	-	133,5	-	188,8	-	-	-	13,80	-
-	133,5	147	188,8	15	25,5	HJ419	13,80	1,3	
-	133,5	147	188,8	-	-	-	13,80	-	
-	113	118	132,1	-	-	-	1,50	-	
100	163	-	127,3	-	-	-	-	3,44	-
	-	119	-	155,5	-	-	-	3,44	-
	-	119	-	157	-	-	-	3,77	-
	-	119	127,3	155,5	10	15	HJ220 E	3,44	0,44
	-	119	127	157	10	15	HJ220 E	3,49	0,44
	-	119	127,3	155,5	-	-	-	3,44	-
	-	119	127	164,5	-	-	-	3,89	-
	-	119	-	155,5	-	-	-	5,50	-
	-	120	-	159	-	-	-	5,23	-
	-	119	127,3	155,5	10	16	HJ2220 E	5,50	0,45
	-	128	120	159	10	16	HJ2220 E	5,23	0,45
	-	119	127,3	155,5	-	-	-	5,50	-
	191,5	-	139,6	-	-	-	-	7,70	-
	185,5	-	138,5	-	-	-	-	8,59	-
	-	127,5	-	181	-	-	-	7,70	-
	-	127,5	-	173,5	-	-	-	8,73	-

Single row cylindrical roller bearings

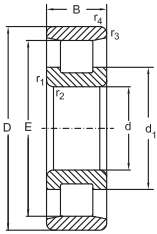

N

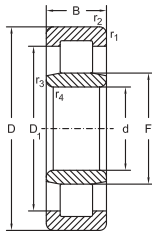

NU

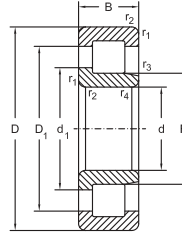

NJ

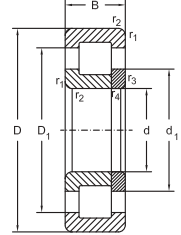

NUP

Dimensions						Basical radial load		Speed limit		Designation
d	D	B	r ₁ , r ₂ min.	r ₃ , r ₄ min.	s ≈	dyn. C _r	stat. C _{0r}	grease	oil	
mm						kN		min ⁻¹		
100	215	47	3	3	-	380	425	3000	3600	NJ320 E
	215	47	3	3	-	380	425	3000	3600	NJ320 EM
	215	47	3	3	-	380	425	3000	3600	NUP320 E
	215	73	3	3	6,3	570	720	2600	3200	NU2320 E
	215	73	3	3	-	570	720	2600	3200	NJ2320 E
	215	73	4	4	-	570	720	2600	3200	NJ2320 EM
	215	73	3	3	-	570	720	2600	3200	NUP2320 E
	250	58	4	4	5,7	440	490	2400	3000	N420 M
	250	58	4	4	5,7	440	490	2400	3000	NU420 M
105	250	58	4	4	-	440	490	2400	3000	NJ420 M
	250	58	4	4	-	440	490	2400	3000	NUP420 M
	160	26	2	1,1	4,4	112	153	3800	4500	NU1021 M
	160	26	2	2	-	112	153	3800	4500	NJ1021 M
	190	36	2,1	2,1	2	260	320	3000	3600	N221 E
	190	36	2,1	2,1	2	260	320	3000	3600	NU221 E
	190	36	2,1	2,1	-	260	320	3000	3600	NJ221 E
	190	36	2,1	2,1	-	260	320	3000	3600	NJ221 EM
	190	36	2,1	2,1	-	260	320	3000	3600	NUP221 E
	225	49	3	3	3	335	380	2600	3200	N321 E
	225	49	3	3	3	335	380	2600	3200	NU321 E
	225	49	3	3	3	335	380	2600	3200	NU321 EM
	225	49	3	3	-	335	380	2600	3200	NJ321 E
	225	49	3	3	-	335	380	2600	3200	NJ321 EM
225	49	3	3	-	335	380	2600	3200	NUP321 E	
260	60	4	4	5,7	490	540	2200	2800	NU421 M	
260	60	4	4	-	490	540	2200	2800	NJ421 M	
260	60	4	4	-	490	540	2200	2800	NUP421 M	
110	170	28	2	1,1	4,5	140	190	3600	4500	NU1022 M
	200	38	2,1	2,1	2,1	292	365	3000	3600	N222 E
	200	38	2,1	2,1	2,1	292	365	3000	3600	NU222 E
	200	38	2,1	2,1	2,1	292	365	3000	3600	NU222 EM
	200	38	2,1	2,1	-	292	365	3000	3600	NJ222 E
	200	38	2,1	2,1	-	292	365	3000	3600	NJ222 EM

Single row cylindrical roller bearings

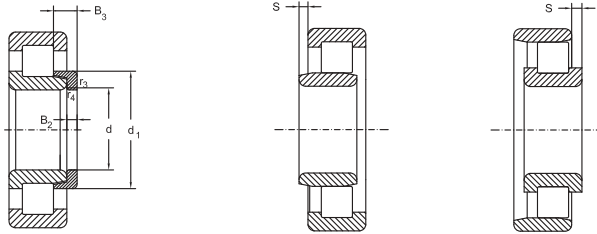

NJ+HJ

d	Dimensions						Thrust collar Designation	Mass	
	E	F	d_1 ≈	D_1 ≈	B_2	B_3		Bearing	Thrust collar
	mm							kg	
100	-	127,5	139,6	181	13	20,5	HJ320 E	7,70	0,9
	-	127,5	139	173,5	13	20,5	HJ320 E	8,61	0,9
	-	127,5	139,6	181	-	-	-	7,70	-
	-	127,5	-	181	-	-	-	12	-
	-	127,5	139,6	181	13	23,5	HJ2320 E	12	0,95
	-	127,5	139	181,5	13	23,5	HJ2320 E	13,26	0,95
	-	127,5	139,6	181	-	-	-	12	-
	211	-	153,5	-	-	-	-	15,80	-
	-	139	-	197	-	-	-	15,80	-
105	-	139	153,5	197	16	27	HJ420	15,80	1,6
	-	139	153,5	197	-	-	-	15,80	-
	-	119,5	124,5	140,3	-	-	-	1,90	-
	-	119,5	-	140,3	7	13,5	HJ1021	1,91	0,24
	171,5	-	134,7	-	-	-	-	4,10	-
	-	125,5	-	163	-	-	-	4,10	-
	-	125,5	134,7	163	10	16	HJ221 E	4,10	0,52
	-	125,5	134,5	164,5	10	16	HJ221 E	4,56	0,52
	-	125,5	134,7	163	-	-	-	4,10	-
	195	-	147	-	-	-	-	9,10	-
	-	135	-	183,8	-	-	-	9,10	-
	-	133	-	191	-	-	-	9,91	-
	-	135	147	183,8	13	20,5	HJ321 E	9,10	1
	-	133	143	191	13	20,5	HJ321 E	10,03	1
	-	135	147	183,8	-	-	-	9,10	-
-	144,5	-	206	-	-	-	17,50	-	
-	144,5	159,5	206	16	27	HJ421	17,50	1,7	
-	144,5	159,5	206	-	-	-	17,50	-	
110	-	125	131	149	-	-	-	2,40	-
	180,5	-	141,6	-	-	-	-	4,90	-
	-	132,5	-	172,4	-	-	-	4,90	-
	-	132,5	-	174	-	-	-	5,30	-
	-	132,5	141,6	172,4	11	17	HJ222 E	4,90	0,62
	-	132,5	141	174	11	17	HJ222 E	5,40	0,62

Single row cylindrical roller bearings

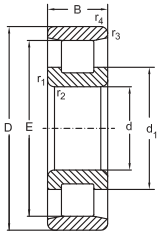

N

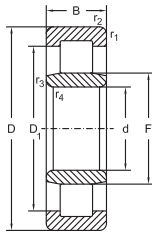

NU

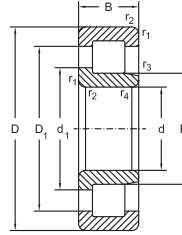

NJ

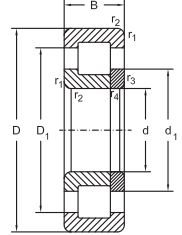

NUP

Dimensions						Basical radial load		Speed limit		Designation
d	D	B	$r_{1,2}$ min.	$r_{3,4}$ min.	s ≈	dyn. C_r	stat. C_{10}	grease	oil	
mm						kN		min^{-1}		
110	200	38	2,1	2,1	-	292	365	3000	3600	NUP222 E
	200	38	2,1	2,1	-	292	365	3000	3600	NUP222 EM
	200	53	2,1	2,1	4	380	520	2800	3400	NU2222 E
	200	53	2,1	2,1	4	380	520	2800	3400	NU2222 EM
	200	53	2,1	2,1	-	380	520	2800	3400	NJ2222 E
	200	53	2,1	2,1	-	380	520	2800	3400	NJ2222 EM
	200	53	2,1	2,1	-	380	520	2800	3400	NUP2222 E
	240	50	3	3	3,2	443	513	2400	3000	N322 E
	240	50	3	3	3,2	443	513	2400	3000	NU322 E
	240	50	3	3	3,2	443	513	2400	3000	NU322 EM
	240	50	3	3	-	443	513	2400	3000	NJ322 E
	240	50	3	3	-	443	513	2400	3000	NUP322 E
	240	50	3	3	-	443	513	2400	3000	NUP322 EM
	240	80	3	3	7,2	630	800	2200	2800	NU2322 E
	240	80	3	3	7,2	630	800	2200	2800	NU2322 EM
	240	80	3	3	-	630	800	2200	2800	NJ2322 E
	240	80	3	3	-	630	800	2200	2800	NJ2322 EM
	240	80	3	3	-	630	800	2200	2800	NUP2322 E
120	280	65	4	4	6,2	583	672	2200	2800	NU422 M
	280	65	4	4	-	583	672	2200	2800	NJ422 M
	280	65	4	4	-	583	672	2200	2800	NUP422 M
	180	28	2	1	4,5	150	208	3400	4000	NU1024 M
	215	40	2,1	2,1	2,5	335	415	2600	3200	N224 E
	215	40	2,1	2,1	2,5	335	415	2600	3200	NU224 E
	215	40	2,1	2,1	2,5	335	415	2600	3200	NU224 EM
	215	40	2,1	2,1	2,5	335	415	2600	3200	NU224 EM6
	215	40	2,1	2,1	-	335	415	2600	3200	NJ224 E
	215	40	2,1	2,1	-	335	415	2600	3200	NJ224 EM
	215	40	2,1	2,1	-	335	415	2600	3200	NUP224 E
	215	58	2,1	2,1	4,1	450	610	2600	3200	NU2224 E
215	58	2,1	2,1	-	450	610	2600	3200	NJ2224 E	
215	58	2,1	2,1	-	450	610	2600	3200	NJ2224 EM	
215	58	2,1	2,1	-	450	610	2600	3200	NUP2224 E	

Single row cylindrical roller bearings

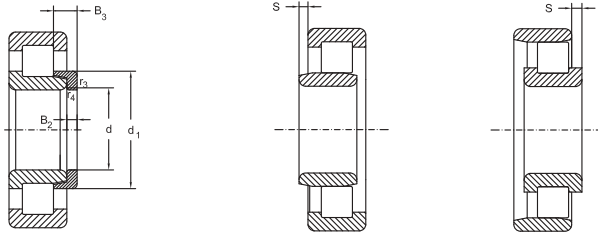

NJ+HJ

d	E	Dimensions					Thrust collar Designation	Mass	
		F	d_1 ≈	D_1 ≈	B_2	B_3		Bearing	Thrust collar
		mm							kg
110	-	132,5	141,6	172,4	-	-	-	4,90	-
	-	132,5	141	174	-	-	-	5,50	-
	-	132,5	-	172,4	-	-	-	6,70	-
	-	132,5	-	174	-	-	-	7,40	-
	-	132,5	141,6	172,4	11	19,5	HJ2222 E	6,70	0,65
	-	132,5	142	174	11	19,5	HJ2222 E	7,30	0,65
	-	132,5	141,6	172,4	-	-	-	6,70	-
	211	-	155,9	-	-	-	-	10,50	-
	-	143	-	199,9	-	-	-	10,50	-
	-	143	-	201	-	-	-	11,50	-
	-	143	155,9	199,9	14	22	HJ322 E	10,50	1,2
	-	143	155,9	199,9	-	-	-	10,50	-
	-	143	155	201	-	-	-	11,90	-
	-	143	-	199,9	-	-	-	17	-
	-	143	-	201	-	-	-	19,10	-
	-	143	155,9	199,9	14	26,5	HJ2322 E	17	1,3
-	143	155	201	14	26,5	HJ2322 E	19,40	1,3	
-	143	155,9	199,9	-	-	-	17	-	
-	155	-	219,5	-	-	-	20,80	-	
-	155	171	219,5	17	29,5	HJ422	20,80	2,1	
-	155	171	219,5	-	-	-	20,80	-	
-	135	141	158,8	-	-	-	2,60	-	
120	195,5	-	153,5	-	-	-	5,70	-	
	-	143,5	-	186,9	-	-	5,70	-	
	-	143,5	-	187,4	-	-	6,40	-	
	-	143,5	-	187,4	-	-	6,40	-	
	-	143,5	153,5	186,9	11	17	HJ224 E	5,70	0,72
	-	143,5	152	187,4	11	17	HJ224 E	6,50	0,72
	-	143,5	153,5	186,9	-	-	-	5,70	-
	-	143,5	-	186,9	-	-	-	8,30	-
	-	143,5	153,5	186,9	11	20	HJ2224 E	8,30	0,75
	-	143,5	152	181	11	20	HJ2224 E	9,30	0,75
	-	143,5	153,5	186,9	-	-	-	8,30	-

Single row cylindrical roller bearings

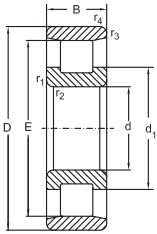

N

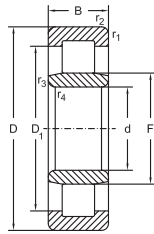

NU

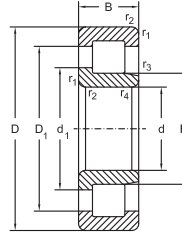

NJ

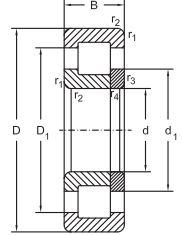

NUP

Dimensions						Basical radial load		Speed limit		Designation
d	D	B	r_1, r_2 min.	r_3, r_4 min.	s \approx	dyn. C_r	stat. C_{10}	grease	oil	
mm						kN		min^{-1}		
120	260	55	3	3	3,7	520	600	2200	2800	N324 E
	260	55	3	3	3,7	520	600	2200	2800	NU324 E
	260	55	3	3	3,7	520	600	2200	2800	NU324 EM
	260	55	3	3	-	520	600	2200	2800	NJ324 E
	260	55	3	3	-	520	600	2200	2800	NJ324 EM
	260	55	3	3	-	520	600	2200	2800	NUP324 E
	260	55	3	3	-	520	600	2200	2800	NUP324 EM
	260	86	3	3	7,2	780	1020	2000	2600	NU2324 EM
	260	86	3	3	-	780	1020	2000	2600	NJ2324 EM
	260	86	3	3	-	780	1020	2000	2600	NUP2324 EM
	310	72	5	5	6,3	670	780	1800	2200	N424 M
310	72	5	5	6,3	670	780	1800	2200	NU424 M	
310	72	5	5	-	670	780	1800	2200	NJ424 M	
310	72	5	5	-	673	770	1800	2200	NUP424 M	
130	200	33	2	1	4,7	180	250	3000	3600	NU1026 M
	200	33	2	2	-	180	250	3000	3600	NJ1026 M
	230	40	3	3	2,6	360	450	2400	3000	N226 E
	230	40	3	3	2,6	360	450	2400	3000	NU226 E
	230	40	3	3	2,6	360	450	2400	3000	NU226 EM
	230	40	3	3	-	360	450	2400	3000	NJ226 E
	230	40	3	3	-	360	450	2400	3000	NJ226 EM
	230	40	3	3	-	360	450	2400	3000	NUP226 E
	230	64	3	3	4,3	530	735	2400	3000	NU2226 E
	230	64	3	3	4,3	530	735	2400	3000	NU2226 EM
	230	64	3	3	-	530	735	2400	3000	NJ2226 E
	230	64	3	3	-	530	735	2400	3000	NUP2226 E
	280	58	4	4	3,7	570	670	2000	2600	N326 E
	280	58	4	4	3,7	570	670	2000	2600	NU326 E
	280	58	4	4	3,7	570	670	2000	2600	NU326 EM6
	280	58	4	4	-	570	670	2000	2600	NJ326 E
	280	58	4	4	-	570	670	2000	2600	NJ326 EM6
280	58	4	4	-	570	670	2000	2600	NUP326 E	
280	58	4	4	-	570	670	2000	2600	NUP326 EM6	

Single row cylindrical roller bearings

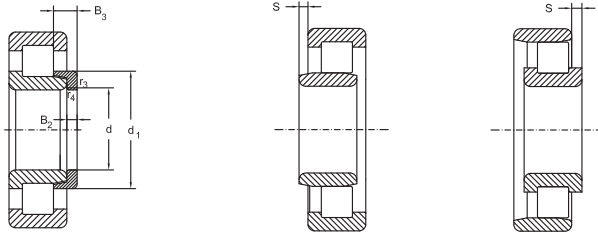

NJ+HJ

d	Dimensions						Thrust collar Designation	Mass	
	E	F	d_1 ≈	D_1 ≈	B_2	B_3		Bearing	Thrust collar
	mm							kg	
120	230	-	168,7	-	-	-	-	15,20	-
	-	154	-	217,3	-	-	-	13,40	-
	-	154	-	218,3	-	-	-	14,80	-
	-	154	168,7	217,3	14	22,5	HJ324 E	13,40	1,4
	-	154	168,3	218,3	14	22,5	HJ324 E	14,90	1,4
	-	154	168,7	217,3	-	-	-	13,40	-
	-	154	170	218,3	-	-	-	15,37	-
	-	154	-	217,3	-	-	-	23,50	-
	-	154	168,7	217,3	14	26	HJ2324 E	23,50	1,5
	-	154	168,7	217,3	-	-	-	23,50	-
130	260	-	188	-	-	-	-	29,60	-
	-	170	-	242,5	-	-	-	30,50	-
	-	170	188	242,5	17	30,5	HJ424	30,50	2,7
	-	170	188	240	-	-	-	31,30	-
	-	148	155	175	-	-	-	3,90	-
	-	148	154,8	175,2	8	16	HJ1026	4,20	0,45
	209,5	-	164,2	-	-	-	-	6,50	-
	-	153,5	-	200,2	-	-	-	6,50	-
	-	153,5	-	201,3	-	-	-	7,10	-
	-	153,5	164,2	200,2	11	17	HJ226 E	6,50	0,8
	-	153,5	164	201,3	11	17	HJ226 E	7,29	0,8
	-	153,5	164,2	200,2	-	-	-	6,50	-
	-	153,5	182,3	200,2	-	-	-	10,50	-
	-	153,5	-	193,7	-	-	-	11,48	-
	-	153,5	-	200,2	11	21	HJ2226 E	10,50	0,85
-	153,5	182,3	200,2	-	-	-	10,50	-	
247	-	182,3	-	-	-	-	16,50	-	
-	167	-	233,8	-	-	-	16,50	-	
-	167	-	235	-	-	-	18,50	-	
-	167	182,3	233,8	14	23	HJ326 E	16,50	1,7	
-	167	182,6	235	14	23	HJ326 E	18,65	1,7	
-	167	182,3	233,8	-	-	-	16,50	-	
-	167	182,7	235	-	-	-	20,15	-	

Single row cylindrical roller bearings

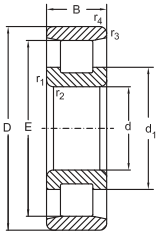

N

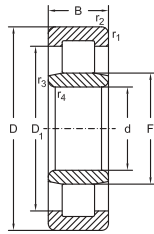

NU

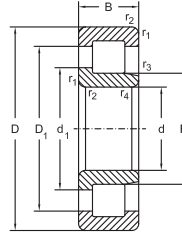

NJ

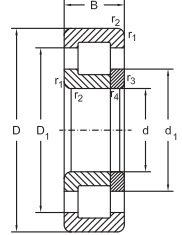

NUP

Dimensions						Basical radial load		Speed limit		Designation
d	D	B	r_1, r_2 min.	r_3, r_4 min.	s \approx	dyn. C_r	stat. C_{10}	grease	oil	
mm						kN		min^{-1}		
130	280	93	4	4	8,1	915	1220	1900	2400	NU2326 EM
	280	93	4	4	-	915	1220	1900	2400	NJ2326 EM
	280	93	4	4	-	915	1220	1900	2400	NUP2326 EM
	340	78	6	5	6,5	790	960	1800	2200	NU426 M
	340	78	6	5	-	790	960	1800	2200	NJ426 M
140	210	33	2	1,1	4,8	183	265	2800	3400	NU1028 M
	250	42	3	3	3,7	390	510	2400	3000	N228 EM
	250	42	3	3	3,7	390	510	2400	3000	NU228 EM
	250	42	3	3	-	390	510	2400	3000	NJ228 EM
	250	42	3	3	-	390	510	2400	3000	NUP228 EM
	250	68	3	3	4,4	570	830	2200	2800	NU2228 EM
	250	68	3	3	-	570	830	2200	2800	NJ2228 EM
	250	68	3	3	-	570	830	2200	2800	NUP2228 EM
	300	62	4	4	3,7	670	800	1900	2400	N328 E
	300	62	4	4	3,7	670	800	1900	2400	NU328 E
	300	62	4	4	3,7	670	800	1900	2400	NJ328 EM
	300	62	4	4	-	670	800	1900	2400	NJ328 E
	300	62	4	4	-	670	800	1900	2400	NJ328 M
	300	62	4	4	-	670	800	1900	2400	NUP328 E
	300	62	4	4	-	670	800	1900	2400	NUP328 EM
	300	102	4	4	9,2	1130	1589	1800	2200	NU2328 EM
	300	102	4	4	-	1130	1589	1800	2200	NJ2328 EM
	300	102	4	4	-	1130	1589	1800	2200	NUP2328 EM
360	82	6	5	7	850	1020	1600	1900	NU428 M	
360	82	6	5	-	850	1020	1600	1900	NJ428 M	
150	225	35	2,1	1,5	4,9	208	310	2600	3200	NU1030 M
	270	45	3	3	4	440	585	2200	2800	N230 EM
	270	45	3	3	4	440	585	2200	2800	NU230 EM
	270	45	3	3	-	440	585	2200	2800	NJ230 EM
	270	45	3	3	-	440	585	2200	2800	NUP230 EM
	270	73	3	3	4,3	655	980	2000	2600	NU2230 EM
	270	73	3	3	-	655	980	2000	2600	NJ2230 EM
270	73	3	3	-	655	980	2000	2600	NUP2230 EM	

Single row cylindrical roller bearings

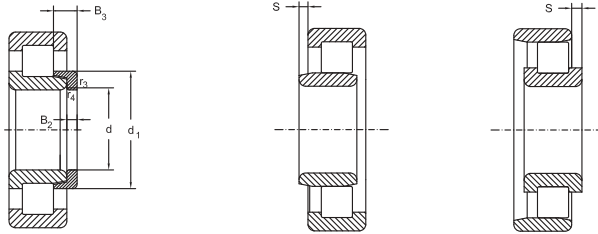

NJ+HJ

d	E	Dimensions					Thrust collar Designation	Mass	
		F	d_1 ≈	D_1 ≈	B_2	B_3		Bearing	Thrust collar
mm							kg		
130	-	167	-	233,8	-	-	-	29,60	-
	-	167	182,3	233,8	14	28	HJ2326 E	29,60	1,8
	-	167	182,3	233,8	-	-	-	29,60	-
	-	185	-	265	-	-	-	42,60	-
140	-	185	205	265	18	32	HJ426	42,60	3,4
	-	158	165	185	-	-	-	4,10	-
	225	-	180	-	-	-	-	9,50	-
	-	169	-	215,3	-	-	-	9,50	-
	-	169	180	215,3	11	18	HJ228 E	9,50	1
	-	169	180	215,3	-	-	-	9,50	-
	-	169	-	215,3	-	-	-	15,50	-
	-	169	180	215,3	11	23	HJ2228 E	15,50	1,1
	-	169	180	215,3	-	-	-	15,50	-
	264	-	195,5	-	-	-	-	22,50	-
	-	180	-	250,3	-	-	-	22,50	-
	-	180	-	251	-	-	-	21,36	-
	-	180	195,5	250,3	15	25	HJ328 E	22,50	2
	-	180	196	251	15	25	HJ328 E	22,21	2
	-	180	195,5	250,3	-	-	-	22,50	-
	-	180	196	251	-	-	-	23,04	-
	-	180	-	250,3	-	-	-	37,20	-
	-	180	195,5	250,3	15	31	HJ2328 E	37,20	2,2
-	180	195,5	250,3	-	-	-	37,20	-	
-	198	-	281	-	-	-	49,50	-	
-	198	219	281	18	33	HJ428	49,50	3,9	
150	-	169,5	176,5	198,1	-	-	-	5	-
	242	-	193,7	-	-	-	-	11,80	-
	-	182	-	231,8	-	-	-	11,80	-
	-	182	193,7	231,8	12	19,5	HJ230 E	11,80	1,3
	-	182	193,7	231,8	-	-	-	11,80	-
	-	182	-	231,8	-	-	-	19,50	-
	-	182	193,7	231,8	12	24,5	HJ2230 E	19,50	1,4
-	182	193,7	231,8	-	-	-	19,50	-	

Single row cylindrical roller bearings

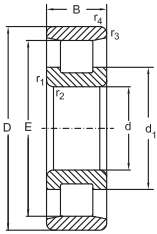

N

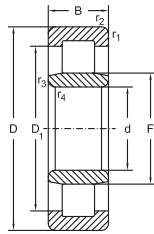

NU

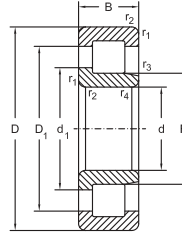

NJ

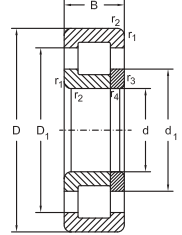

NUP

Dimensions						Basical radial load		Speed limit		Designation
d	D	B	r ₁ , r ₂ min.	r ₃ , r ₄ min.	s ≈	dyn. C _r	stat. C _{10r}	grease	oil	
mm						kN		min ⁻¹		
150	320	65	4	4	4	800	1000	1800	2200	N330 EM
	320	65	4	4	4	800	1000	1800	2200	NU330 EM
	320	65	4	4	-	800	1000	1800	2200	NJ330 EM
	320	65	4	4	-	800	1000	1800	2200	NUP330 EM
	320	108	4	4	9,8	1160	1600	1700	2000	NU2330 EM
	320	108	4	4	-	1160	1600	1700	2000	NJ2330 EM
	320	108	4	4	-	1160	1600	1700	2000	NUP2330 EM
	380	85	6	5	7,5	898	1145	1500	1800	NU430 M
380	85	6	5	-	898	1145	1500	1800	NJ430 M	
160	240	38	2,1	1,5	5,2	245	355	2400	3000	NU1032 M
	240	38	2,1	2,1	-	245	355	2400	3000	NJ1032 M
	290	48	3	3	4,1	500	670	2000	2600	N232 EM
	290	48	3	3	4,1	500	670	2000	2600	NU232 EM
	290	48	3	3	-	500	670	2000	2600	NJ232 EM
	290	48	3	3	-	500	670	2000	2600	NUP232 EM
	290	80	3	3	4,5	800	1180	1900	2400	NU2232 EM
	290	80	3	3	-	800	1180	1900	2400	NJ2232 EM
	290	80	3	3	-	800	1180	1900	2400	NUP2232 EM
	340	68	4	4	4	865	1060	1600	1900	N332 EM
	340	68	4	4	4	865	1060	1600	1900	NU332 EM
	340	68	4	4	-	865	1060	1600	1900	NJ332 EM
	340	68	4	4	-	865	1060	1600	1900	NUP332 EM
	340	114	4	4	10	1320	1830	1600	1900	NU2332 EM
340	114	4	4	-	1320	1830	1600	1900	NJ2332 EM	
340	114	4	4	-	1320	1830	1600	1900	NUP2332 EM	
170	260	42	2,1	2,1	5,8	300	430	2200	2800	NU1034 M
	260	42	2,1	2,1	-	300	430	2200	2800	NJ1034 M
	310	52	4	4	4,2	618	828	1800	2200	NU234 EM6
	310	52	4	4	-	618	828	1800	2200	NJ234 EM6
	310	52	4	4	-	618	828	1800	2200	NUP234 EM6
	310	86	4	4	4,2	950	1400	1700	2000	NU2234 EM
	310	86	4	4	-	950	1400	1700	2000	NJ2234 EM
	310	86	4	4	-	950	1400	1700	2000	NUP2234 EM

Single row cylindrical roller bearings

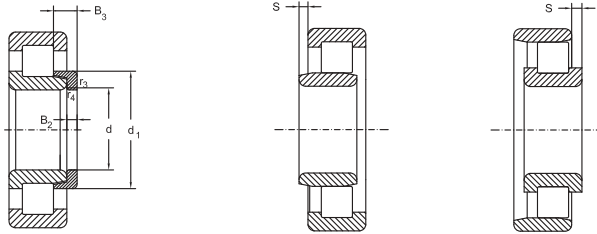

NJ+HJ

d	Dimensions						Thrust collar Designation	Mass	
	E	F	d_1 ≈	D_1 ≈	B_2	B_3		Bearing	Thrust collar
	mm							kg	
150	283	-	210,1	-	-	-	-	27,50	-
	-	193	-	268,4	-	-	-	27,50	-
	-	193	210,1	268,4	15	25	HJ330 E	27,50	2,4
	-	193	210,1	268,4	-	-	-	27,50	-
	-	193	-	268,4	-	-	-	44,80	-
	-	193	210,1	268,4	15	31,5	HJ2330 E	44,80	2,5
	-	193	210,1	268,4	-	-	-	44,80	-
160	-	213	-	296	-	-	-	48	-
	-	213	234	296	20	36,5	HJ430	48	4,9
	-	180	188	211,7	-	-	-	6,20	-
	-	180	188	210,3	10	19	HJ1032	6	0,75
	259	-	207,4	-	-	-	-	14,60	-
	-	195	-	248,2	-	-	-	14,60	-
	-	195	207,4	248,2	12	20	HJ232 E	14,60	1,5
	-	195	207,4	248,2	-	-	-	14,60	-
	-	193	-	249,7	-	-	-	24,50	-
	-	193	206,1	249,7	12	24,5	HJ2232 E	24,50	1,6
	-	193	206,1	249,7	-	-	-	24,50	-
	300	-	222,2	-	-	-	-	32,30	-
	-	204	-	284,6	-	-	-	32,30	-
	-	204	222,2	284,6	15	25	HJ332 E	32,10	2,7
-	204	222,2	284,6	-	-	-	32,10	-	
170	-	204	-	284,6	-	-	-	53,50	-
	-	204	222,2	284,6	15	32	HJ2332 E	53,50	2,9
	-	204	222,2	284,6	-	-	-	53,50	-
	-	193	200,9	227,7	-	-	-	8,40	-
	-	193	201,8	227,3	11	21	HJ1034	8,74	1
	-	207	-	267,1	-	-	-	18,20	-
	-	207	220,8	267,1	12	20	HJ232 E	18,20	1,7
	-	207	220,8	267,1	-	-	-	18,20	-
	-	205	-	268,5	-	-	-	29,80	-
-	205	219,6	268,5	12	24	HJ2234 E	29,80	1,8	
-	205	219,6	268,5	-	-	-	29,80	-	

Single row cylindrical roller bearings

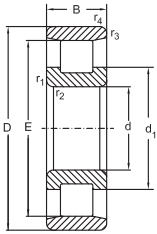

N

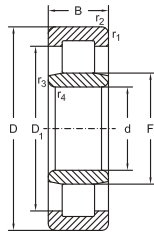

NU

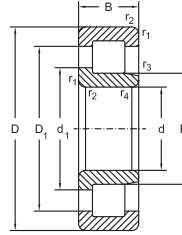

NJ

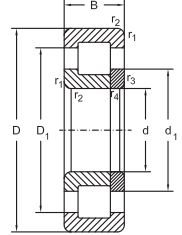

NUP

Dimensions						Basical radial load		Speed limit		Designation
d	D	B	r ₁ , r ₂ min.	r ₃ , r ₄ min.	s ≈	dyn. C _r	stat. C _{0r}	grease	oil	
mm						kN		min ⁻¹		
170	360	72	4	4	4,3	800	1020	1600	1900	N334 EM
	360	72	4	4	4,3	928	1150	1600	1900	NU334 EM
	360	72	4	4	-	928	1150	1600	1900	NJ334 EM
	360	72	4	4	-	928	1150	1600	1900	NUP334 EM
	360	120	4	4	10	1220	1760	1500	1800	NU2334 M
	360	120	4	4	-	1220	1760	1500	1800	NJ2334 M
180	360	120	4	4	-	1220	1760	1500	1800	NUP2334 M
	280	46	2,1	2,1	6,1	360	520	2200	2800	N1036 M
	280	46	2,1	2,1	6,1	360	520	2200	2800	NU1036 M
	280	46	2,1	2,1	-	360	520	2200	2800	NJ1036 M
	320	52	4	4	4,5	610	830	1800	2200	N236 EM
	320	52	4	4	4,5	610	830	1800	2200	NU236 EM
	320	52	4	4	-	610	830	1800	2200	NJ236 EM
	320	52	4	4	-	610	830	1800	2200	NUP236 EM
	320	86	4	4	4,2	1000	1500	1700	2000	NU2236 EM
	320	86	4	4	-	1000	1500	1700	2000	NJ2236 EM
	320	86	4	4	-	1000	1500	1700	2000	NUP2236 EM
	380	75	4	4	4,4	900	1160	1500	1800	N336 M
	380	75	4	4	4,4	900	1160	1500	1800	NU336 M
	380	75	4	4	-	900	1160	1500	1800	NJ336 M
	380	75	4	4	-	900	1160	1500	1800	NUP336 M
	380	126	4	4	10,5	1370	2000	1400	1700	NU2336 M
380	126	4	4	-	1370	2000	1400	1700	NJ2336 M	
380	126	4	4	-	1370	2000	1400	1700	NUP2336 M	
190	290	46	2,1	2,1	6,2	365	550	2000	2600	NU1038 M
	340	55	4	4	4,7	680	930	1700	2000	N238 EM
	340	55	4	4	4,7	680	930	1700	2000	NU238 EM
	340	55	4	4	-	680	930	1700	2000	NJ238 EM
	340	55	4	4	-	680	930	1700	2000	NUP238 EM
	340	92	4	4	5	854	1338	1600	1900	NU2238 EM
	340	92	4	4	-	854	1338	1600	1900	NJ2238 M
	400	78	5	5	4,5	1236	1635	1400	1700	NU338 EM
400	78	5	5	-	1236	1635	1400	1700	NJ338 EM	

Single row cylindrical roller bearings

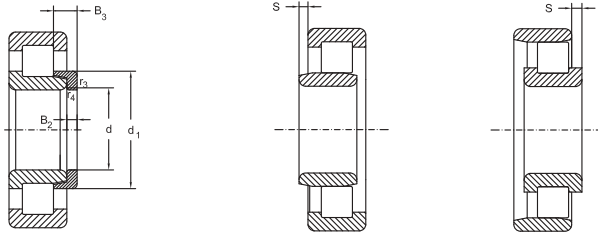

NJ+HJ

d	Dimensions						Thrust collar Designation	Mass	
	E	F	d_1 ≈	D_1 ≈	B_2	B_3		Bearing	Thrust collar
mm							kg		
170	310	-	238	-	-	-	-	38	-
	-	220	-	292,5	-	-	-	38	-
	-	220	238	292,5	16	29,5	HJ334 E	38	3,3
	-	220	238	292,5	-	-	-	38	-
	-	220	-	292,5	-	-	-	63,50	-
	-	220	238	292,5	16	38,5	HJ2334 E	63,50	3,7
180	-	220	238	292,5	-	-	-	63,50	-
	255	-	215	-	-	-	-	10,28	-
	-	205	214,1	244,7	-	-	-	10,90	-
	-	205	215	244	12	22,5	HJ1036	10,50	1,3
	289	-	230,2	-	-	-	-	18,90	-
	-	217	-	277,2	-	-	-	18,90	-
	-	217	230,2	277,2	12	20	HJ236 E	19	1,8
	-	217	230,2	277,2	-	-	-	19	-
	-	215	-	278,6	-	-	-	31,20	-
	-	215	229,6	278,6	12	24	HJ2236 E	31,20	1,9
	-	215	229,6	278,6	-	-	-	31,20	-
	328	-	252	-	-	-	-	44	-
	-	232	-	308,5	-	-	-	44	-
	-	232	252	308,5	17	30,5	HJ336 E	44	3,9
	-	232	252	308,5	-	-	-	44	-
-	232	-	308,5	-	-	-	74	-	
-	232	252	308,5	17	40	HJ2336 E	74	4,9	
-	232	252	308,5	-	-	-	74	-	
190	-	215	225	254,5	-	-	-	11,40	-
	306	-	244,6	-	-	-	-	22,80	-
	-	230	-	293,6	-	-	-	22,80	-
	-	230	244,6	293,6	13	21,5	HJ238 E	22,80	2,2
	-	230	244,6	293,6	-	-	-	22,80	-
	-	231	-	285,2	-	-	-	36,70	-
	-	231	246	285,2	13	26,5	HJ2238 E	37,60	2,4
	-	245	-	334,5	-	-	-	50,50	-
-	245	263,5	334,5	18	31	HJ338 E	50,50	4,5	

Single row cylindrical roller bearings

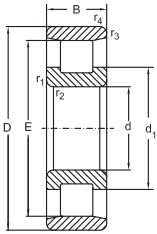

N

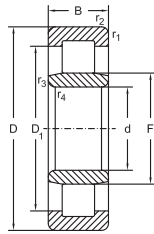

NU

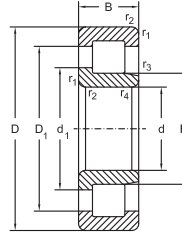

NJ

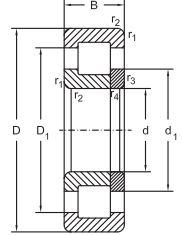

NUP

Dimensions						Basical radial load		Speed limit		Designation
d	D	B	r_{1, r_2} min.	r_{3, r_4} min.	s ≈	dyn. C_r	stat. C_{10}	grease	oil	
mm						kN		min^{-1}		
190	400	132	5	5	11	1789	1635	1400	1700	NU2338 EM6
	400	132	5	5	-	1789	2628	1400	1700	NJ2338 EM6
	400	132	5	5	-	1789	2628	1400	1700	NUP2338 EM6
200	310	51	2,1	2,1	7	400	600	2000	2600	NU1040 M
	310	51	2,1	2,1	-	400	600	2200	2800	NUP1040 M
	360	58	4	4	5	750	1040	1600	1900	N240 EM
	360	58	4	4	5	750	1040	1600	1900	NU240 EM
	360	58	4	4	-	750	1040	1600	1900	NJ240 EM
	360	58	4	4	-	750	1040	1600	1900	NUP240 EM
	360	98	4	4	5,1	1220	1860	1500	1800	NU2240 EM
	360	98	4	4	-	1220	1860	1500	1800	NJ2240 EM
	420	80	5	5	5	1300	1695	1400	1700	NU340 EM
	420	80	5	5	-	1300	1695	1400	1700	NJ340 M
	420	138	5	5	11,5	1740	2685	1300	1600	NU2340 M
220	420	138	5	5	-	1740	2685	1300	1600	NJ2340 M
	340	56	3	3	7,5	650	1047	1700	2000	NU1044 M
	340	56	5	5	-	650	1047	1700	2000	NJ1044 M
	400	65	4	4	6	778	1113	1500	1800	NU244 M
	400	65	4	4	-	778	1113	1500	1800	NJ244 M
	400	65	4	4	-	778	1113	1500	1800	NUP244 M
	400	108	4	4	6	1370	2310	1400	1700	NU2244 M
	400	108	4	4	-	1370	2310	1400	1700	NJ2244 M
240	460	88	5	5	5,2	1230	1650	1300	1600	NU344 M
	460	88	5	5	-	1230	1650	1300	1600	NUP344 M
	460	145	5	5	12	2015	3095	1200	1500	NU2344 E
	360	56	3	3	7,6	695	1168	1600	1900	NU1048 M
	440	72	4	4	6	936	1339	1400	1700	NU248 M
	440	72	4	4	-	936	1339	1400	1700	NJ248 M
	440	72	4	4	-	936	1339	1400	1700	NUP248 M
240	440	120	4	4	7	1430	2320	1300	1600	NU2248 M
	500	95	5	5	5,5	1400	1930	1200	1500	NU348 M
	500	155	5	5	8,5	2080	3150	1600	1900	NU2348 EM
260	400	65	4	4	8	660	1039	1500	1800	NU1052 M

Single row cylindrical roller bearings

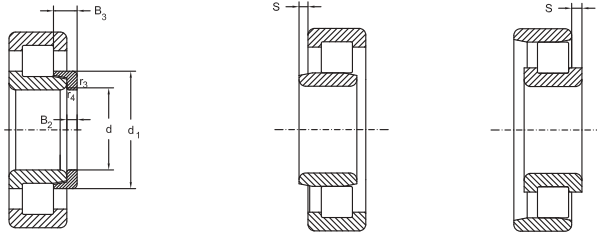

NJ+HJ

d	Dimensions						Thrust collar Designation	Mass	
	E	F	d_1 ≈	D_1 ≈	B_2	B_3		Bearing	Thrust collar
	mm							kg	
190	-	245	-	334,5	-	-	-	83,50	-
	-	245	263,5	334,5	18	36,5	HJ2338 E	83,50	5
	-	245	263,5	334,5	-	-	-	85,80	-
200	-	229	239,5	270,1	-	-	-	14,80	-
	-	229	239	270,8	-	-	-	14,90	-
	323	-	258,2	-	-	-	-	26,90	-
	-	243	-	310,1	-	-	-	26,90	-
	-	243	258,2	310,1	14	23	HJ240 E	26,90	2,6
	-	243	258,2	310,1	-	-	-	26,90	-
	-	241	-	311,5	-	-	-	45,70	-
	-	241	256,9	311,5	14	28	HJ2240 E	45,70	3
	-	260	-	348	-	-	-	60,80	-
	-	260	280	339,3	18	33	HJ340 E	57,50	5,2
	-	260	-	339,3	-	-	-	99	-
220	-	260	280	339,3	18	44,5	HJ2340 E	99	5,5
	-	250	262	297,3	-	-	-	19,30	-
	-	250	262	298	14	27	HJ1044	19,22	2,2
	-	270	-	334,3	-	-	-	38,10	-
	-	270	285,5	334,3	15	27,5	HJ244 E	38,10	3,6
	-	270	285,5	334,3	-	-	-	38,10	-
	-	270	-	334,3	-	-	-	63,50	-
	-	270	285,5	334,3	15	36,5	HJ2244 E	63,50	3,6
	-	284	-	373,3	-	-	-	75,50	-
240	-	284	307	373,6	-	-	-	77,17	-
	-	284	-	373,3	-	-	-	124	-
	-	270	282	317,3	-	-	-	20,70	2,4
	-	295	-	367,3	-	-	-	51,50	-
	-	295	313	367,3	16	29,5	HJ248 E	51,50	4,65
	-	295	313	366,4	-	-	-	52,13	-
	-	295	-	367,3	-	-	-	85,90	-
260	-	310	-	405,3	-	-	-	96,20	-
	-	299	-	419	-	-	-	148,40	-
	-	296	309,6	349,7	-	-	-	30,80	-

Single row cylindrical roller bearings

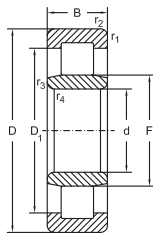

NU

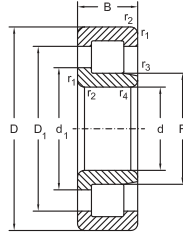

NJ

d	Dimensions					Basical radial load		Speed limit		Designation
	D	B	r_1, r_2 min.	r_3, r_4 min.	s \approx	dyn. C_r	stat. C_{10}	grease	oil	
	mm					kN		min^{-1}		
260	480	80	5	5	6,2	1140	1630	1200	1500	NU252 M
	480	80	5	5	-	1140	1630	1200	1500	NJ252 M
	480	130	5	5	7,2	1760	2900	1100	1400	NU252 M
	540	102	6	6	6	1600	2200	1100	1400	NU352 M
	540	165	6	6	9	2320	3550	1000	1300	NU2352 M
280	420	65	4	4	8,2	680	1100	1400	1700	NU1056 M
	500	80	5	5	6,2	1120	1660	1200	1500	NU256 M
	500	80	5	5	-	1120	1660	1200	1500	NJ256 M
	500	130	5	5	7,2	1760	2900	1100	1400	NU2256 M
	580	108	6	6	7	1800	2500	1000	1300	NU356 M
300	460	74	4	4	9,5	900	1430	1300	1600	NU1060 M
	460	74	4	4	-	900	1430	1300	1600	NJ1060 M
	540	85	5	5	7,2	1400	2040	1100	1400	NU260 M
	540	85	5	5	-	1400	2040	1100	1400	NJ260 M
	540	140	5	5	14	2080	3400	1000	1300	NU2260 M
	620	109	7,5	7,5	7,2	2080	3000	900	1100	NU360 M
320	480	74	4	4	9,7	915	1500	1200	1500	NU1064 M
	580	92	5	5	8,3	1600	2360	1000	1300	NU264 M
	580	92	5	5	-	1600	2360	1000	1300	NJ264 M
	440	56	3	3	-	655	1122	1000	1300	NJ1964 M
340	520	82	5	5	10	1120	1830	1200	1400	NU1068 M
360	540	82	5	5	10,2	1145	1900	1200	1400	NU1072 M
380	560	82	5	5	10,6	1180	2000	1000	1300	NU1076 M
400	600	90	5	5	12	1380	2368	950	1200	NU1080 M
	600	90	5	5	-	1400	2368	950	1200	NUP1080 M
	540	65	4	4	13,5	1161	2232	950	1200	NU1980 EM
420	620	90	5	5	14	1420	2450	900	1100	NU1084 M
440	650	94	6	6	14,7	1560	2750	850	1000	NU1088 M
460	680	100	6	6	15,9	1660	3000	850	1000	NU1092 M
480	650	78	5	5	16	1140	2240	900	1100	NU1996 M
	700	100	5	5	15,9	1680	3080	900	1100	NU1096 M
500	670	78	5	5	10	1140	2240	850	1000	NU19/500 M
	720	100	6	6	10,5	1760	3200	800	950	NU10/500 M

Single row cylindrical roller bearings

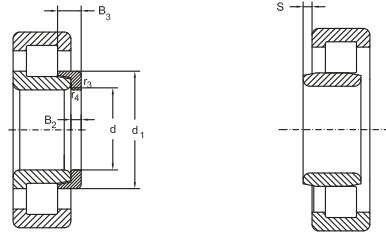

NJ+HJ

d	Dimensions						Thrust collar Designation	Mass	
	E	F	d_1 ≈	D_1 ≈	B_2	B_3		Bearing	Thrust collar
	mm							kg	
260	-	320	-	399,3	-	-	-	68,30	-
	-	320	340	399,3	18	33	HJ252 E	68,30	6,2
	-	320	-	399,3	-	-	-	112	-
	-	336	-	437,3	-	-	-	120	-
280	-	336	-	437,3	-	-	-	195	-
	-	316	329,6	369,7	-	-	-	32,80	-
	-	340	-	419,3	-	-	-	71,80	-
	-	340	360	419,3	18	33	HJ256 E	71,80	6,5
300	-	340	-	419,3	-	-	-	117	-
	-	362	-	469,3	-	-	-	147	-
	-	340	356	403,6	-	-	-	46,30	-
	-	340	356	403,6	19	36	HJ1060	45,90	5,4
	-	364	-	453,3	-	-	-	89,90	-
320	-	364	387	453,3	20	34,5	HJ260 E	89,90	8,4
	-	364	-	453,3	-	-	-	148	-
	-	388	-	506,7	-	-	-	168	-
	-	360	376	423,1	-	-	-	48,70	-
340	-	390	-	485,3	-	-	-	113	-
	-	390	415	485,3	21	37	HJ264 E	113	10,2
	-	348	360	400	19	36	HJ1964	26,10	5,5
340	-	385	403	456	-	-	-	65	-
360	-	405	423	476,4	-	-	-	68,20	-
380	-	425	-	496,7	-	-	-	71,20	-
400	-	450	-	529,5	-	-	-	92,50	-
	-	450	470	530	-	-	-	105,20	-
	-	435	-	495,8	-	-	-	44,02	-
420	-	470	-	549,5	-	-	-	96,20	-
440	-	493	-	575,7	-	-	-	110	-
460	-	516	-	601,5	-	-	-	129	-
480	-	525	-	587	-	-	-	77,50	-
	-	525	-	587	-	-	-	128	-
500	-	545	-	606,8	-	-	-	80,40	-
	-	556	-	641,7	-	-	-	139	-

Single row cylindrical roller bearings

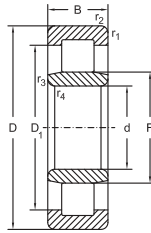

NU

d	Dimensions					Basical radial load		Speed limit		Designation
	D	B	r_1, r_2 min.	r_3, r_4 min.	s ≈	dyn. C_r	stat. C_{10}	grease	oil	
	mm					kN		min^{-1}		
560	750	85	5	5	7,5	1600	3200	750	900	NU19/560 M
	820	115	6	6	12,3	2300	4200	630	750	NU10/560 M
600	870	118	6	6	13,9	2750	5050	580	480	NU10/600 M
630	850	100	6	6	8,5	1900	3750	670	800	NU19/630 M
710	950	106	6	6	9,3	2080	4400	600	700	NU19/710 M

Single row cylindrical roller bearings

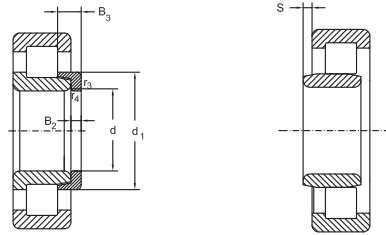

NJ+HJ

Dimensions							Thrust collar Designation	Mass	
d	E	F	d_1 ≈	D_1 ≈	B_2	B_3		Bearing	Thrust collar
mm							kg		
560	-	610	-	679,8	-	-	-	110	-
	-	626	-	713	-	-	-	215	-
600	-	667	-	779	-	-	-	240	-
630	-	688	-	768,5	-	-	-	169	-
710	-	774	-	860,6	-	-	-	219	-

ART **BEARINGS**



Double Row Cylindrical Roller Bearings

Standards, Boundary dimensions

Standard plans	DIN 616
Double row cylindrical roller bearings,	DIN 5412 / part 4

General

Double Row Cylindrical Roller Bearings of series NN30 and NNU 49 are separable radial bearings.

They are frequently used as non – locating bearings arrangements of working spindles for machine tools. Therefore, these bearings are often used in high precision tolerance class, frequently in combination with reduced internal clearance. These bearings also feature high radial load capacity and are satisfactory for high speed applications, providing a very stiff and rigid bearing arrangement. They are also commonly used with tapered bores, namely suffix K, (i.e. taper 1:12).

Design variants of Double Row Cylindrical Roller Bearings

Double Row Cylindrical Roller Bearings of series NN 30.. and NNU 49.. are produced and available either with or without tapered bores, as standard (see also figure below).

Bearings of series NN 30.. comprise of a plain outer ring and an inner ring with three integral shoulders to guide the two separate rows of rollers around the raceway. These bearings series are produced with lubrication facilities in their outer ring, such as a circumferential lubrication groove and holes as standard, name suffix W33.

Unlike the NN30.. series the double row cylindrical roller bearings of the NNU 49.. series feature opposite internal design characteristics, (i.e. outer ring with 3 integral shoulders around the raceway and a plain inner ring). These bearing series also feature lubrication facilities in their outer ring as standard, also namely, suffix W33.

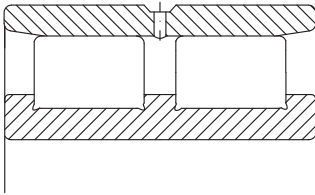

NN30..W33

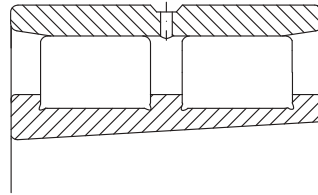

NN30..K..W33

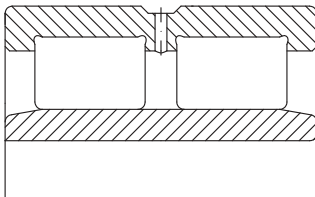

NNU49..W33

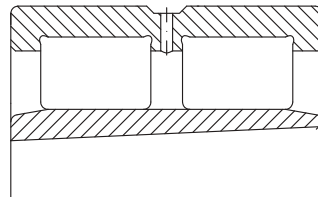

NNU49..K..W33

Cylindrical roller bearings of series NN30.. and NNU49.. allow for compensation of length changes within the bearings itself. In this way they are ideal non-locating bearings.

Both bearing rings may be mounted with heavy interference fit to shaft and housing.

Misalignment

Double Row Cylindrical Roller bearings are not able to accommodate misalignments.

Tolerances

Double Row Cylindrical Roller Bearings of series NN 30.. and NNU 49.. are frequently used as spindle bearings.

Consequently, they are also available with closer tolerance classes, such as P4 or SP, as standard.

On request these bearings are also produced to other tolerance classes.

Detailed tolerance values, for ART double row cylindrical roller bearings and ART double row cylindrical roller bearings in spindle bearing design, tolerance class SP, are listed in the table shown in the chapter "Bearing tolerances" page 25.

Cages

ART Double Row Cylindrical Roller Bearings of the series NN 30.. and NNU 49.. are produced with roller riding solid brass cages as standard.

Internal clearance

ART Double Row Cylindrical Roller Bearings are produced with normal internal clearance (clearance group CN, historically designated C0) as standard. Other internal radial clearances are produced upon order request.

NOTE:

ART Double Row Cylindrical Roller Bearings

of series NN 30.. and NNU 49.. produced to high precision design are frequently used with reduced internal radial clearance (clearance group C1).

As these bearings are produced to very closed tolerances, under no circumstances should components be mixed or exchanged with other bearing parts.

The value of internal clearance groups of ART Cylindrical Roller Bearings are listed in the tables on pages 155-156.

These Values conform, as far as they are standardised, and conform to DIN 620/part 4 and ISO 5753-1, respectively.

Minimum load

The minimum load applied to fast rotating double row cylindrical roller bearings should be higher than 4 % of its dynamic load rating C_r .

Equivalent Dynamic bearing load

Since double Row Cylindrical Roller Bearings of series NN 30.. and NNU 49.. are non – locating bearings, they are not able to accommodate any thrust loads.

$$P = F_r$$

Equivalent static bearing load

For Single and Double row cylindrical roller bearings:

$$P_0 = F_r$$

Mounting

When handling High Precision double row cylindrical roller bearings particular attention must be paid to the relevant instructions of fitting and mounting of these bearings.

When double row cylindrical roller bearings, with

tapered inner bores, are mounted the effect on the running clearance can be adjusted to obtain a specific clearance or preload.

As these bearing types are separable under no circumstances should either components or assembled bearings be mixed or exchanged with other bearing parts.

Abutment and fillet dimensions for Double row cylindrical roller bearings

The bearing rings must only contact adjacent parts with their side faces. The bearing corners must not touch the corner fillet radii or either the shaft or housing corners.

Therefore, the largest fillet radius (r_g) must be smaller than the minimum fillet dimension of the bearings rings (r_s) as listed in the bearing tables, also see next page.

Recommendations for the dimensions of adjacent parts are listed in **DIN 5418**.

Abutment and fillet dimensions for Double Row Cylindrical Roller Bearings

Dimensions are in [mm]

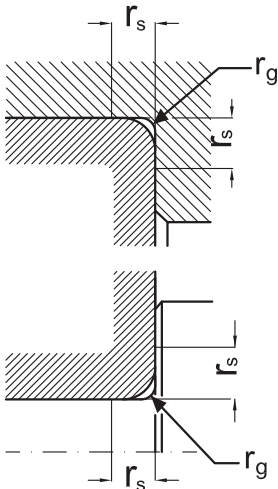

Abutment dimension for Double row Cylindrical Roller Bearings

All dimensions are in [mm]

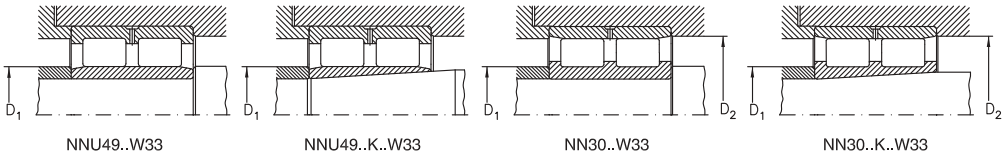

Shaft diameter d	for Bearings series					
	NNU49, NNU49 K		NN30, NN30 K			
	Type	D1 max	Type	D1 min	D2 min max	
mm						
30	-	-	NN3006	35	49	50
35	-	-	NN3007	40	56	57
40	-	-	NN3008	45	62	63
45	-	-	NN3009	50	69	70
50	-	-	NN3010	55	74	75
55	-	-	NN3011	61	82	84
60	-	-	NN3012	66	87	89
65	-	-	NN3013	71	92	94
70	-	-	NN3014	76	102	104
75	-	-	NN3015	81	107	109
80	-	-	NN3016	86	115	119
85	-	-	NN3017	91	120	124
90	-	-	NN3018	98	129	133
95	-	-	NN3019	103	134	137
100	NNU4920	112	NN3020	108	139	142
105	NNU4921	117	NN3021	114	148	151
110	NNU4922	122	NN3022	119	157	161
120	NNU4924	133	NN3024	129	167	171
130	NNU4926	145	NN3026	139	184	191
140	NNU4928	155	NN3028	149	194	201
150	NNU4930	167	NN3030	160	208	215
160	NNU4932	177	NN3032	170	222	230
170	NNU4934	187	NN3034	180	239	250
180	NNU4936	200	NN3036	190	258	270
190	NNU4938	210	NN3038	200	268	280
200	NNU4940	223	NN3040	210	285	300
220	NNU4944	243	NN3044	232	313	328
240	NNU4948	263	NN3048	252	334	348
260	NNU4952	289	NN3052	275	368	385
280	NNU4956	309	NN3056	295	388	405
300	NNU4960	335	NN3060	315	422	445
320	NNU4964	335	NN3064	335	442	465

ART **BEARINGS**

Double Row Cylindrical Roller Bearings

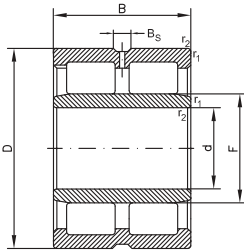

NUU49..W33

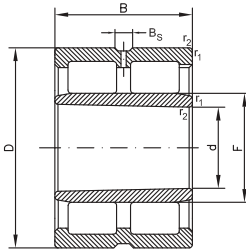

NUU49..K..W33

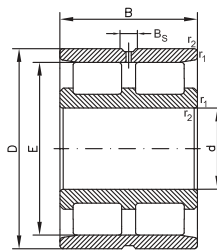

NN30..W33

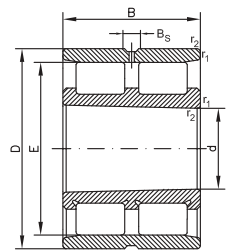

NN30..K..W33

Dimensions				Basical radial load		Speed limit		Designation
d	D	B	$r_{1,2}$ min.	dyn. C_r	stat. C_{0r}	grease	oil	
mm				kN		min ⁻¹		
30	55	19	1	29	34	16000	19000	NN3006 MW33
	55	19	1	29	34	16000	19000	NN3006 KMW33
35	62	20	1	39,3	50	14000	17000	NN3007 MW33
	62	20	1	39,3	50	14000	17000	NN3007 KMW33
40	68	21	1	45	58,5	12000	15000	NN3008 MW33
	68	21	1	45	58,5	12000	15000	NN3008 KMW33
45	75	23	1	54	72	11000	14000	NN3009 MW33
	75	23	1	54	72	11000	14000	NN3009 KMW33
50	80	23	1	57	80	10000	13000	NN3010 MW33
	80	23	1	57	80	10000	13000	NN3010 KMW33
55	90	26	1,1	72	100	9000	11000	NN3011 MW33
	90	26	1,1	72	100	9000	11000	NN3011 KMW33
60	95	26	1,1	75	110	8500	10000	NN3012 MW33
	95	26	1,1	75	110	8500	10000	NN3012 KMW33
65	100	26	1,1	76,5	118	8000	9500	NN3013 MW33
	100	26	1,1	76,5	118	8000	9500	NN3013 KMW33
70	110	30	1,1	98	151	7000	8500	NN3014 MW33
	110	30	1,1	98	151	7000	8500	NN3014 KMW33
75	115	30	1,1	100	156	6700	8000	NN3015 MW33
	115	30	1,1	100	156	6700	8000	NN3015 KMW33
80	125	34	1,1	120	186	6300	7500	NN3016 MW33
	125	34	1,1	120	186	6300	7500	NN3016 KMW33
85	130	34	1,1	125	200	6000	7000	NN3017 MW33
	130	34	1,1	125	200	6000	7000	NN3017 KMW33
90	140	37	1,5	141	224	5600	6700	NN3018 MW33
	140	37	1,5	141	224	5600	6700	NN3018 KMW33
95	145	37	1,5	146	236	5300	6300	NN3019 MW33
	145	37	1,5	146	236	5300	6300	NN3019 KMW33

Double Row Cylindrical Roller Bearings

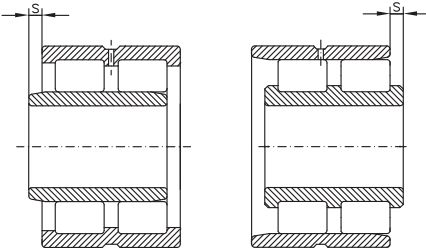

Bearing dimensions					Mass
d	E	F	B _s	s	
mm					[kg]
30	48,5	-	4,8	1,4	0,12
	48,5	-	4,8	1,4	0,12
35	55	-	4,8	1,4	0,25
	55	-	4,8	1,4	0,25
40	61	-	4,8	1,4	0,33
	61	-	4,8	1,4	0,32
45	67,5	-	4,8	1,7	0,39
	67,5	-	4,8	1,7	0,38
50	72,5	-	4,8	1,7	0,42
	72,5	-	4,8	1,7	0,41
55	81	-	4,8	1,9	0,62
	81	-	4,8	1,9	0,60
60	86,1	-	4,8	1,9	0,67
	86,1	-	4,8	1,9	0,65
65	91	-	4,8	1,9	0,73
	91	-	4,8	1,9	0,71
70	100	-	6,5	2,3	1,03
	100	-	6,5	2,3	0,99
75	105	-	6,5	2,3	1,08
	105	-	6,5	2,3	1,05
80	113	-	6,5	2,5	1,51
	113	-	6,5	2,5	1,46
85	118	-	6,5	2,5	1,55
	118	-	6,5	2,5	1,50
90	127	-	6,5	2,5	2,15
	127	-	6,5	2,5	2,09
95	132	-	6,5	2,5	2,10
	132	-	6,5	2,5	2,03

Double Row Cylindrical Roller Bearings

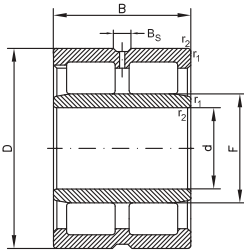

NNU49..W33

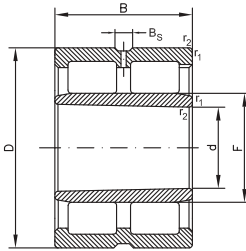

NNU49..K..W33

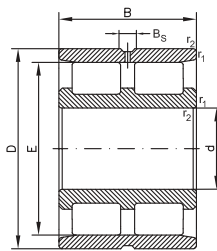

NN30..W33

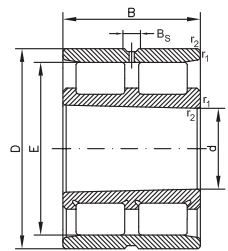

NN30..K..W33

Dimensions				Basical radial load		Speed limit		Designation
d	D	B	$r_{1,2}$ min.	dyn. C_r	stat. C_{0r}	grease	oil	
mm				kN		min ⁻¹		
100	140	40	1,1	129	255	5300	6300	NNU4920 MW33
	140	40	1,1	129	255	5300	6300	NNU4920 KMW33
	150	37	1,5	152	264	5300	6300	NN3020 MW33
	150	37	1,5	152	264	5300	6300	NN3020 KMW33
105	145	40	1,1	129	260	5300	6300	NNU4921 MW33
	145	40	1,1	129	260	5300	6300	NNU4921 KMW33
	160	41	2	192	310	4800	5600	NN3021 MW33
	160	41	2	192	310	4800	5600	NN3021 KMW33
110	150	40	1,1	132	270	5000	6000	NNU4922 MW33
	150	40	1,1	132	270	5000	6000	NNU4922 KMW33
	170	45	2	226	365	4500	5300	NN3022 MW33
	170	45	2	226	365	4500	5300	NN3022 KMW33
120	165	45	1,1	176	340	4500	5300	NNU4924 MW33
	165	45	1,1	176	340	4500	5300	NNU4924 KMW33
	180	46	2	235	405	4300	5000	NN3024 MW33
	180	46	2	235	405	4300	5000	NN3024 KMW33
130	180	50	1,5	193	390	4000	4800	NNU4926 MW33
	180	50	1,5	193	390	4000	4800	NNU4926 KMW33
	200	52	2	294	510	3800	4500	NN3026 MW33
	200	52	2	294	510	3800	4500	NN3026 KMW33
140	190	50	1,5	190	400	3800	4500	NNU4928 MW33
	190	50	1,5	190	400	3800	4500	NNU4928 KMW33
	210	53	2	305	520	3600	4300	NN3028 MW33
	210	53	2	305	520	3600	4300	NN3028 KMW33
150	210	60	2	326	655	3600	4300	NNU4930 MW33
	210	60	2	326	655	3600	4300	NNU4930 KMW33
	225	56	2	339	600	3400	4000	NN3030 MW33
	225	56	2	339	600	3400	4000	NN3030 KMW33

Double Row Cylindrical Roller Bearings

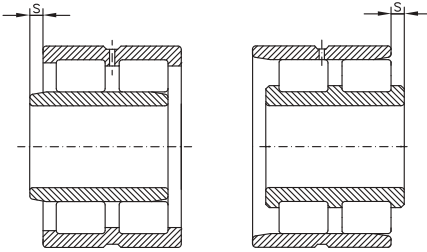

Bearing dimensions					Mass
d	E	F	B _s	s	
mm					[kg]
100	-	113	6,5	2	1,80
	-	113	6,5	2	1,72
	137	-	6,5	2,5	2,20
	137	-	6,5	2,5	2,13
105	-	118	6,5	1,5	2,07
	-	118	6,5	1,5	1,98
	146	-	6,5	2,6	2,84
	146	-	6,5	2,6	2,75
110	-	123	6,5	1,5	2,13
	-	123	6,5	1,5	2,04
	155	-	6,5	2,8	3,68
	155	-	6,5	2,8	3,56
120	-	134,5	6,5	1,5	2,76
	-	134,5	6,5	1,5	2,64
	165	-	6,5	3,1	3,96
	165	-	6,5	3,1	3,83
130	-	146	6,5	2	3,54
	-	146	6,5	2	3,37
	182	-	9,5	3,35	5,75
	182	-	9,5	3,35	5,57
140	-	156	6,5	2	4,24
	-	156	6,5	2	4,06
	192	-	9,5	3,35	6,38
	192	-	9,5	3,35	6,18
150	-	168,5	6,5	2,3	6,49
	-	168,5	6,5	2,3	6,21
	206	-	9,5	3,7	7,50
	206	-	9,5	3,7	7,26

Double Row Cylindrical Roller Bearings

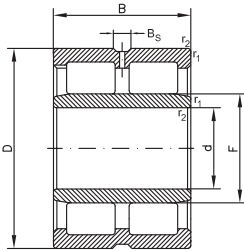

NNU49..W33

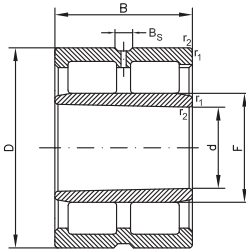

NNU49..K..W33

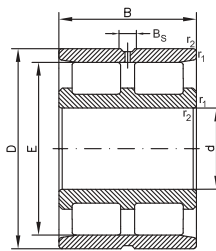

NN30..W33

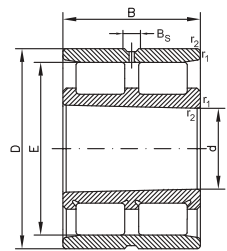

NN30..K..W33

Dimensions				Basical radial load		Speed limit		Designation
d	D	B	$r_{1,2}$ min.	dyn. C_r	stat. C_{0r}	grease	oil	
mm				kN		min ⁻¹		
160	220	60	2	335	680	3400	4000	NNU4932 MW33
	220	60	2	335	680	3400	4000	NNU4932 KMW33
	240	60	2,1	388	670	3200	3800	NN3032 MW33
	240	60	2,1	388	670	3200	3800	NN3032 KMW33
170	230	60	2	340	720	3200	3800	NNU4934 MW33
	230	60	2	340	720	3200	3800	NNU4934 KMW33
	260	67	2,1	458	810	3000	3600	NN3034 MW33
	260	67	2,1	458	810	3000	3600	NN3034 KMW33
180	250	69	2	405	877	3000	3600	NNU4936 MW33
	250	69	2	405	877	3000	3600	NNU4936 KMW33
	280	74	2,1	576	1080	2800	3400	NN3036 MW33
	280	74	2,1	576	1080	2800	3400	NN3036 KMW33
190	260	69	2	412	910	2800	3400	NNU4938 MW33
	260	69	2	412	910	2800	3400	NNU4938 KMW33
	290	75	2,1	614	1088	2600	3200	NN3038 MW33
	290	75	2,1	614	1088	2600	3200	NN3038 KMW33
200	280	80	2,1	490	1040	2600	3200	NNU4940 MW33
	280	80	2,1	490	1040	2600	3200	NNU4940 KMW33
	310	82	2,1	715	1271	2400	3000	NN3040 MW33
	310	82	2,1	715	1271	2400	3000	NN3040 KMW33
220	300	80	2,1	535	1321	2400	3000	NNU4944 MW33
	300	80	2,1	535	1321	2400	3000	NNU4944 KMW33
	340	90	3	890	1591	2200	2800	NN3044 MW33
	340	90	3	890	1591	2200	2800	NN3044 KMW33
240	320	80	2,1	556	1300	2200	2800	NNU4948 MW33
	320	80	2,1	556	1300	2200	2800	NNU4948 KMW33
	360	92	3	850	1560	2000	2600	NN3048 MW33
	360	92	3	850	1560	2000	2600	NN3048 KMW33

Double Row Cylindrical Roller Bearings

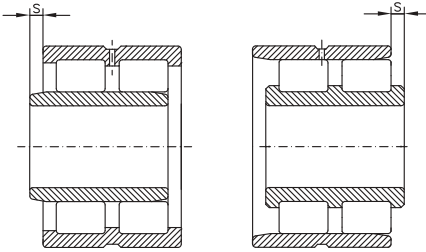

Bearing dimensions					Mass
d	E	F	B _s	s	
mm					[kg]
160	-	178,5	6,5	2,3	6,67
	-	178,5	6,5	2,3	6,37
	219	-	9,5	4,2	9,42
	219	-	9,5	4,2	9,12
170	-	188,5	6,5	2,3	7,16
	-	188,5	6,5	2,3	6,85
	236	-	9,5	4,5	12,8
	236	-	9,5	4,5	12,4
180	-	202	9,5	2,6	10,6
	-	202	9,5	2,6	10,1
	255	-	12,2	4,8	16,9
	255	-	12,2	4,8	16,3
190	-	212	9,5	2,6	10,6
	-	212	9,5	2,6	10,1
	265	-	12,2	4,8	17,6
	265	-	12,2	4,8	17,1
200	-	225	12,2	3,4	16,5
	-	225	12,2	3,4	15,9
	282	-	12,2	5,3	23,1
	282	-	12,2	5,3	22,4
220	-	245	12,2	3,4	16,8
	-	245	12,2	3,4	16,1
	310	-	15	4,5	29,2
	310	-	15	4,5	28,2
240	-	265	12	3,4	18,0
	-	265	12	3,4	17,2
	330	-	15	6	31,9
	330	-	15	6	30,8

Double Row Cylindrical Roller Bearings

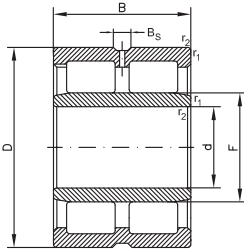

NNU49..W33

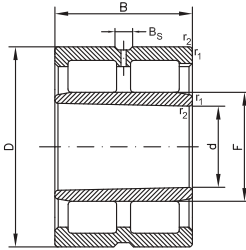

NNU49..K..W33

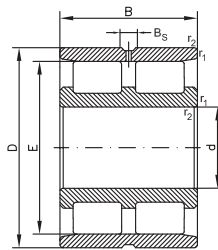

NN30..W33

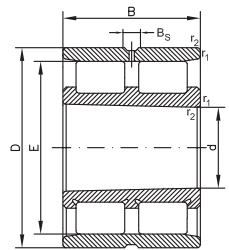

NN30..K..W33

Dimensions				Basical radial load		Speed limit		Designation
d	D	B	$r_{1,2}$ min.	dyn. C_r	stat. C_{0r}	grease	oil	
mm				kN		min ⁻¹		
260	360	100	2,1	750	1700	2000	2600	NNU4952 MW33
	360	100	2,1	750	1700	2000	2600	NNU4952 KMW33
	400	104	4	1060	2000	1900	2400	NN3052 MW33
	400	104	4	1060	2000	1900	2400	NN3052 KMW33
280	380	100	2,1	765	1800	1900	2400	NNU4956 MW33
	380	100	2,1	765	1800	1900	2400	NNU4956 KMW33
	420	106	4	1080	2080	1800	2200	NN3056 MW33
	420	106	4	1080	2080	1800	2200	NN3056 KMW33
300	420	118	3	1188	2943	1700	2000	NNU4960 MW33
	420	118	3	1188	2943	1700	2000	NNU4960 KMW33
	460	118	4	1270	2400	1600	1900	NN3060 MW33
	460	118	4	1270	2400	1600	1900	NN3060 KMW33
320	440	118	3	1060	2550	1600	1900	NNU4964 KMW33
	480	121	4	1320	2600	1600	1900	NN3064 MW33
380	520	140	4	1705	4620	1100	1300	NNU4976 MW33
	520	140	4	1705	4620	1100	1300	NNU4976 KMW33
420	560	140	4	1786	5067	1000	1200	NNU4984 MW33
	560	140	4	1786	5067	1000	1200	NNU4984 KMW33

Double Row Cylindrical Roller Bearings

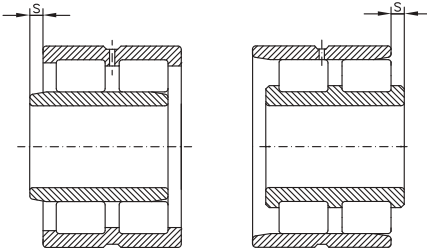

Bearing dimensions					Mass
d	E	F	B _s	s	
mm					[kg]
260	-	292	15	4	31,3
	-	292	15	4	29,9
	364	-	15	6,5	47,4
	364	-	15	6,5	45,9
280	-	312	15	4	32,7
	-	312	15	4	31,2
	384	-	15	6,75	51,2
	384	-	15	6,75	49,5
300	-	339	17,7	5	52,3
	-	339	17,7	5	50,1
	418	-	17,7	7,45	71,2
	418	-	17,7	7,45	69,1
320	-	359	17,7	5	52,6
	438	-	17,7	7,95	76,8
380	-	426	19,7	5,5	91,9
	-	426	19,7	5,5	88,1
420	-	466	19,7	5,5	96,3
	-	466	19,7	5,5	92,1

ART
BEARINGS



Tapered roller bearings

Tapered roller bearings have the rolling elements under the form of a frustum of a cone.

They roll on tapered surfaces which, if it's extended, converge towards a single point on the bearing axis.

The rollers are guided tangentially by the cage and axially by the big rib of the outer ring, on which they have point contact. As between roller and raceways there is linear contact, tapered roller bearings can take heavy radial loads. They can also take heavy axial or combined loads, depending on the contact angle caused by the tapered rolling elements. The

contact angle is the angle of the outer raceway generatrix.

Constructive versions for single row tapered roller bearings:

- single row

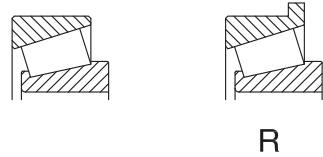

Suffixes

- A** - increased basic load
- B** - enlarged contact angle
- F** - machined cage of hardened steel or special cast iron
- F2** - constructive modifications
- J** - pressed cage of not hardened steel sheet
- K** - tapered bore 1:12
- M** - machined brass cage

P6X - tolerance class with smaller values than normal

P5 - tolerance class with smaller values than P6X

P4 - tolerance class with smaller values than P5

P2 - tolerance class with smaller values than P4

R - rib on the outer ring

S0 - operating temperature up to +150°C

S1 - operating temperature up to +200°C

TN - polyamide cage

X - modified main dimensions according to ISO

Single row tapered roller bearings

Single row tapered roller bearings are of separable design, i.e. the outer ring and the inner ring with rollers and cage assembly can be separately mounted. These two assemblies are interchangeable.

Tapered roller bearings can be manufactured both in standardized constructive versions with dimensions series 320, 302, 322, 303, 323, 313 and with non-standardized dimensions, mm or inch.

Tapered roller bearings can carry only single direction axial loads. Under pure radial loads, an axial force occurs which is supposed to distance the bearing ring in axial direction.

Therefore, tapered roller bearings are generally pair mounted on both ends of the shaft, in "X" or "O"

arrangements, so that the shaft will be axially located in both directions (table 3). Thus, the optimum clearance in these two bearings can be adjusted.

Single row tapered roller bearings can also be manufactured with rib on the outer ring. This design is to be used when the housing cannot be manufactured with shoulder, but only with a passed through bore. In this case, axial location can be provided by the bearing ring.

Permissible values of misalignment between shaft and housing are given in table 1, depending on bearing size and load magnitude.

Tolerances

Tapered roller bearings are generally manufactured

Permissible misalignment Table 1		
Bearings series	Load magnitude	Permissible misalignment
329, 320, 330, 331, 302, 322, 332, 313, 303	$F/C_{or} < 0,1$ $F_r/C_{or} > 0,1$	2' 4'
323	$F/C_{or} < 0,1$ $F_r/C_{or} > 0,1$	1'30" 3'

to the normal tolerance class ISO and AFBMA, respectively (for bearings with inch dimensions).

For certain applications (e.g. bearings for machine-tools), they can be also manufactured to tolerance classes P5 and P6X or 3 AFBMA.

At request, they can be manufactured to tolerance class P4.

Single row tapered roller bearings have the outer rings interchangeable with the inner ring - rollers - cage assembly (if they have the same mark) and also with bearings produced by other companies, according to ISO and AFBMA respectively.

The tolerances for bearings overall dimensions are given in tables on the pages 34-38 for tapered roller bearings, both with metric and inch dimensions. Tolerances for mounting chamfer are given in tables on page 42.

Cages

Small and medium-sized tapered roller bearings are generally fitted with pressed sheet cages. Large

sized bearings are generally fitted with machined steel or brass cages, with welded pins. In some cases, median or large sized bearings can also be fitted with machined steel or brass cages. In all cases, the cage is guided on rollers.

For small and medium sized bearings, glass fibre reinforced polyamide 6.6 cages can be successfully used if the operating temperature doesn't exceed +120°C. They have low mass, are noiseless in operation and have low coefficient of friction.

Design and some technical data are given in table 2.

Equivalent dynamic radial load

Equivalent dynamic radial load can be calculated using the following equations:

$$P_r = F_r, \text{ kN,} \quad \text{when } F_a/F_r \leq e$$

$$P_r = 0,4 F_r + YF_a, \text{ kN,} \quad \text{when } F_a/F_r > e$$

Fa values can be calculated using the equations in table 3.

These equations are available when bearings are mounted so that axial clearance is in fact zero without preloading. F_{rA} and F_{rB} should always be considered as being positive, even if they act in the opposite direction to that in the figure.

The values of e, Y are given in bearing tables.

Cage design and some technical data Table 2						
Cage	Design			Application	Max. value $D_m n$	
	bearing	cage			oil	grease
Pressed sheet cage				- General application - Small and medium sized bearings $d \leq 250$ mm	350x10 ³	245x10 ³
Machined brass cage M				- General application - Median and large sized bearings $d > 150$ mm	450x10 ³	315x10 ³

Equivalent static radial load

Equivalent static radial load can be calculated using the equations:

$$P_{0r} = F_{r1} \text{ kN,} \quad \text{when } F_a/F_r \leq 1/2 Y_0$$

$$P_{0r} = 0,5 F_r + Y_0 F_a \text{ kN,} \quad \text{when } F_a/F_r > 1/2 Y_0$$

F_a is calculated as in case of equivalent dynamic

radial load. The values of Y_0 are given in bearing tables.

Abutment dimensions

The mounting dimensions of tapered roller bearings are given in the bearings tables, for single row tapered roller bearings. These dimensions are also available for bearings with ribs.

Calculating relations for axial loadings F_a		Table 3	
		Loading versions	Axial load
	1a) $\frac{F_{rA}}{Y_A} \geq \frac{F_{rB}}{Y_B}$ $K_a \geq 0$	$F_{aA} = \frac{0,5F_{rA}}{Y_A}$ $F_{aB} = F_{aA} + K_a$	
	1b) $\frac{F_{rA}}{Y_A} < \frac{F_{rB}}{Y_B}$ $K_a \geq 0,5 \left(\frac{F_{rB}}{Y_B} - \frac{F_{rA}}{Y_A} \right)$	$F_{aA} = \frac{0,5F_{rA}}{Y_A}$ $F_{aB} = F_{aA} + K_a$	
	1c) $\frac{F_{rA}}{Y_A} < \frac{F_{rB}}{Y_B}$ $K_a < 0,5 \left(\frac{F_{rB}}{Y_B} - \frac{F_{rA}}{Y_A} \right)$	$F_{aA} = F_{aB} - K_a$ $F_{aB} = \frac{0,5F_{rB}}{Y_B}$	
	2a) $\frac{F_{rA}}{Y_A} \leq \frac{F_{rB}}{Y_B}$ $K_a \geq 0$	$F_{aA} = F_{aB} + K_a$ $F_{aB} = \frac{0,5F_{rB}}{Y_B}$	
	2b) $\frac{F_{rA}}{Y_A} > \frac{F_{rB}}{Y_B}$ $K_a \geq 0,5 \left(\frac{F_{rA}}{Y_A} - \frac{F_{rB}}{Y_B} \right)$	$F_{aA} = F_{aB} + K_a$ $F_{aB} = \frac{0,5F_{rB}}{Y_B}$	
	2c) $\frac{F_{rA}}{Y_A} > \frac{F_{rB}}{Y_B}$ $K_a < 0,5 \left(\frac{F_{rA}}{Y_A} - \frac{F_{rB}}{Y_B} \right)$	$F_{aA} = \frac{0,5F_{rA}}{Y_A}$ $F_{aB} = F_{aA} - K_a$	

Tapered roller bearings, single row

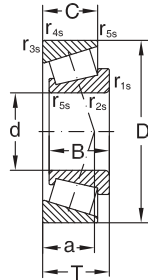

Dimensions									Designation	ISO series	Basic radial load. Factors				
d	D	B	C	T	r _{1s,2s} min.	r _{3s,4s} min.	r ₅ min.	a			dyn. C _r	e	Y	stat C _{0r}	Y ₀
mm											kN	-	-	kN	-
15	35	11	10	11,75	0,6	0,6	0,3	8,2	30202 A	-	14,8	0,32	1,9	13,2	1
	42	13	11	14,25	1	1	0,3	9	30302 A	2FB	21,5	0,28	2,1	19,8	1,1
17	40	12	11	13,25	1	1	0,3	10	30203 A	2DB	18,3	0,35	1,7	19	0,9
	40	16	14	17,25	1	1	0,3	11,2	32203 A	2DD	27	0,31	1,9	28	1,1
	47	14	12	15,25	1	1	0,3	10	30303 A	2FB	26	0,28	2,1	24,5	1,1
20	47	19	16	20,25	1	1	0,3	12	32303 A	2FD	34	0,28	2,1	35,5	1,1
	42	15	12	15	0,6	0,6	0,3	10	32004 XA	3CC	26	0,37	1,6	28,5	0,9
	47	14	12	15,25	1	1	0,3	11	30204 A	2DB	25,8	0,35	1,7	26,4	0,9
	47	18	15	19,25	1	1	0,3	12,5	32204 A	2DD	30	0,33	1,8	35	1
	52	15	13	16,25	1,5	1,5	0,6	11	30304 A	2FB	32	0,3	2	32	1,1
	52	21	18	22,25	1,5	1,5	0,6	14	32304 A	2FD	42,5	0,3	2	47	1,1
25	47	15	11,5	15	0,6	0,6	0,3	11	32005 XA	4CC	26	0,43	1,4	33,5	0,8
	47	17	14	17	0,6	0,6	0,3	11	33005	2CE	31	0,29	2,1	38	1,1
	52	15	13	16,25	1	1	0,3	12	30205 A	3CC	30,1	0,37	1,6	32,9	0,9
	52	18	15	19,25	1	1	0,3	16	32205 A	2CD	31	0,33	1,8	37	1
	52	22	18	22	1	1	0,3	14	33205	2DE	48,5	0,35	1,71	58	0,94
	62	17	15	18,25	1,5	1,5	0,6	13	30305 A	2FB	43	0,3	2	43	1,1
30	62	17	13	18,25	1,5	1,5	0,6	20	31305 A	7FB	39	0,83	0,7	41	0,4
	62	24	20	25,25	1,5	1,5	0,6	15	32305 A	2FD	58,3	0,3	2	60,3	1,1
	55	17	13	17	1	1	0,3	13	32006 XA	4CC	34	0,43	1,4	45,5	0,8
	55	20	16	20	1	1	0,3	13,1	33006	2CE	42	0,29	2,1	54	1,1
	62	16	14	17,25	1	1	0,3	14	30206 A	3DB	40,5	0,37	1,6	45,1	0,9
	62	20	17	21,25	1	1	0,3	15	32206 A	3DC	49	0,37	1,6	61	0,9
	62	25	19,5	25	1	1	0,3	16	33206	2DE	65	0,34	1,76	77	0,97
	72	19	16	20,75	1,5	1,5	0,6	15	30306 A	2FB	52,9	0,37	1,9	51,8	1,1
35	72	19	14	20,75	1,5	1,5	0,6	22	31306 A	7FB	46,5	0,31	0,7	49,5	0,4
	72	27	23	28,75	1,5	1,5	0,6	18	32306 A	2FD	75,8	0,83	1,9	82,7	1,1
	62	18	14	18	1	1	0,3	15	32007 XA	4CC	35,9	0,31	1,3	52,4	0,7
	62	21	17	21	1	1	0,3	14,1	33007	2CE	49	0,31	2	65	1,1
	72	17	15	18,25	1,5	1,5	0,6	15	30207 A	3DB	50,5	0,46	1,6	54,7	0,9
	72	23	19	24,25	1,5	1,5	0,6	17	32207 A	3DC	66,2	0,37	1,6	77,5	0,9
	72	28	22	28	1,5	1,5	0,6	18	33207	2DE	86	0,35	1,7	105	0,93
	80	21	18	22,75	2	1,5	0,6	16	30307 A	2FB	71,2	0,37	1,9	72,5	1,1
	80	21	15	22,75	2	1,5	0,6	25	31307 A	7FB	58,1	0,31	0,7	64	0,4
	80	31	25	32,75	2	1,5	0,6	20	32307 A	2FE	95,3	0,83	1,9	106	1,1
40	68	19	14,5	19	1	1	0,3	15	32008 XA	3CD	48,8	0,31	1,6	65,6	0,9
	68	22	18	22	1	1	0,3	14,6	33008	2BE	59	0,28	2,1	81,5	1,2
	75	26	20,5	26	1,5	1,5	0,3	18	33108	2CE	79	0,36	1,69	103	0,93
	80	18	16	19,75	1,5	1,5	0,6	16	30208 A	3DB	57,9	0,37	1,6	62,4	0,9
	80	23	19	24,75	1,5	1,5	0,6	19	32208 A	3DC	66,2	0,37	1,6	79,5	0,9

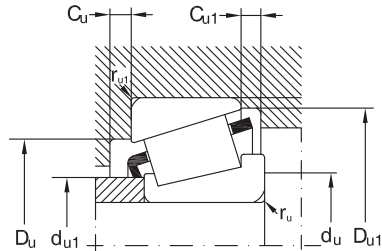

Speed limit		Mass	Mounting dimensions								
grease	oil		du1 max.	du min.	Du		Du1 min.	Cu min.	Cu1 min.	ru max.	ru1 max.
					min.	max.					
min ⁻¹		Kg									
11000	15000	0,05	19	23	30	30	33	2	1,5	0,6	0,6
9000	13000	0,09	22	21	36	36	38	2	3	1	1
9000	13000	0,074	23	23	34	34	37	2	2	1	1
9000	13000	0,11	22	26	34	34	37	2	3	1	1
8500	12000	0,13	25	23	40	41	42	2	3	1	1
8000	11000	0,17	24	23	39	41	43	3	4	1	1
8500	12000	0,097	25	25	36	37	39	3	3	0,6	0,6
8000	11000	0,12	27	26	40	41	43	2	3	1	1
8500	11000	0,16	25	29	38	41	44,5	3	4	1	1
8000	11000	0,17	28	27	44	45	47	2	3	1,5	1,5
7500	10000	0,221	27	27	43	45	47	3	4	1,5	1,5
8000	11000	0,113	30	30	40	42	44	3	3,5	0,6	0,6
8000	11000	0,13	29	33	41	42	44	3	3	0,6	0,6
7500	10000	0,15	31	31	44	46	48	2	3	1	1
7500	10000	0,182	31	31	44	46	48	3	4	1	1
7500	10000	0,214	30	31	43	46	49	4	4	1	1
6700	9000	0,25	34	32	54	55	57	2	3	1,5	1,5
5600	7500	0,255	34	32	47	55	59	3	5	1,5	1,5
6000	8000	0,36	33	32	53	55	57	3	5	1,5	1,5
6700	9000	0,017	35	36	48	49	52	3	4	1	1
6700	9000	0,21	35	39	48	49	52	3	4	1	1
6300	8500	0,22	35	36	53	56	57	2	3	1	1
6300	8500	0,28	37	36	52	56	59	3	4	1	1
6300	8500	0,39	36	36	53	56	59	5	5,5	1	1
5600	7500	0,38	37	37	62	65	66	3	4,5	1,5	1,5
5000	6700	0,39	40	37	55	65	68	3	6,5	1,5	1,5
5300	7000	0,55	40	37	59	65	66	4	5,5	1,5	1,5
6000	8000	0,22	39	41	54	56	59	4	4	1	1
6000	8000	0,27	40	44	55	56	59	4	4	1	1
5300	7000	0,32	40	42	62	65	67	3	3	1,5	1,5
5300	7000	0,42	44	42	61	65	67	3	5,5	1,5	1,5
5300	7000	0,58	42	42	61	65	68	5	6	1,5	1,5
5000	6700	0,52	43	44	70	71	74	3	4,5	2	1,5
4500	6000	0,52	45	44	62	71	76	4	7,5	2	1,5
4800	6300	0,73	44	44	66	71	74	4	7,5	2	1,5
5300	7000	0,27	44	46	60	62	65	4	4,5	1	1
5300	7000	0,32	45	49	61	62	65	4	4	1	1
5300	7000	0,54	47	47	65	68	71	4	5,5	1,5	1,5
4800	6300	0,42	46	47	69	73	74	3	3,5	1,5	1,5
4800	6300	0,51	49	47	68	73	75	3	5,5	1,5	1,5

Tapered roller bearings, single row

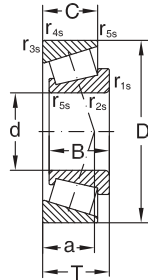

Dimensions									Designation	ISO series	Basic radial load. Factors				
d	D	B	C	T	r _{1s,2s} min.	r _{3s,4s} min.	r ₅ min.	a			dyn. C _r	e	Y	stat C _{0r}	Y ₀
mm											kN	-	-	kN	-
40	80	32	25	32	1,5	1,5	0,6	21	33208	2DE	105	0,36	1,68	134	0,92
	90	23	20	25,25	2	1,5	0,6	19	30308 A	2FB	83,9	0,37	1,7	91,3	0,9
	90	23	17	25,25	2	1,5	0,6	28	31308 A	7FB	74,6	0,83	0,7	60,8	0,4
	90	33	27	35,25	2	1,5	0,6	23	32308 A	2FD	105	0,35	1,7	122	0,9
45	75	20	15,5	20	1	1	0,3	16	32009 XA	3CC	57	0,4	1,5	82,2	0,8
	75	24	19	24	1	1	0,3	16,3	33009	2CE	69	0,29	2	99	1,1
	80	26	20,5	26	1,5	1,5	0,3	19	33109	3CE	84	0,38	1,57	115	0,86
	85	19	16	20,75	1,5	1,5	0,6	18	30209 A	3DB	60,1	0,4	1,5	67,1	0,8
	85	23	19	24,75	1,5	1,5	0,6	20	32209 A	3DC	76,5	0,4	1,5	91,6	0,8
	85	32	25	32	1,5	1,5	0,6	22	33209	3DE	107	0,39	1,56	146	0,86
	100	25	22	27,25	2	1,5	0,6	21	30309 A	2FB	106	0,35	1,7	118	0,9
	100	25	18	27,25	2	1,5	0,6	31	31309 A	7FB	88,9	0,83	0,7	97,1	0,4
	100	36	30	38,25	2	1,5	0,6	25	32309 A	2FD	133	0,35	1,7	159	0,9
	50	80	20	15,5	20	1	1	0,3	18	32010 XA	3CC	58,5	0,43	1,4	88,5
80		24	19	24	1	1	0,3	17	33010	2CE	75	0,32	1,9	113	1,04
85		26	20	26	1,5	1,5	0,3	20	33110	3CE	86	0,41	1,46	122	0,8
90		20	17	21,75	1,5	1,5	0,6	19	30210 A	3DB	69,7	0,43	1,4	81,3	0,8
90		23	19	24,75	1,5	1,5	0,6	21	32210 A	3DC	79,1	0,43	1,4	95,8	0,8
90		32	24,5	32	1,5	1,5		23	33210	3DE	115	0,41	1,45	163	0,8
110		27	23	29,25	2,5	2	0,6	23	30310 A	2FB	120	0,35	1,7	133	0,9
110		27	19	29,25	2,5	2	0,6	34	31310 A	7FB	102	0,83	0,7	112	0,4
110		40	33	42,25	2,5	2	0,6	27	32310 A	2FD	160	0,35	1,7	194	0,9
55		90	23	17,5	23	1,5	1,5	0,6	20	32011 XA	3CC	77	0,4	1,5	117
	90	27	21	27	1,5	1,5	0,6	19	33011	2CE	94	0,31	1,92	142	1,06
	95	30	23	30	1,5	1,5	0,6	22	33111	3CE	113	0,37	1,6	163	0,88
	100	21	18	22,75	2	1,5	0,6	20	30211 A	3DB	83	0,4	1,5	95,2	0,8
	100	25	21	26,75	2	1,5	0,6	22	32211 A	3DC	96,2	0,4	1,5	115	0,8
	100	35	27	35	2	1,5	0,6	26	33211	3DE	138	0,4	1,5	194	0,83
	120	29	25	31,5	2,5	2	0,6	24	30311 A	2FB	146	0,35	1,7	166	0,9
	120	29	21	31,5	2,5	2	0,6	37	31311 A	7FB	118	0,83	0,7	133	0,4
	120	43	35	45,5	2,5	2	0,6	29	32311 A	2FD	191	0,35	1,7	235	0,9
	60	95	23	17,5	23	1,5	1,5	0,6	21	32012 XA	4CC	78,5	0,43	1,4	119
95		27	21	27	1,5	1,5	0,6	20	33012	2CE	95	0,33	1,83	148	1,01
100		30	23	30	1,5	1,5	0,6	23	33112	3CE	116	0,4	1,51	171	0,83
110		22	19	23,75	2	1,5	0,6	22	30212 A	3EB	91,6	0,4	1,5	105	0,8
110		28	24	29,75	2	1,5	0,6	24	32212 A	3EC	122	0,4	1,5	152	0,8
110		38	29	38	2	1,5	0,6	28	33212	3EE	169	0,4	1,48	237	0,82
130		31	26	33,5	3	2,5	1	26	30312 A	2FB	164	0,35	1,7	187	0,9
130		31	22	33,5	3	2,5	1	39	31312 A	7FB	140	0,83	0,7	158	0,4
130		46	37	48,5	3	2,5	1	31	32312 A	2FD	229	0,35	1,7	288	0,9

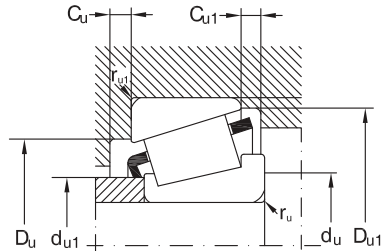

Speed limit		Mass	Mounting dimensions								
grease	oil		du1 max.	du min.	Du		Du1 min.	Cu min.	Cu1 min.	ru max.	ru1 max.
					min.	max.					
min ⁻¹		Kg									
4800	6300	0,74	47	47	67	73	76	5	7	1,5	1,5
4500	6000	0,7	48	49	77	81	82	3	5	2	1,5
4000	5300	0,685	52	49	71	81	86	4	8	2	1,5
4000	5300	0,993	51	49	73	81	82	4	8	2	1,5
4800	6300	0,33	50	51	67	69	72	4	4,5	1	1
4800	6300	0,41	51	54	67	69	71	4	5	1	1
4800	6300	0,597	52	52	69	73	77	4	5,5	1,5	1,5
4500	6000	0,47	51	52	74	78	80	3	4,5	1,5	1,5
4500	6000	0,56	54	52	73	78	80	3	5,5	1,5	1,5
4500	6000	0,89	52	52	72	78	81	5	7	1,5	1,5
4000	5300	0,92	53	54	86	91	92	3	5	2	1,5
3400	4500	0,915	59	54	79	91	95	4	9	2	1,5
3600	4800	1,25	56	54	82	91	93	4	8	2	1,5
4500	6000	0,36	56	56	72	74	77	4	4,5	1	1
4500	6000	0,47	56	56	72	74	76	4	5	1	1
4300	5600	0,6	56	57	74	78	82	4	6	1,5	1,5
4300	5600	0,53	58	57	79	83	85	3	4,5	1,5	1,5
4300	5600	0,6	58	57	78	83	85	3	5,5	1,5	1,5
4300	5600	0,97	57	57	77	83	87	5	7,5	1,5	1,5
3600	4800	1,19	65	60	95	100	102	4	6	2,5	2
3200	4300	1,16	62	60	87	100	104	4	10	2,5	2
3200	4300	1,83	62	60	90	100	102	5	9	2,5	2
4000	5300	0,54	63	62	81	83	86	4	5,5	1,5	1,5
4000	5300	0,67	63	62	81	83	86	5	6	1,5	1,5
3800	5000	0,89	62	62	83	88	91	5	7	1,5	1,5
3800	5000	0,69	64	64	88	91	94	4	4,5	1,5	1,5
3800	5000	0,82	63	64	87	91	95	4	5,5	1,5	1,5
3800	5000	1,17	62	64	85	91	96	6	8	2	1,5
3200	4300	1,53	71	65	104	110	111	4	6,5	2	2
2800	3800	1,49	68	65	94	110	113	4	10,5	2	2
3000	4000	2,21	68	65	99	110	111	5	10,5	2	2
3800	5000	0,58	67	67	85	88	91	4	5,5	1,5	1,5
3800	5000	0,71	67	67	85	88	90	5	6	1,5	1,5
3400	4500	1,01	67	67	88	93	96	5	7	1,5	1,5
3400	4500	0,86	70	69	96	101	103	4	4,5	2	1,5
3400	4500	1,1	69	69	95	101	104	4	5,5	2	1,5
3400	4500	1,55	69	69	93	101	105	6	9	2	1,5
3000	4000	1,9	77	72	112	118	120	5	7,5	3	2,5
2600	3600	1,83	73	72	103	118	123	5	11,5	3	2,5
2600	3600	2,8	74	72	107	118	120	6	11,5	3	2,5

Tapered roller bearings, single row

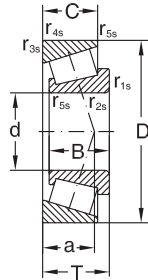

Dimensions									Designation	ISO series	Basic radial load. Factors				
d	D	B	C	T	r _{1s,2s} min.	r _{3s,4s} min.	r ₅ min.	a			dyn. C _r	e	Y	stat C _{0r}	Y ₀
mm											kN	-	-	kN	-
65	100	23	17,5	23	1,5	1,5	0,6	22	32013 XA	4CC	80,6	0,46	1,3	123	0,7
	100	27	21	27	1,5	1,5	0,6	21	33013	2CE	100	0,35	1,72	161	0,95
	110	34	26,5	34	1,5	1,5	0,6	26	33113	3DE	149	0,39	1,55	225	0,85
	120	23	20	24,75	2	1,5	0,6	23	30213 A	3EB	111	0,4	1,5	129	0,8
	120	31	27	32,75	2	1,5	0,6	27	32213 A	3EC	149	0,4	1,5	189	0,8
	120	41	32	41	2	1,5	0,6	30	33213	3EE	203	0,39	1,54	285	0,85
	140	33	28	36	3	2,5	1	28	30313 A	2GB	191	0,35	1,7	220	0,9
	140	33	23	36	3	2,5	1	42	31313 A	7GB	164	0,83	0,7	189	0,4
70	140	48	39	51	3	2,5	1	33	32313 A	2GO	256	0,35	1,7	322	0,9
	110	25	19	25	1,5	1,5	0,6	23	32014 XA	4CC	95,6	0,43	1,4	143	0,8
	110	31	25,5	31	1,5	1,5	0,6	22	33014	2CE	136	0,28	2,11	223	1,16
	120	37	29	37	2	1,5	0,6	28	33114	3DE	174	0,38	1,58	260	0,87
	125	24	21	26,25	2	1,5	0,6	25	30214 A	3EB	119	0,43	1,4	143	0,8
	125	31	27	33,25	2	1,5	0,6	28	32214 A	3EC	157	0,43	1,4	204	0,8
	125	41	32	41	2	1,5	0,6	31	33214	3EE	210	0,41	1,47	300	0,81
	150	35	30	38	3	2,5	1	29	30314 A	2GB	224	0,35	1,7	264	0,9
75	150	35	25	38	3	2,5	1	45	31314 A	7GB	185	0,83	0,7	215	0,4
	150	51	42	54	3	2,5	1	36	32314 A	2GD	297	0,35	1,7	381	0,9
	115	25	19	25	1,5	1,5	0,6	25	32015 XA	4CC	97,3	0,46	1,3	149	0,7
	115	31	25,5	31	1,5	1,5	0,6	23	33015	2CE	139	0,3	2,01	232	1,11
	125	37	29	37	2	1,5	0,6	30	33115	3DE	178	0,4	1,51	275	0,83
	130	25	22	27,25	2	1,5	0,6	27	30215 A	4DB	134	0,43	1,4	166	0,8
	130	31	27	33,25	2	1,5	0,6	29	32215 A	4DC	157	0,43	1,4	205	0,8
	130	41	31	41	2	1,5	0,6	32	33215	3EE	206	0,43	1,4	310	0,77
80	160	37	31	40	3	2,5	1	31	30315 A	2GB	246	0,35	1,7	289	0,9
	160	37	26	40	3	2,5	1	48	31315 A	7GB	213	0,83	0,7	251	0,4
	160	55	45	58	3	2,5	1	38	32315 A	2GD	350	0,35	1,7	460	0,9
	125	29	22	29	1,5	1,5	0,6	27	32016 XA	3CC	130	0,43	1,4	198	0,8
	125	36	29,5	36	1,5	1,5	0,6	26	33016	2CE	175	0,28	2,16	290	1,19
	130	37	29	37	2	1,5	0,6	31	33116	3DE	188	0,42	1,44	300	0,79
	140	26	22	28,25	2,5	2	0,6	28	30216 A	3EB	145	0,43	1,4	177	0,8
	140	33	28	35,25	2,5	2	0,6	30	32216 A	3EC	180	0,43	1,4	232	0,8
85	140	46	35	46	2,5	2	0,6	35	33216	3EE	250	0,43	1,41	380	0,78
	170	39	33	42,5	3	2,5	1	33	30316 A	2GB	277	0,35	1,7	329	0,9
	170	39	27	42,5	3	2,5	1	52	31316 A	7GB	222	0,83	0,7	275	0,4
	170	58	48	61,5	3	2,5	1	41	32316 A	2GD	383	0,35	1,7	503	0,9
	130	29	22	29	1,5	1,5	0,6	28	32017 XA	4CC	136	0,44	1,4	213	0,8
	130	36	29,5	36	1,5	1,5	0,6	26	33017	2CE	184	0,29	2,06	315	1,13
	140	41	32	41	2,5	2	0,6	33	33117	3DE	221	0,41	1,48	350	0,81
	150	28	24	30,5	2,5	2	0,6	30	30217 A	3EB	167	0,43	1,4	206	0,8

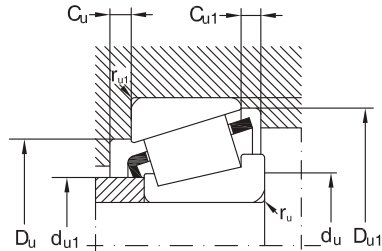

Speed limit		Mass Kg	Mounting dimensions								
grease	oil		du1 max.	du min.	Du		Du1 min.	Cu min.	Cu1 min.	ru max.	ru1 max.
					min.	max.					
min ⁻¹											
3400	4500	0,62	72	72	90	93	97	4	5,5	1,5	1,5
3400	4500	0,76	72	72	89	93	96	5	6	1,5	1,5
3000	4000	1,31	73	72	96	103	106	6	7,5	1,5	1,5
3000	4000	1,1	77	74	106	111	113	4	4,5	2	1,5
3000	4000	1,48	76	74	104	111	115	4	5,5	2	1,5
3000	4000	2,02	74	74	102	111	115	6	9	2	1,5
2600	3600	2,3	83	77	122	128	130	5	8	3	2,5
2200	3200	2,25	79	77	111	111	128	5	13	3	2,5
2400	3400	3,49	80	77	117	128	130	6	12	3	2,5
3200	4300	0,83	78	77	98	103	105	5	6	1,5	1,5
3200	4300	1,14	78	77	99	103	105	5	5,5	1,5	1,5
3000	4000	1,71	79	79	104	111	115	6	8	2	1,5
3000	4000	1,22	81	79	110	116	118	4	5	2	1,5
2800	3800	1,56	80	79	108	116	119	4	6	2	1,5
2800	3800	2,06	79	79	107	116	120	7	9	2	1,5
2400	3400	3	89	82	130	138	140	5	8	3	2,5
2000	3000	2,82	84	82	118	138	141	5	13	3	2,5
2200	3200	4,1	86	82	125	138	140	6	12	3	2,5
3000	4000	0,88	83	82	103	108	110	5	6	1,5	1,5
3000	4000	1,16	83	82	104	108	110	6	5,5	1,5	1,5
2800	3800	1,79	84	84	109	116	120	6	8	2	1,5
2800	3800	1,33	86	84	115	121	124	4	5	2	1,5
2600	3600	2,62	85	84	115	121	124	4	6	2	1,5
2600	3600	2,47	83	84	111	121	125	7	10	2	1,5
2600	3600	3,4	95	87	139	148	149	5	9	3	2,5
1900	2800	3,5	91	87	127	148	151	6	14	3	2,5
2000	3000	5	91	87	133	148	149	7	13	3	2,5
2600	3600	1,24	89	87	112	117	120	6	7	1,5	1,5
2600	3600	1,67	90	87	112	117	119	6	6,5	1,5	1,5
2400	3400	1,9	89	89	114	121	126	6	8	2	1,5
2400	3400	1,59	91	90	124	130	132	4	6	2,5	2
2400	3400	2	90	90	122	130	134	5	7	2,5	2
2400	3400	2,93	89	90	119	130	135	7	11	2,5	2
2000	3000	4	102	92	148	158	159	5	9,5	3	2,5
1900	2800	4,07	97	92	134	158	159	6	15,5	3	2,5
1900	2800	5,9	98	92	142	158	159	7	13,5	3	2,5
2400	3400	1,3	94	92	117	122	125	6	7	1,5	1,5
2400	3400	1,75	94	92	118	122	125	6	6,5	1,5	1,5
2200	3200	2,38	95	95	122	130	135	7	9	2,5	2
2200	3200	2	97	95	132	140	141	5	6,5	2,5	2

Tapered roller bearings, single row

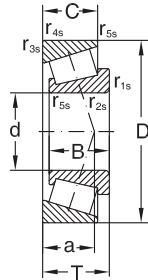

Dimensions									Designation	ISO series	Basic radial load. Factors				
d	D	B	C	T	r _{1s,2s} min.	r _{3s,4s} min.	r ₅ min.	a			dyn. C _r	e	Y	stat C _{0r}	Y ₀
mm											kN	-	-	kN	-
85	150	36	30	38,5	2,5	2	0,6	33	32217 A	3EC	213	0,43	1,4	283	0,8
	150	49	37	49	2,5	2	0,6	37	33217	3EE	295	0,42	1,43	435	0,79
	180	41	34	44,5	4	3	1	35	30317 A	2GB	298	0,35	1,7	354	0,9
	180	41	28	44,5	4	3	1	55	31317 A	7GB	245	0,83	0,7	298	0,4
180	60	49	63,5	4	3	1	42	32317 A	2GD	400	0,35	1,7	555	0,9	
90	140	32	24	32	2	1,5	0,6	30	32018 XA	3CC	159	0,43	1,4	246	0,8
	140	39	32,5	39	2	1,5	0,6	28	33018	2CE	216	0,27	2,23	365	1,23
	150	45	35	45	2,5	2	0,6	36	33118	3DE	265	0,4	1,51	420	0,83
	160	30	26	32,5	2,5	2	0,6	31	30218 A	3FB	190	0,43	1,4	238	0,8
	160	40	34	42,5	2,5	2	0,6	36	32218 A	3FC	251	0,43	1,4	340	0,8
	190	43	36	46,5	4	3	1	36	30318 A	2GB	328	0,35	1,7	394	0,9
	190	43	30	46,5	4	3	1	57	31318 A	7GB	270	0,83	0,7	330	0,4
	190	64	53	67,5	4	3	1	44	32318 A	2GD	461	0,35	1,7	612	0,9
95	145	32	24	32	2	1,5	0,6	31	32019 XA	4CC	163	0,44	1,4	257	0,8
	145	39	32,5	39	2	1,5	0,6	29	33019	2CE	221	0,28	2,16	380	1,19
	170	32	27	34,5	3	2,5	1	33	30219 A	2FB	210	0,43	1,4	264	0,8
	170	43	37	45,5	3	2,5	1	39	32219 A	3FC	281	0,43	1,4	390	0,8
	200	45	38	49,5	4	3	1	39	30319 A	2GB	350	0,35	1,7	449	0,9
	200	45	32	49,5	4	3	1	60	31319 A	7GB	300	0,83	0,7	365	0,4
	200	67	55	71,5	4	3	1	47	32319 A	2GD	500	0,35	1,7	670	0,9
100	150	32	24	32	2	1,5	0,6	32	32020 XA	4CC	171	0,46	1,3	277	0,7
	150	39	32,5	39	2	1,5	0,6	29	33020	2CE	225	0,29	2,09	395	1,15
	180	34	29	37	3	2,5	1	35	30220 A	3FB	238	0,43	1,4	303	0,8
	180	46	39	49	3	2,5	1	41	32220 A	3FC	320	0,43	1,4	444	0,8
	180	63	48	63	3	2,5	1	46	33220	3FE	430	0,4	1,48	660	0,82
	215	47	39	51,5	4	2	1	40	30320 A	2GB	404	0,35	1,7	492	0,9
105	160	35	26	35	2,5	2	0,6	34	32021 XA	4DC	204	0,44	1,4	334	0,8
	160	43	34	43	2,5	2	0,6	31	33021	2DE	265	0,28	2,12	450	1,17
	190	36	30	39	3	2,5	1	37	30221 A	3FB	270	0,43	1,4	350	0,8
	190	50	43	53	3	2,5	1	44	32221 A	3FC	358	0,43	1,4	510	0,8
	225	77	63	81,5	4	3	1	53	33221 A	2GD	405	0,35	1,7	815	0,9
	170	38	29	38	2,5	2	0,6	36	32022 XA	4DC	235	0,43	1,4	382	0,8
110	170	47	37	47	2,5	2	0,6	33	33022	2DE	295	0,29	2,09	520	1,15
	180	56	43	56	2,5	2	0,6	44	33122	3EE	370	0,42	1,43	630	0,79
	200	38	32	41	3	2,5	1	39	30222 A	3FB	304	0,43	1,4	396	0,8
	200	53	46	56	3	2,5	1	46	32222 A	3FC	406	0,43	1,4	580	0,8
	240	50	42	54,5	4	3	1	43	30322 A	2GB	479	0,35	1,7	588	0,9
	240	80	65	84,5	4	3	1	55	32322 A	2GD	699	0,35	1,7	956	0,9
120	180	38	29	38	2,5	2	0,6	39	32024 XA	4DC	238	0,46	1,3	397	0,7

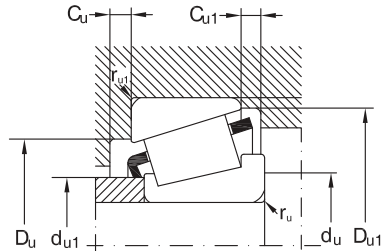

Speed limit		Mass	Mounting dimensions								
grease	oil		du1 max.	du min.	Du		Du1 min.	Cu min.	Cu1 min.	ru max.	ru1 max.
					min.	max.					
min ⁻¹		Kg									
2200	3200	2,5	96	95	130	140	142	5	8,5	2,5	2
2200	3200	3,58	95	95	128	140	144	7	12	2,5	2
1900	2800	4,7	107	99	156	166	167	6	10,5	4	3
1800	2600	5,08	103	99	143	166	169	6	16,5	4	3
1800	2600	6,85	103	99	150	166	167	8	14,5	4	3
2200	3200	1,7	100	99	125	131	134	6	8	2	1,5
2200	3200	2,48	100	99	127	131	135	7	6,5	2	1,5
2200	3000	3,19	100	100	130	140	144	7	10	2,5	2
2200	3000	2,49	103	100	140	150	150	5	6,5	2,5	2
2000	3000	3,3	102	100	138	150	152	5	8,5	2,5	2
1700	2400	5,5	113	104	165	176	176	6	10,5	4	3
1700	2400	5,92	109	104	151	176	179	6	16,5	4	3
1700	2400	8,21	108	104	157	176	177	8	14,5	4	3
2200	3200	1,8	105	104	130	136	140	6	8	2	1,5
2200	3200	2,33	104	104	131	136	139	7	6,5	2	1,5
1900	2800	2,96	110	107	149	158	159	5	7,5	3	2,5
1900	2800	4	108	107	145	158	161	5	8,5	3	2,5
1800	2600	6,7	118	109	172	186	184	6	11,5	4	3
1700	2400	6,95	114	109	157	186	187	6	17,5	4	3
1700	2400	11	115	109	166	186	186	8	16,5	4	3
2000	3000	1,85	109	109	134	141	144	6	8	2	1,5
2000	3000	2,42	108	109	135	141	143	7	6,5	2	1,5
1900	2800	3,54	116	112	157	168	168	5	8	3	2,5
1800	2600	4,76	114	112	154	168	171	5	10	3	2,5
1800	2600	6,77	112	112	151	168	172	10	15	3	2,5
1700	2400	7,9	127	114	184	201	197	6	12,5	4	3
1600	2200	14	123	114	177	201	200	8	17,5	4	3
1900	2800	2,42	116	115	143	150	154	6	9	2,5	2
1900	2800	3,34	116	115	145	150	153	7	9	2,5	2
1800	2600	4,26	122	117	165	178	177	6	9	3	2,5
1800	2600	5,9	120	117	161	178	180	5	10	3	2,5
1500	2000	14,5	128	119	185	211	209	9	18,5	4	3
1800	2600	3,06	122	120	152	160	163	7	9	2,5	2
1800	2600	4,16	123	120	152	160	161	7	10	2,5	2
1700	2400	5,54	121	120	155	170	174	9	13	2,5	2
1700	2400	5	129	122	174	188	187	6	9	3	2,5
1700	2400	6,9	126	122	170	188	190	6	10	3	2,5
1600	2200	12,5	141	124	206	226	220	8	12,5	4	3
1400	1900	16,4	137	124	198	226	222	9	19,5	4	3
1700	2400	3,25	131	130	161	170	173	7	9	2,5	2

Tapered roller bearings, single row

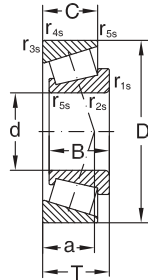

Dimensions									Designation	ISO series	Basic radial load. Factors				
d	D	B	C	T	r _{1s,2s} min.	r _{3s,4s} min.	r ₅ min.	a			dyn. C _r	e	Y	stat C _{0r}	Y ₀
mm											kN	-	-	kN	-
120	180	48	38	48	2,5	2	0,6	36	33024	2DE	310	0,31	1,97	560	1,08
	215	40	34	43,5	3	2,5	1	43	30224 A	4FB	340	0,43	1,4	459	0,8
	215	58	50	61,5	3	2,5	1	51	32224 A	4FD	446	0,43	1,4	653	0,8
	260	55	46	59,5	4	3	1	47	30324 A	2GB	568	0,35	1,7	712	0,9
	260	86	69	90,5	4	3	1	60	32324 A	2GD	799	0,35	1,7	1104	0,9
130	200	45	34	45	2,5	2	0,6	42	32026 XA	4EC	315	0,43	1,4	526	0,8
	230	40	34	43,75	4	3	1	45	30226 A	4FB	367	0,43	1,4	485	0,8
	230	64	54	67,75	4	3	1	56	32226 A	4FD	551	0,43	1,4	836	0,8
	280	58	49	63,75	5	4	1,5	51	30326 A	2GB	640	0,35	1,7	820	0,9
	280	66	44	72	5	4	1,5	87	31326 A	7GB	597	0,83	0,7	761	0,4
280	93	78	98,75	5	4	1,5	66	32326 A	-	947	0,35	1,7	1333	0,9	
140	210	45	34	45	2,5	2	0,6	46	32028 XA	4DC	312	0,46	1,3	529	0,7
	250	42	36	45,75	4	3	1	47	30228 A	4FB	396	0,43	1,4	527	0,8
	250	68	58	71,75	4	3	1	60	32228 A	4FD	602	0,43	1,4	907	0,8
	300	70	47	77	5	4	1,5	90	31328 XA	7GB	714	0,83	0,7	935	0,4
150	225	48	36	48	3	2,5	1	49	32030 XA	4EC	355	0,46	1,3	620	0,7
	225	59	46	59	3	2,5	1	48	33030	2EE	465	0,36	1,65	880	0,9
	270	45	38	49	4	3	1	50	30230 A	4GB	457	0,43	1,4	618	0,8
	270	73	60	77	4	3	1	64	32230 A	4GD	705	0,43	1,4	1080	0,8
160	240	51	38	51	3	2,5	1	52	32032 XA	4EC	402	0,46	1,3	696	0,7
	290	48	40	52	4	3	1	54	30232 A	4GB	520	0,43	1,4	710	0,8
	290	80	67	84	4	3	1	70	32232 A	4GD	840	0,43	1,4	1400	0,8
170	230	38	30	38	2,5	2	0,6	42	32934 A	3DC	280	0,37	1,6	572	0,9
	260	57	43	57	3	2,5	1	56	32034 XA	4EC	480	0,44	1,4	865	0,8
	310	52	43	57	5	4	1,5	58	30234 A	4GB	610	0,43	1,4	844	0,8
	310	86	71	91	5	4	1,5	75	32234 A	4GD	889	0,43	1,4	1377	0,8
180	250	45	34	45	2,5	2	0,6	53	32936 A	4DC	350	0,48	1,3	727	0,7
	280	64	48	64	3	2,5	1	59	32036 XA	3FD	599	0,43	1,4	1037	0,8
	320	52	43	57	5	4	1,5	61	30236 A	4GB	584	0,46	1,3	825	0,7
	320	86	71	91	5	4	1,5	78	32236 A	4GD	974	0,46	1,3	1571	0,7
190	260	45	34	45	2,5	2	0,6	55	32938 A	4DC	358	0,48	1,3	772	0,7
	290	64	48	64	3	2,5	1	62	32038 XA	4FD	609	0,44	1,4	1077	0,8
	340	92	75	97	5	4	1,5	81	32238 A	4GD	1080	0,43	1,4	1860	8
200	280	51	39	51	3	2,5	1	53	32940 A	3EC	474	0,4	1,5	950	0,8
	310	70	53	70	3	2,5	1	66	32040 XA	4FD	716	0,43	1,4	1356	0,8
	310	70	53	70	3	2,5	1	66	T32040 X	4FD	716	0,43	1,4	1356	0,8
	310	70	53	70	3	2,5	1	66	T32040 XP5	4FD	716	0,43	1,4	1356	0,8
	360	98	82	104	5	4	1,5	83	32240 A	3GD	1220	0,4	1,5	2020	0,8
220	300	51	39	51	3	2,5	1	58	32944 M	3EC	407	0,43	1,4	827	0,8
	340	76	57	76	4	3	1	72	32044 XA	4FD	850	0,43	1,4	1537	0,8

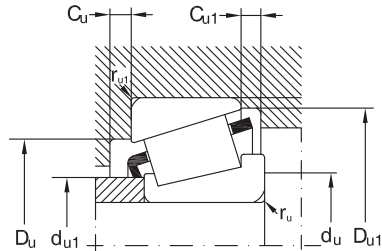

Speed limit		Mass	Mounting dimensions								
grease	oil		du1 max.	du min.	Du		Du1 min.	Cu min.	Cu1 min.	ru max.	ru1 max.
					min.	max.					
min ⁻¹		Kg									
1700	2400	4,55	132	130	160	170	171	6	10	2,5	2
1600	2200	6,01	140	132	187	203	201	6	9,5	3	2,5
1600	2200	8,59	136	132	181	203	204	7	11,5	3	2,5
1500	2000	13,6	152	134	221	246	237	10	13,5	4	3
1300	1800	24,5	148	134	213	246	239	9	21,5	4	3
1600	2200	4,93	144	140	178	190	192	8	11	2,5	2
1500	2000	7,6	152	144	203	216	217	7	9,5	4	3
1500	2000	10,7	146	144	193	216	219	7	13,5	4	3
1300	1800	19,5	164	148	239	262	255	8	14,5	5	4
1200	1700	18,6	157	148	218	262	261	9	28	5	4
1100	1600	27,6	160	148	230	262	260	10	20,5	5	4
1600	2200	5,23	153	150	187	200	202	8	11	2,5	2
1400	1900	8,5	163	154	219	236	234	9	9,5	4	3
1400	1900	13,9	159	154	210	236	238	8	13,5	4	3
1200	1700	23,9	169	158	235	282	280	9	30	5	4
1500	2000	6,35	164	162	200	213	216	8	12	3	2,5
1500	2000	8,23	164	162	200	213	217	8	13	3	2,5
1300	1800	10,7	175	164	234	256	250	9	11	4	3
1200	1700	17,9	171	164	226	256	254	8	17	4	3
1300	1800	7,75	175	172	213	228	231	8	13	3	2,5
1100	1600	13,6	189	174	252	276	269	9	12	4	3
1100	1600	25,5	183	174	242	276	274	10	17	4	3
1400	1900	4,5	183	180	213	220	222	7	8	2,5	2
1200	1700	10,5	187	182	230	248	249	10	14	3	2,5
1000	1500	19	203	188	269	292	288	8	14	5	4
1000	1500	29,3	196	188	259	292	294	10	20	5	4
1200	1700	6,65	193	190	225	240	241	8	11	2,5	2
1100	1600	14,5	199	192	247	268	267	10	16	3	2,5
1000	1500	20	211	198	278	302	297	9	14	5	4
950	1400	27,4	204	198	267	302	303	10	20	5	4
1100	1600	7	204	200	235	249	251	8	11	2,5	2
1000	1500	15	209	202	257	278	279	10	16	3	2,5
900	1300	39,5	216	207	286	322	323	10	22	5	4
1000	1500	9,5	216	212	257	268	271	9	12	3	2,5
950	1400	19,5	221	212	273	298	297	11	17	3	2,5
950	1400	19,5	221	212	273	298	297	11	17	3	2,5
950	1400	19,5	221	212	273	298	297	11	17	3	2,5
900	1300	33	226	217	302	342	340	11	22	5	4
950	1400	11,2	234	232	275	288	290	9	12	3	2,5
900	1300	25,5	243	234	300	326	326	12	19	4	3

Tapered roller bearings with flanged outer ring

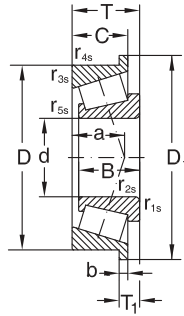

Dimensions												Designation
d	D	B	C	T	$r_{1s,2s}$ min.	$r_{3s,4s}$ min.	r_s min.	T_1	D_1	C_1	a	
mm												
20	47	14	12	15,25	1	1	0,3	6,25	51	3	11	30204 AR
25	52	15	13	16,25	1	1	0,3	6,75	57	3,5	12	30205 AR
30	62	16	14	17,25	1	1	0,3	6,75	67	3,5	14	30206 AR
	62	20	17	21,25	1	1	0,3	8,25	67	4	15	32206 AR
	72	19	16	20,75	1,5	1,5	0,6	8,75	77	4	15	30306 AR
	72	27	23	28,75	1,5	1,5	0,6	11,75	77	6	18	32306 AR
35	72	17	15	18,25	1,5	1,5	0,6	7,25	77	4	15	30207 AR
	72	23	19	24,75	1,5	1,5	0,6	10,25	77	4,5	17	32207 AR
	80	21	18	22,75	2	1,5	0,6	8,25	85	4,5	16	30307 AR
	80	31	25	32,75	2	1,5	0,6	13,75	85	6	20	32307 AR
40	80	18	16	19,75	1,5	1,5	0,6	7,75	85	4	16	30208 AR
	80	23	19	24,75	1,5	1,5	0,6	10,25	85	4,5	19	32208 AR
	90	23	20	25,25	2	1,5	0,6	9,75	95	4,5	19	30308 AR
	90	33	27	35,25	2	1,5	0,6	14,25	95	6	23	32308 AR
45	85	19	16	20,75	1,5	1,5	0,6	8,75	90	4	18	30209 AR
	85	23	19	24,75	1,5	1,5	0,6	10,25	90	4,5	20	32209 AR
	100	25	22	27,25	2	1,5	0,6	10,25	106	5	21	30309 AR
	100	36	30	38,25	2	1,5	0,6	15,25	106	7	25	32309 AR
50	90	20	17	21,75	1,5	1,5	0,6	8,75	95	4	19	30210 AR
	90	23	19	24,75	1,5	1,5	0,6	10,25	95	4,5	21	32210 AR
	110	27	23	29,25	2,5	2	0,6	11,25	116	5	23	30310 AR
	110	40	33	42,25	2,5	2	0,6	17,25	116	8	28	32310 AR
55	100	21	18	22,75	2	1,5	0,6	9,25	106	4,5	20	30211 AR
	100	25	21	26,75	2	1,5	0,6	10,75	106	5	22	32211 AR
	120	43	35	45,5	2,5	2	0,6	18,5	127	8	29	32311 AR
60	110	22	19	23,75	2	1,5	0,6	9,25	116	4,5	22	30212 AR
	110	28	24	29,75	2	1,5	0,6	10,75	116	5	24	32212 AR
	130	46	37	48,5	3	2,5	1	19,5	137	8	31	32312 AR
65	120	23	20	24,75	2	1,5	0,6	9,25	127	4,5	23	30213 AR
	120	31	27	32,75	2	1,5	0,6	11,75	127	6	26	32213 AR
70	125	24	21	26,25	2	1,5	0,6	10,25	132	5	25	30214 AR
	125	31	27	33,25	2	1,5	0,6	12,25	132	6	28	32214 AR

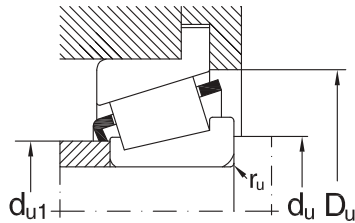

ISO series	Basic radial load. Factors					Speed limit		Mass	Mounting dimensions			
	dyn. C_r	e	γ	stat C_{0r}	Y_0	grease	oil		d_{u1} max.	d_u min.	D_u min.	r_u max.
	kN	-	-	kN	-	min ⁻¹			Kg			
2DB	26	0,35	1,7	29	0,9	8000	11000	0,127	27	26	43	1
3CC	29,5	0,37	1,6	36	0,9	7500	10000	0,161	31	31	48	1
3DB	38	0,37	1,6	48	0,9	6300	8500	0,233	37	36	57	1
3DC	47,5	0,37	1,6	65	0,9	6300	8500	0,29	37	36	59	1
2FB	53	0,31	1,9	65	1,1	5600	7500	0,398	39	37	66	1,5
2FD	72,3	0,31	1,9	97	1,1	5600	7000	0,577	40	37	66	1,5
3DB	49,4	0,37	1,6	58	0,9	5300	7000	0,338	44	42	67	1,5
3DC	61,6	0,37	1,6	80	0,9	5300	7000	0,422	43	42	67	1,5
2FB	68,2	0,31	1,9	83	1,1	5000	6700	0,543	45	44	74	2
2FE	88,2	0,31	1,9	120	1,1	4800	6300	0,76	44	44	74	2
3DB	58,5	0,37	1,6	70	0,9	4800	6300	0,44	49	47	74	1,5
3DC	71	0,37	1,6	95	0,9	4800	6300	0,533	48	47	75	1,5
2FB	81	0,35	1,7	105	0,9	4500	6000	0,725	52	49	82	2
2FD	110	0,35	1,7	156	0,9	4000	5300	1,027	50	49	82	2
3DB	63	0,4	1,5	83	0,8	4500	6000	0,491	54	52	80	1,5
3DC	75	0,4	1,5	103	0,8	4500	6000	0,584	53	52	80	1,5
2FB	101	0,35	1,7	130	0,9	4000	5300	0,958	59	54	92	2
2FD	132	0,35	1,7	188	0,9	3600	4800	1,3	56	54	93	2
3DB	70,5	0,43	1,4	95	0,8	4300	5600	0,552	58	57	85	1,5
3DC	76,5	0,43	1,4	106	0,8	4300	5600	0,625	58	57	85	1,5
2FB	120	0,35	1,7	156	0,9	3600	4800	1,23	65	60	102	2,5
2FD	165	0,35	1,7	239	0,9	3200	4300	1,89	62	60	102	2,5
3DB	84,5	0,4	1,5	112	0,8	3800	5000	0,724	64	64	94	1,5
3DC	99	0,4	1,5	138	0,8	3800	5000	0,858	63	64	95	1,5
2FD	187	0,35	1,7	276	0,9	3000	4000	2,29	68	65	111	2
2EB	91,5	0,4	1,5	122	0,8	3400	4500	0,897	70	69	103	2
2EC	120	0,4	1,5	170	0,8	3400	4500	1,14	69	69	104	2
2FD	216	0,35	1,7	318	0,9	2600	3600	1,92	74	72	120	3
3EB	110	0,4	1,5	147	0,8	3000	4000	1,14	77	74	113	2
3EC	142	0,4	1,5	206	0,8	3000	4000	1,54	76	74	115	2
3EB	120	0,43	1,4	163	0,8	3000	4000	1,27	81	79	118	2
3EC	150	0,43	1,4	220	0,8	2800	3800	1,62	80	79	119	2

Tapered roller bearings, single row inch dimensions

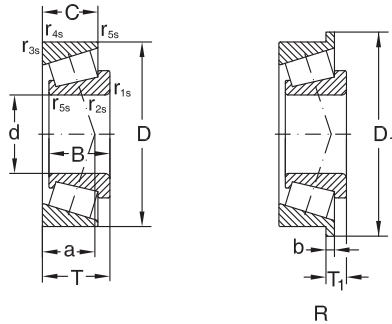

Dimensions									Designation
d	D	B	C	T / T ₁	r _{1s,2s} min.	r _{3s,4s} min.	D ₁	a	
mm									
11,112	34,988	10,988	8,730	10,998	1,3	1,3		9	A4044/A4138
12,700	34,988	10,988	8,730	10,998	1,3	1,3		9	A4050/A4138
14,989	34,988	10,988	8,730	10,998	0,8	1,3		9	A4059/A4138
15,875	42,862	16,670	13,495	16,670	1,5	1,5			17580/17520
17,462	39,878	14,605	10,668	13,843	1,3	1,3		9	LM11749/LM11710
19,050	39,992	11,153	9,525	12,014	1	1,3			A6075/A6157
	45,237	16,637	12,065	15,494	1,3	1,3		10	LM11949/LM11910
	49,225	19,050	14,288	18,034	1,3	1,3		11	09067/09195
21,430	50,005	18,288	13,970	17,526	1,3	1,3		11	M12649/M12610
21,987	45,237	16,637	12,065	15,494	1,3	1,3		10	LM12749/LM12710
	45,974	16,637	12,065	15,494	1,3	1,3		10	LM12749/LM12711
22,225	56,896	19,837	15,875	19,368	1,3	1,3			1755/1729
23,812	56,896	19,837	15,875	19,368	0,8	1,3		12,5	1779/1729
25,000	51,994	14,260	12,700	15,011	1,5	1,3		12	07097/07204
	51,994	14,260	12,700	15,011	1,5	1,3			07100S/07204
25,400	50,005	14,260	9,525	13,495	1,5	1			07097/07196
	50,005	14,260	9,525	13,495	1	1		11	07100/07196
	50,292	14,732	10,668	14,224	1,3	1,3		11	L44643/L44610
	57,150	19,431	14,732	19,431	1,5	1,5		16,3	M84548/M84510
	61,912	20,638	14,288	19,050	0,8	2			15101/15243
	62,000	20,638	14,288	19,050	3,5	1,3		13,3	15100/15245
	62,000	20,638	14,288	19,050	0,8	1,3		13,3	15101/15245
	26,988	50,292	14,732	10,668	14,224	3,5	1,3		11
28,575	68,262	22,225	17,462	22,225	0,8	1,5		17,1	02474/02420
29,000	50,292	14,732	10,668	14,224	3,5	1,3		11	L45449/L45410
30,162	64,292	21,433	16,670	21,433	1,5	1,5		18,2	M86649/M86610
30,226	69,012	19,583	15,875	19,845	0,8	1,3		15,9	14116/14276
	59,131	16,764	11,811	15,875	*	1,3		13	LM67048/LM67010
31,750	62,000	19,050	14,288	18,161	3,5	1,3		13	15123/15245
	68,262	22,225	17,462	22,225	3,5	1,5		17,1	02475/02420
	69,012	19,583	15,875	19,845	3,5	1,3		15,9	14125A/14276
	69,012	19,583	15,875	19,845	0,8	1,3			14124/14276
	68,262	22,225	17,462	22,225	0,8	1,5		19,2	M88048/M88010
33,338	76,200	28,575	23,020	29,370	0,8	3,3		23,8	HM89443/HM89410
	65,088	18,288	13,970	18,034	*	1,3		14	LM48548/LM48510
34,925	69,012	26,721	15,875	26,982	0,8	1,3		15,9	14136A/14276
	72,233	25,400	19,842	25,400	2,3	2,3		21	HM88649/HM88610
	76,200	28,575	23,020	29,370	3,5	3,3		23	HM89446/HM89410

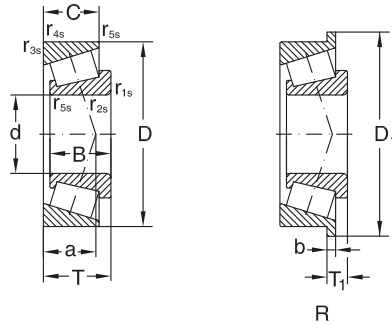

R

Basic radial load. Factors					Speed limit		Mass
dyn. C_r	e	Y	stat C_{0r}	Y_0	grease	oil	
kN	-	-	kN	-	min ⁻¹		Kg
12	0,45	1,3	11,85	0,7	11000	15000	0,055
12	0,45	1,3	11,85	0,7	10000	15000	0,058
12	0,45	1,3	11,85	0,7	10000	14000	0,063
29,1	0,33	1,81	29,2	1	9800	13000	0,11
19,8	0,29	2,1	21,1	1,2	8500	12000	0,081
12,4	0,53	1,14	12,3	0,63	10000	13000	0,07
25,5	0,3	2	25,104	1,1	7500	11000	0,123
31,1	0,27	2,3	33,1	1,2	7000	10000	0,16
34,1	0,28	2,2	38	1,2	7000	10000	0,16
25,2	0,31	2	27,7	1,1	7500	10000	0,122
25,2	0,31	2	27,7	1,1	7000	10000	0,123
42	0,31	1,9	45,3	1,07	7200	9600	0,24
42	0,31	1,9	45,3	1,07	7200	9600	0,24
23,7	0,4	1,5	27,5	0,8	6300	9000	0,14
27	0,4	1,5	29,6	0,8	6300	9500	0,14
27	0,4	1,5	29,6	0,8	6300	9000	0,11
23,7	0,4	1,5	27,5	0,8	6300	9500	0,115
23,4	0,37	1,6	25,913	0,9	6300	9000	0,125
44,9	0,55	1,1	52,9	0,6	6900	9200	0,23
46,8	0,35	1,71	53,9	0,9	6100	8200	0,29
46,8	0,35	1,71	53,9	0,94	6100	8200	0,29
46,8	0,35	1,7	53,9	0,9	6100	8200	0,29
23,4	0,37	1,6	25,913	0,9	6300	9000	0,115
59,1	0,42	1,44	70,2	0,79	5800	7700	0,4
24,1	0,37	1,6	32,2	0,9	6300	9000	0,115
55,7	0,55	1,1	71,7	0,6	6100	8100	0,33
50,6	0,38	1,57	61,7	0,86	5600	7400	0,36
31,1	0,41	1,5	35,912	0,8	5300	7500	0,18
43,9	0,35	1,7	49,708	0,9	5300	7500	0,228
59,1	0,42	1,44	70,2	0,79	5800	7700	0,37
50,6	0,38	1,57	61,7	0,86	5600	7400	0,34
50,6	0,38	1,57	61,7	0,86	5600	7400	0,35
59,6	0,55	1,1	77,4	0,6	5700	7500	0,37
86,2	0,55	1,1	119	0,6	5100	6800	0,66
42,9	0,38	1,6	50,696	0,9	4800	7000	0,248
50,6	0,38	1,57	61,7	0,86	5600	7400	0,36
66,5	0,55	1,1	86,61	0,6	4500	6700	0,487
72,5	0,55	1,1	97,9	0,6	4500	6300	0,57

Tapered roller bearings, single row inch dimensions

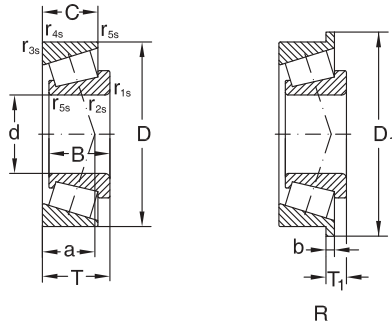

Dimensions									Designation
d	D	B	C	T / T ₁	r _{1s,2s} min.	r _{3s,4s} min.	D ₁	a	
mm									
34,987	59,131	16,764	11,938	15,875	*	1,3		13	L68149/L68110
	59,974	16,764	11,938	15,875	*	1,3		13	L68149/L68111
36,512	76,200	28,575	23,020	29,370	3,5	3,3		23,8	HM89449/HM89410
	76,200	28,575	23,020	29,370	3,5	0,8			HM89449/HM89411
38,000	63,000	17,000	13,500	17,000	*	1,3		14	JL69349/JL69310
38,100	65,088	18,288	13,970	18,034	2,3	1,3		13	LM29749/LM29710
	69,012	19,050	15,083	19,050	3,5	2,3		15,9	13685/13621
	79,375	29,771	23,812	29,370	3,5	3,3		20	3490/3420
39,688	73,025	22,098	21,336	25,654	0,8	2,3		18	M201047/M201011
40,987	67,975	18,000	13,500	17,500	3,5	1,5		13,8	LM300849/LM300811
41,275	73,431	19,812	16,604	21,430	3,5	0,8		18,1	LM501349/LM501314
	73,431	19,812	14,732	19,559	3,5	0,8		16	LM501349/LM501310
	76,200	17,384	14,880	18,009	1,5	1,5		17,1	11162/11300
44,450	73,025	18,258	15,083	18,258	1,5	1,5		14	L102849/L102810
	82,931	25,400	19,050	23,812	3,5	0,8		18	25580/25520
	82,931	25,400	19,050	23,812	0,5	0,8		17,4	25581/25520
	88,900	29,370	23,020	30,162	3,5	3,3		25,5	HM803149/HM803110
	95,250	28,575	22,225	27,783	0,8	0,8		20	33885/33822
	95,250	28,575	22,225	30,958	3,5	0,8		31,4	HM903249/HM903210
	104,775	36,512	28,575	36,512	3,5	3,3		28,8	HM807040/HM807010
45,242	107,950	29,317	22,225	27,783	3,5	0,8		20	460/453 A
	73,431	19,812	15,748	19,558	3,5	0,8		15	LM102949/LM102910
45,618	77,788	19,842	15,080	19,842	3,5	0,8		17,3	LM603049/LM603011
	82,931	25,400	19,050	23,812	3,5	0,8		18	25590/25520
	82,931	25,400	22,225	26,988	3,5	2,3		19	25590/25523
46,037	85,000	25,608	20,638	25,400	0,8	1,3		19	2984 A/2924
47,625	93,264	30,302	23,812	30,162	3,5	3,3		21	3779/3730
49,212	104,775	36,512	28,575	36,512	3,5	3,3		28,8	HM807044/HM807010
	103,188	44,475	36,512	43,658	3,5	3,3		27,4	5395/5335
50,000	82,000	21,500	17,000	21,500	3	0,5		16,3	JLM104948/JLM104910
	90,000	28,000	23,000	28,000	3	2,5		20,6	JM205149/JM205110
	90,000	22,225	15,875	8,887	2		94,661	16	365/362 R
50,800	82,550	22,225	16,510	21,590	3,5	1,3		16	LM104949/LM104911
	92,075	25,400	19,845	24,608	3,5	0,8		20	28580/28521
	95,250	28,575	22,225	27,783	3,5	0,8		20	33889/33822
	97,630	24,608	19,446	9,124	3,5		101,549	21	28678/28622 R
	104,775	36,512	28,575	36,512	3,5	3,3		29,1	HM807046/HM807010
	111,125	26,909	20,638	30,162	3,5	3,3		37	55200 C/55437

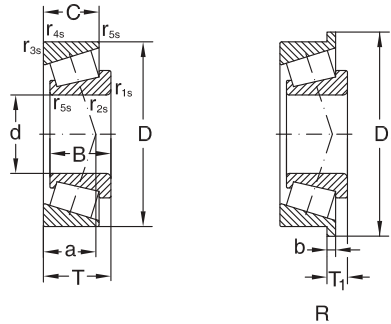

R

Basic radial load. Factors					Speed limit		Mass
dyn. C_r	e	Y	stat C_{or}	Y_0	grease	oil	
kN	-	-	kN	-	min ⁻¹		Kg
30,1	0,42	1,4	38,841	0,8	5300	7500	0,17
30,1	0,42	1,4	38,841	0,8	5300	7500	0,18
86,2	0,55	1,1	119	0,6	5100	6800	0,62
86,2	0,55	1,1	119	0,6	5100	6800	0,63
32,9	0,42	1,4	43,8	0,8	4800	7000	0,221
38,4	0,33	1,8	48,72	1	4800	6700	0,227
52,5	0,4	1,49	67,9	0,82	5300	7100	0,28
79,3	0,36	1,6	103	0,9	4300	6000	0,55
57,5	0,33	1,8	72	1	4300	6300	0,46
46,1	0,35	1,72	63,5	0,95	5300	7000	0,23
58,4	0,4	1,5	74,2	0,83	5000	6600	0,34
48,6	0,4	1,5	64,3	0,8	4300	6000	0,32
44,5	0,49	1,23	55,1	0,68	4900	6500	0,33
47	0,32	1,9	68,9	1	4300	6000	0,3
75,7	0,33	1,8	95,1	1	3800	5600	0,554
83,8	0,33	1,8	111	1	3800	5600	0,56
105	0,55	1,1	144	0,6	4300	5800	0,84
120	0,33	1,8	161	1	3600	5000	0,98
107	0,74	0,81	132	0,45	3700	4900	1
159	0,49	1,23	223	0,68	3600	4800	1,62
96,8	0,33	1,8	127	1	3600	5000	0,97
97,8	0,34	1,8	134	1	3000	4500	0,31
59,6	0,43	1,41	77,9	0,77	4600	6200	0,36
48,5	0,31	2	66,4	1,1	4000	6000	0,3
70	0,33	1,8	95,2	1	3800	5300	0,55
70	0,33	1,8	95,2	1	3800	5300	0,58
68,3	0,35	1,7	97	1	3800	5300	0,6
159	0,49	1,23	223	0,68	3600	4800	1,52
182	0,3	2,02	246	1,97	3800	5100	1,72
75,2	0,31	1,97	104	1,08	4300	5700	0,41
115	0,33	1	154	1,82	4100	5400	0,74
98	0,34	1,8	128	1	3400	5000	0,905
74,3	0,32	1,9	87,26	1	3400	5000	0,554
65,2	0,31	2	86,2	1,1	3600	5300	0,411
71	0,38	1,6	103	0,9	3400	4800	0,69
102	0,33	1,8	135	1	3400	4800	0,86
159	0,49	1,23	223	0,68	3600	4800	1,49
118	0,88	0,68	161	0,37	3200	4200	1,34

Tapered roller bearings, single row inch dimensions

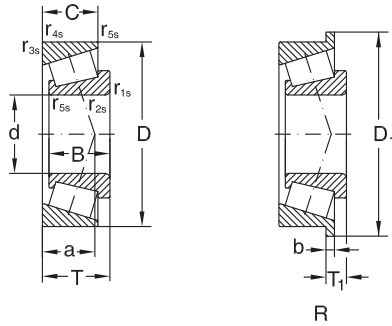

Dimensions									Designation
d	D	B	C	T / T ₁	r _{1s,2s} min.	r _{3s,4s} min.	D ₁	a	
mm									
53,975	104,775	36,512	28,575	36,512	3,5	3,3		28,8	HM807049/HM807010
	123,825	32,791	25,400	36,512	3,5	3,3			72212 C/72487
	123,825	32,791	25,400	17,462	3,5		130,073	37	72212/72487 R
55,562	123,825	32,791	25,400	36,512	3,5	3,3			72218 C/72487
	104,775	30,958	23,812	30,162	2,3	3,3			45290/45220
57,150	104,775	30,958	23,812	30,162	6,4	3,3			45291/45220
	104,775	29,317	24,605	30,162	2,3	3,3		23	462A/453 X
	107,950	29,317	22,225	27,783	3,5	0,8		20,7	469/453A
	110,000	29,317	27,000	27,795	3,5	2		24	462/454
	112,712	30,162	23,812	30,162	8	3,3		23	39581/39520
	123,825	36,678	30,162	38,100	3,5	3,3		28,4	555S/552A
60,325	122,238	38,354	29,718	38,100	8	3,3		27,2	HM212044/HM212011
	127,000	44,450	34,925	44,450	3,5	3,3		34,9	65237/65500
	127,000	36,512	26,988	36,512	3,5	3,3		32	HM813841/HM813810
63,485	94,976	15,499	11,999	17,000	1	1		28	L910349/L910310
	92,075	12,700	9,525	13,495	1,5	1,5		16	LL510749/LL510710
63,500	94,458	19,050	15,083	19,050	1,5	1,5			L610549/L610510
	112,712	30,162	23,812	30,162	3,5	3,3		23	39585/39520
	112,712	30,048	23,812	30,162	3,5	0,8		25	3982/3928
	112,712	30,048	23,812	30,162	3,5	3,3		25	3982/3920
	112,712	30,048	23,812	11,112	3,5		117,373	25	3982/3920 R
	120,000	29,007	23,444	29,002	3,5	3,3		26	483/472 A
	122,238	38,354	29,718	38,100	7	3,3		27,2	HM212047/HM212011
	122,238	38,430	29,770	38,305	3,5	2		27	X3962/X3963
66,675	110,000	25,400	19,050	25,400	3,5	1,3		24	29590/29521
	122,238	38,354	29,718	38,100	3,5	3,3		27	HM212049/HM212011
	112,712	30,048	23,812	30,162	3,5	3,3		25	3984/3920
70,000	110,000	25,000	20,500	26,000	1	2,5		20,5	JLM813049/JLM813010
	120,000	32,545	26,195	32,545	3,5	3,3		25,8	47490/47420
71,438	136,525	46,038	36,512	46,038	3,5	3,3		38	H715345/H715311
	127,000	36,170	28,575	36,512	3,5	3,3		28	567 A/563
	127,000	36,170	28,575	36,512	3,5	3,3		28	567/563
73,025	139,992	36,098	28,575	36,512	3,5	3,3		30,8	576/572
	146,050	41,275	31,750	41,275	3,5	3,3		34	657/653
	133,350	33,338	26,195	33,338	3,5	3,3			47679/47620
76,200	139,992	36,098	28,575	36,512	3,5	3,3		31	575/572
	149,225	54,229	44,450	53,975	9,7	3,3		38,8	6461 A/6420
	150,089	46,672	36,512	44,450	3,5	3,3		32,3	748S/742

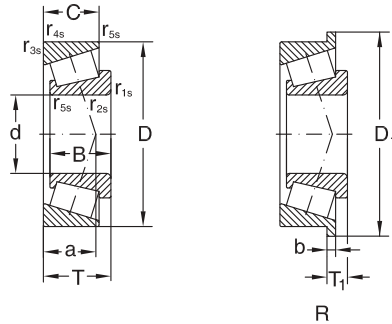

R

Basic radial load. Factors					Speed limit		Mass
dyn. C_r	e	Y	stat C_{0r}	Y_0	grease	oil	
kN	-	-	kN	-	min ⁻¹		Kg
159	0,49	1,23	223	0,68	3600	4800	1,41
167	0,74	0,81	208	0,45	2900	3900	2,12
143	0,74	0,8	162	0,4	2800	4000	2,1
167	0,74	0,81	208	0,45	2900	3900	2,08
142	0,33	1,8	189	1	3000	4300	1,08
142	0,33	1,8	189	1	3000	4300	1,06
97,8	0,34	1,8	134	1	3000	4500	1,1
126	0,34	1,79	166	1	3500	4700	1,09
109	0,34	1,8	139	1	3000	4300	1,22
130	0,34	1,8	196	1	2800	4000	1,03
177	0,35	1,73	248	1	3000	4100	2,14
209	0,34	1,78	279	0,98	3100	4100	1,99
225	0,49	1,23	297	0,68	3100	4200	2,66
161	0,5	1,2	226	0,7	2600	3800	2,16
42,3	0,78	0,8	56,8	0,4	3000	4500	0,4
31,2	0,4	1,5	46	0,8	3200	4500	0,25
62	0,42	1,41	108	0,78	3600	4800	0,45
130	0,34	1,8	196	1	2800	4000	1,22
116	0,4	1,5	174	0,8	2800	4000	1,24
116	0,4	1,5	174	0,8	2800	4000	1,24
116	0,4	1,5	174	0,8	2800	4000	1,26
133	0,38	1,6	167	0,9	2600	3800	1,44
209	0,34	1,78	279	0,98	3100	4100	1,91
189	0,34	1,8	248	1	2600	3800	2,03
92	0,44	1,4	138	0,7	2800	4000	0,9
189	0,34	1,8	248	1	2600	3800	1,92
113	0,4	1,5	172	0,8	2800	4000	1,2
106	0,49	1,23	168	0,68	3200	4200	0,88
166	0,36	1,67	249	0,9	3000	4000	1,41
219	0,48	1,2	296	0,7	2400	3400	2,91
161	0,36	1,7	226	0,9	2400	3600	1,64
161	0,36	1,7	226	0,9	2400	3400	2,68
191	0,4	1,49	292	0,82	2600	3400	2,47
213	0,41	1,5	307	0,8	2200	3200	3,31
167	0,4	1,48	262	0,7	2600	3500	1,9
184	0,4	1,5	239	0,8	2200	3200	2,35
321	0,36	1,66	463	0,91	2500	3400	4,15
294	0,33	1,84	417	1,01	2400	3200	3,62

Tapered roller bearings, single row inch dimensions

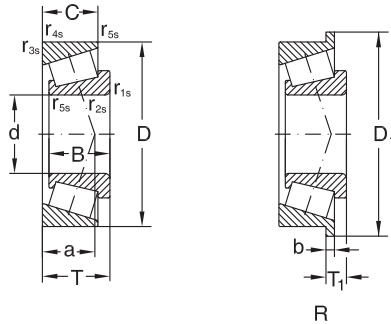

R

Dimensions									Designation
d	D	B	C	T / T ₁	r _{1s,2s} min.	r _{3s,4s} min.	D ₁	a	
mm									
76,200	161,925	55,100	42,862	53,975	3,5	3,3		40	6576/6535
77,788	120,000	23,012	16,000	23,000	3,5	2,3		24	34306/34472 X
80,962	150,089	46,672	36,512	44,450	5	3,3		32,3	740/742
82,550	133,350	33,338	26,195	33,338	3,5	3,3		29,5	47686/47620
	139,992	36,098	28,575	36,512	3,5	3,3		31	580/572
	146,050	41,275	31,750	41,275	3,5	3,3		34	663/653
	152,400	41,275	31,750	41,275	3,5	3,3		33,7	663/652
	161,925	48,260	38,100	47,625	3,5	3,3		35	757/752
85,025	150,089	46,672	36,512	44,450	3,5	3,3		32,3	749/742
	133,350	29,769	25,400	33,338	3,3	3,3		31	497/492 W
85,725	146,050	41,275	31,750	41,275	6,4	3,3		34	665 A/653
	152,400	36,322	30,162	39,688	3,5	3,3			596/592 A
	152,400	36,322	30,162	39,688	3,5	3,3		36,8	593/592 A
88,900	152,400	39,688	30,162	39,688	6,4	3,3		34	HM518445/HM518410
	161,925	48,260	38,100	47,625	3,5	3,3		34,9	759/752
	190,500	57,531	46,038	57,150	8	3,3		41	HH221434/HH221410
	146,975	40,000	32,500	40,000	7	3,5		31	HM218248/HM218210
92,075	152,400	36,322	30,162	39,688	6,4	3,3		35	598 A/592 A
	171,450	48,260	38,100	47,625	3,5	3,3		37	77362/77675
95,250	148,430	28,971	21,433	28,575	3	3		33	42375/42584
	152,400	36,322	30,162	15,875	3,5		158,648	35	594/592 R
	152,400	36,322	30,162	39,688	3,5	3,3		37	594/592 A
	168,275	41,275	30,162	41,275	3,5	3,3		38,5	683/672
96,838	149,225	28,971	24,608	12,700	3,5		154,681	34	42381/42587 R
100,012	157,162	36,116	26,195	36,512	3,5	3,3		36	52393/52618
101,600	180,975	48,006	38,100	17,462	3,5		188,798	40	780/772 R
	212,725	66,675	53,975	66,675	7	3,3		48	HH224335/HH224310
114,300	177,800	41,275	30,162	41,275	3,5	3,3		43	64450/64700
	190,500	49,212	34,925	47,625	3,6	3,3			71450/71750
117,475	180,975	31,750	25,400	34,925	3,5	3,3		39,6	68462/68712
120,650	174,625	36,512	27,783	35,720	3,5	1,5			M224749/M224710
	206,375	47,625	34,925	47,625	3,5	3,5			795/792
127,000	215,900	47,625	34,925	47,625	3,5	3,3		49,9	74500/74850
130,000	234,950	63,500	49,212	63,500	6	3,3			95512/95925
133,350	215,900	47,625	34,925	20,638	3,5		223,733		74525/74850 R
136,525	215,900	47,625	34,925	20,638	3,5		223,733		74537/74850 R
139,700	215,900	47,625	34,925	47,625	3,5	3,3			74550/74850
	215,900	47,625	34,925	20,638	3,5		223,733		74550/74850 R

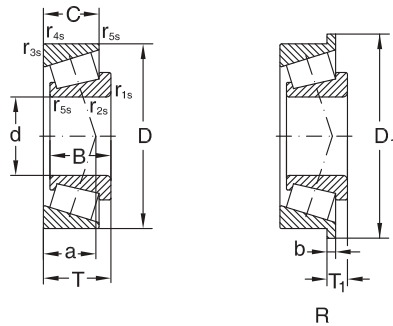

R

Basic radial load. Factors					Speed limit		Mass
dyn. C_r	e	Y	stat C_{0r}	Y_0	grease	oil	
kN	-	-	kN	-	min ⁻¹		Kg
327	0,4	1,5	448	0,8	2000	3000	5,37
84,91	0,45	1,3	117	0,7	2400	3600	0,836
294	0,33	1,84	417	1,01	2400	3200	3,39
167	0,4	1,48	262	0,7	2400	3400	1,69
168	0,4	1,5	247	0,8	2200	3200	2,13
201	0,41	1,5	286	0,8	2200	3000	3,73
229	0,41	1,47	335	0,81	2500	3300	3,12
272	0,34	1,8	358	1	2000	2800	4,7
294	0,33	1,84	417	1,01	2400	3300	3,21
135	0,45	1,3	203	0,7	2200	3200	1,34
213	0,41	1,5	307	0,8	2200	3000	2,6
200	0,44	1,36	319	0,75	2300	3100	2,86
200	0,44	1,36	319	0,75	2300	3100	2,73
235	0,4	1,5	338	0,8	2000	3000	2,8
303	0,34	1,76	441	0,97	2300	3100	4,06
395	0,34	1,8	526	1	1800	2600	8,85
220	0,33	1,8	386	1	2000	3000	2,59
174	0,44	1,4	268	0,7	2000	2800	2,59
305	0,37	1,6	416	0,9	1900	2600	4,79
136	0,49	1,2	416	0,7	2000	2800	1,72
204	0,44	1,4	313	0,7	2000	2800	2,64
200	0,44	1,36	319	0,75	2000	2800	2,47
245	0,47	1,28	386	0,7	2100	2800	3,68
136	0,49	1,2	210	0,7	2000	2800	1,74
142	0,47	1,3	195	0,7	1900	2800	2,47
321	0,39	1,6	462	0,9	1700	2400	5,5
557	0,33	1,8	783	1	1600	2200	11,1
254	0,52	1,15	419	0,6	2600	3800	3,45
337	0,42	1,44	543	0,79	1800	2500	5,14
181	0,47	1,28	271	0,7	2100	2800	2,74
220	0,33	1,8	375	1	1700	2400	2,7
308	0,49	1,2	523	0,7	1400	2000	6,97
507	0,36	1,6	784	0,9	1300	1900	11,3
313	0,49	1,2	528	0,7	1400	2000	6,78
313	0,49	1,2	528	0,7	1400	2000	6,53
310	0,49	1,2	531	0,7	1400	2000	6,08
310	0,49	1,2	531	0,7	1400	2000	6,17

Tapered roller bearings, single row inch dimensions

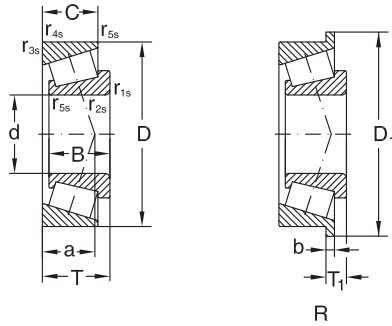

Dimensions									Designation
d	D	B	C	T / T ₁	r _{1s,2s} min.	r _{3s,4s} min.	D ₁	a	
mm									
158,750	225,425	39,688	33,338	41,275	3,5	3,3			46780/46720
	225,425	39,688	33,338	13,495	3,5		230,881		46780/46720 R
180,000	250,000	45,000	37,000	47,000	3	2,5			JM736149/JM36110
196,850	254,000	27,783	21,433	28,575	1,5	1,5			L540049/L540010
203,200	261,142	27,783	21,433	28,575	1,5	1,5			LL641149/LL641110
209,550	282,575	46,038	36,512	46,038	3,5	3,3			67989/67920
	317,500	63,500	46,038	63,500	4,3	3,3			93825/93125
234,950	327,025	52,388	36,512	52,388	6,4	3,3			8575/8520
241,300	327,025	52,388	36,512	25,400	6,4		336,448		8578/8520 R

* Special mounting chamfer.

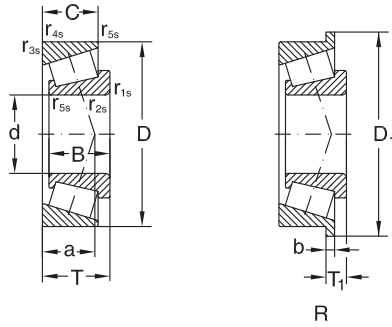

Basic radial load. Factors					Speed limit		Mass
dyn. C_r	e	γ	stat C_{0r}	Y_0	grease	oil	
kN	-	-	kN	-	min ⁻¹		Kg
305	0,38	1,6	541	0,9	1300	1800	5,35
305	0,38	1,6	541	0,9	1300	1800	5,4
334	0,48	1,3	703	0,7	1100	1600	7,85
170	0,39	1,5	334	0,9	1100	1600	3,32
174	0,41	1,5	353	0,8	1100	1500	3,56
331	0,51	1,2	661	0,6	1000	1400	8,84
651	0,52	1,2	1098	0,6	950	1300	18,5
468	0,41	1,5	934	0,8	850	1200	12,3
468	0,41	1,5	934	0,8	850	1200	11,9



Spherical roller bearings

Spherical roller bearings operate in arduous conditions. The spherical rollers can be symmetrical or unsymmetrical and are self-aligning in the outer ring sphered raceway. Thus, the possible coaxiality deviations of the supporting bearings as well as shaft bending can be compensated.

Spherical roller bearings are manufactured in the following constructive versions, depending on the bearing size and series.

MB design

These bearings have a central fixed rib and machined cages guided on the inner ring rib.

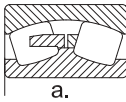

MA design

These bearings have a central fixed rib and machined cages guided on the outer ring rib.

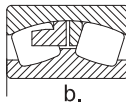

C design

These bearings have a central guide rib floating on the inner ring, symmetrical rollers with larger dimensions so that the load carrying capacity increases. Special pressed sheet cage. Bearings of this design are of small and medium sizes.

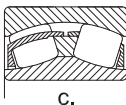

CA design

These bearings have side shoulders and an one-piece machined brass cage. They also have symmetrical rollers with larger dimensions so that the load carrying capacity increases. This design is available for medium and large-sized bearings

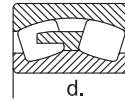

Other constructive versions are shown below:

Cylindrical bore, lubrication groove and holes in the outer ring



Tapered bore, lubrication groove and holes in the outer ring (taper 1:12, 1:30)



With adapter sleeves

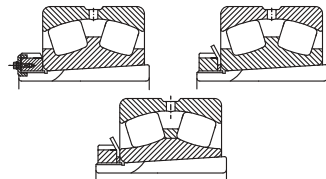

With withdrawal sleeves.



Suffixes

- C** - modified inner design, increased basic load, symmetrical rollers, pressed sheet cage.
- CA** - modified inner design, increased basic load, one-piece machined brass cage
- F2, F3** - constructive modifications
- K** - tapered bore bearings, taper 1:12
- K30** - tapered bore bearings, taper 1:30
- MA** - machined brass cage guided on the outer ring
- MB** - machined brass cage guided on the inner ring
- P** - two-piece outer ring
- W33** - lubrication groove and holes in the outer ring

Tolerances

Spherical roller bearings with both cylindrical and tapered bore, are manufactured in normal tolerance class (see chapter Bearing tolerance, page 25).

Radial Clearance

Spherical roller bearings are generally manufactured with normal radial clearance. At request, they can be manufactured with clearances larger than normal (C3, C4 etc.) or smaller than normal (C2).

The limit values of the radial clearance measured on unloaded bearings are in accordance with SR ISO 5753 and are given in tables 1 and 2.

Dimensions

The main dimensions of spherical roller bearings are in accordance with ISO 15 and national standard SR 3918 respectively.

The dimensions of the adapter sleeves are in accordance with national standard SR ISO 2982-1.

The dimensions of the safety washers are in accordance with national standard SR ISO 2982-2.

Radial clearance of spherical roller bearings with cylindrical bore

Table 1

Bore diameter d		Radial clearance									
		C2		Normal		C3		C4		C5	
over	up to	min	max	min	max	min	max	min	max	min	max
14	18	10	20	20	35	35	45	45	60	60	75
18	24	10	20	20	35	35	45	45	60	60	75
24	30	15	25	25	40	40	55	55	75	75	95
30	40	15	30	30	45	45	60	60	80	80	100
40	50	20	35	35	55	55	75	75	100	100	125
50	65	20	40	40	65	65	90	90	120	120	150
65	80	30	50	50	80	80	110	110	145	145	180
80	100	35	60	60	100	100	135	135	180	180	225
100	120	40	75	75	120	120	160	160	210	210	260
120	140	50	95	95	145	145	190	190	240	240	300
140	160	60	110	110	170	170	220	220	280	280	350
160	180	65	120	120	180	180	240	240	310	310	390
180	200	70	130	130	200	200	260	260	340	340	430
200	225	80	140	140	220	220	290	290	380	380	470
225	250	90	150	150	240	240	320	320	420	420	520
250	280	100	170	170	260	260	350	350	460	460	570
280	315	110	190	190	280	280	370	370	500	500	630
315	355	120	200	200	310	310	410	410	550	550	690
355	400	130	220	220	340	340	450	450	600	600	750
400	450	140	240	240	370	370	500	500	660	660	820
450	500	140	260	260	410	410	550	550	720	720	900
500	560	150	280	280	440	440	600	600	780	780	1000
560	630	170	310	310	480	480	650	650	850	850	1100
630	710	190	350	350	530	530	700	700	920	920	1190
710	800	210	390	390	580	580	770	770	1010	1010	1300
800	900	230	430	430	650	650	860	860	1120	1120	1440
900	1000	260	480	480	710	710	930	930	1220	1220	1570

Radial clearance of spherical roller bearings with tapered bore

Table 2

Bore diameter d		Radial clearance									
		C2		Normal		C3		C4		C5	
over	up to	min	max	min	max	min	max	min	max	min	max
18	24	15	25	75	35	35	45	45	60	60	75
24	30	20	30	30	40	40	55	55	75	75	95
30	40	25	35	35	50	50	65	65	85	85	105
40	50	30	45	45	60	60	80	80	100	100	130
50	65	40	55	55	75	75	95	95	120	120	160
65	80	50	70	70	95	95	120	120	150	150	200
80	100	55	80	80	110	110	140	140	180	180	230
100	120	65	100	100	135	135	170	170	220	220	280
120	140	80	120	120	160	160	200	200	260	260	330
140	160	90	130	130	180	180	230	230	300	300	380
160	180	100	140	140	200	200	260	260	340	340	430
180	200	110	160	160	220	220	290	290	370	370	470
200	225	120	180	180	250	250	320	320	410	410	520
225	250	140	200	200	270	270	350	350	450	450	570
250	280	150	220	220	300	300	390	390	490	490	620
280	315	170	240	240	330	330	430	430	540	540	680
315	355	190	270	270	360	360	470	470	590	590	740
355	400	210	300	300	400	400	520	520	650	650	820
400	450	230	330	330	440	440	570	570	720	720	910
450	500	260	370	370	490	490	630	630	790	790	1000
500	560	290	410	410	540	540	680	680	870	870	1100
560	630	320	460	460	600	600	760	760	980	980	1230
630	710	350	510	510	670	670	850	850	1090	1090	1360
710	800	390	570	570	750	750	960	960	1220	1220	1500
800	900	440	640	640	840	840	1070	1070	1370	1370	1690
900	1000	490	710	710	930	930	1190	1190	1520	1520	1860

The dimensions of the bearings nuts are in accordance with national standard SR ISO 2982-2.

The dimensions of the withdrawal sleeves are in accordance with national standard SR ISO 2982-1 and pages 416-437.

Misalignment

Spherical roller bearings allow angular misalignment between the outer ring and Inner ring without any influence on the bearing rating life. Under normal loads and operating conditions and when the Inner ring rotates, the values of the permissible misalignment depending on the bearing series are given in table 3.

Cages

Small and medium size spherical roller bearing are fitted with pressed sheet or machined brass cages (Y). Bearings of normal design are fitted with

machined brass or steel cages guided on the rollers (M), inner ring (MB) or outer ring raceway (MA).

Glass fibre reinforced polyamide 6.6 cages are successfully used for small and medium size bearings if the operating temperature doesn't exceed +120°C.



Large-size bearings are fitted with machined brass cages, CA design.

Designs and some technical data are given in table 4.

Table 3	
Bearing series	Permissible angular misalignment [degrees]
213	1
222	1,5
223	2
230	1,5
231	1,5
232	2,5
239	1,5
240	2
241	2,5

Cage design and some technical data

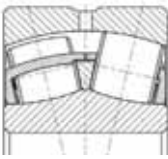
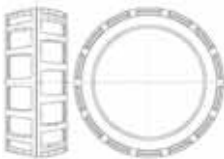
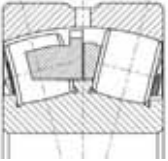
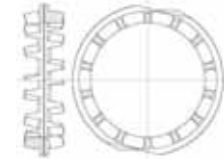
Table 4

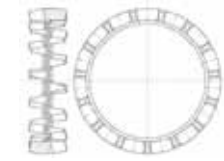
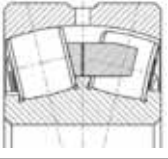
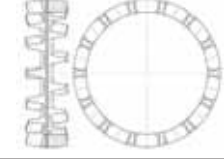
Cage	Design		Application	Max. value D _n	
	bearing	cage		oil	grease
C design - Floating guiding middle collar on inner ring - Special steel sheet cage - Oversize symmetrical spherical rollers to provide for increased loading capacity - Small and middle size bearings are produced in this version			- General application design - Moderate speeds - Bearings with d<200mm	300 x 10 ³	225 x 10 ³
MA design - Machined solid brass cage guided on outer ring - Middle standing collar on inner ring - Side flanges on inner ring			- General application - Moderate and high speeds - Bearings with d>200 mm	400 x 10 ³	300 x 10 ³
CA design - One-piece solid brass cage - Side flanges on inner ring - Oversize symmetrical spherical rollers to provide with increased loading capacity - Middle and large size bearings are produced in this version			- General application - Bearings with d>200 mm	350 x 10 ³	265 x 10 ³
MB design - Middle standing collar on inner ring - Machined solid brass cage guided on collar - Side flanges on inner ring - All bearings sizes can be produced in this version			- General application - Bearings with d>40mm	350 x 10 ³	265 x 10 ³

Lubrication grooves and holes

Spherical roller bearings are provided with a lubrication groove and holes in the outer ring, excepting those of series 213. Designation suffix W33 is used to identify this feature on bearings. The dimensions of the groove, bore diameter and their number depending on the dimension series are given in table 5.

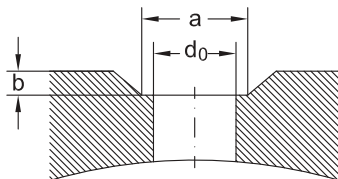

Axial load for bearings mounted on adapter sleeves

If the spherical roller bearings are mounted on a smooth shaft using an adapter sleeve, without side support, the axial load carrying capacity depends on the friction between shaft and sleeve.

Considering that the mounting is correctly done, the permissible axial load can be accurately enough determined using the following equation

$$F_{a \max} = 3 * B * d, \text{ KN}$$

where:

$F_{a \max}$ - maximum permissible axial load, KN;

B - bearing width, mm;

d - bearing bore diameter, mm.

Dimensions of lubrication grooves and holes

Table 5

Series 23900				Series 23000				Series 24000			
Outer diameter range	Dimensions			Outer diameter range	Dimensions			Outer diameter range	Dimensions		
	d0	a	b		d0	a	b		d0	a	b
mm				mm				mm			
250 ... 380	4,5	7,2	1,5	170 ... 225	4,5	7,2	1,5	... 200	4,5	7,2	1,5
380 ... 440	4,5	7,2	2	225 ... 280	6	9,6	2	200 ... 240	6	9,6	2
440 ... 520	6	9,6	3	280 ... 310	7,5	12,1	2,5	240 ... 280	7,5	12,1	2,5
520 ... 560	7,5	12,1	3	310 ... 480	9	14,5	3	280 ... 520	9	14,5	3
560 ... 670	9	14,5	3	480 ... 980	12	19,7	3	520 ... 600	9	14,5	3
670 ... 1000	12	19,7	3,5					600 ... 980	12	19,7	3

Series 23100				Series 24100				Series 22200			
Outer diameter range	Dimensions			Outer diameter range	Dimensions			Outer diameter range	Dimensions		
	d0	a	b		d0	a	b		d0	a	b
mm				mm				mm			
250 ... 380	4,5	7,2	1,5	170 ... 225	4,5	7,2	1,5	... 200	4,5	7,2	1,5
380 ... 440	4,5	7,2	2	225 ... 280	6	9,6	2	200 ... 240	6	9,6	2
440 ... 520	6	9,6	3	280 ... 310	7,5	12,1	2,5	240 ... 280	7,5	12,1	2,5
520 ... 560	7,5	12,1	3	310 ... 480	9	14,5	3	280 ... 520	9	14,5	3
560 ... 670	9	14,5	3	480 ... 980	12	19,7	3	520 ... 600	9	14,5	3
560 ... 670	9	14,5	3	480 ... 980	12	19,7	3	520 ... 600	9	14,5	3
670 ... 1000	12	19,7	3,5					600 ... 980	12	19,7	3

Series 23200				Series 22300				Series 21300			
Outer diameter range	Dimensions			Outer diameter range	Dimensions			Outer diameter range	Dimensions		
	d0	a	b		d0	a	b		d0	a	b
mm				mm				mm			
250 ... 380	4,5	7,2	1,5	170 ... 225	4,5	7,2	1,5	... 200	4,5	7,2	1,5
380 ... 440	4,5	7,2	2	225 ... 280	6	9,6	2	200 ... 240	6	9,6	2
440 ... 520	6	9,6	3	280 ... 310	7,5	12,1	2,5	240 ... 280	7,5	12,1	2,5
520 ... 560	7,5	12,1	3	310 ... 480	9	14,5	3	280 ... 520	9	14,5	3
560 ... 670	9	14,5	3	480 ... 980	12	19,7	3	520 ... 600	9	14,5	3
560 ... 670	9	14,5	3	480 ... 980	12	19,7	3	520 ... 600	9	14,5	3

Number of lubrication holes - all series

Bore diameter range [mm]	50 ... 260	260 ... 460	460 ... 950
Number of lubrication holes	3	4	6

Equivalent dynamic radial load

$$P_r = F_r + Y_1 F_{a'} \text{ kN, for } F_a/F_r < e$$

$$P_r = 67 F_r + Y_2 F_{a'} \text{ kN, for } F_a/F_r > e$$

The values of the factors depending on the bearing type can be found in bearing tables.

Equivalent static radial load

$$P_{0r} = F_r + Y_0 * F_{a'} \text{ KN}$$

The value of the factor Y0 depending on the bearing type can be found in bearing tables.

Abutment dimensions

For a proper location of bearing rings on the shaft and housing shoulder respectively, shaft (housing) maximum connection radius $r_{u \text{ max}}$ should be less than bearing minimum mounting chamfer $r_{s \text{ min}}$.

Shoulder height should also be properly sized in case of bearing maximum mounting chamfer.

The values of the connection radii and support shoulder height are given in table 6. The mounting dimensions for bearings with withdrawal sleeves are given in table 6.

Abutment dimensions of spherical roller bearings

Table 6

rs min	ru max	hu max	
		Bearing series	
		230 239 240	231, 213, 241, 223, 222, 233, 232
mm			
1	1	2,3	2,8
1,1	1	3	3,5
1,5	1,5	3,5	4,5
2	2	4,4	5,5
2,1	2,1	5,1	6
3	2,5	6,2	7
4	3	7,3	8,5
5	4	9	10
6	5	11,5	13
7,5	6	14	16
9,5	8	17	20

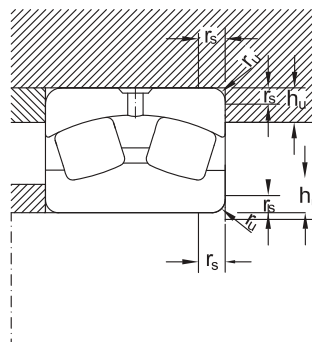
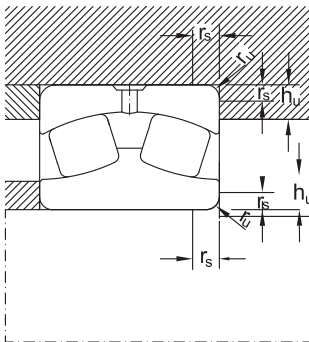

ART
BEARINGS

Spherical Roller Bearings

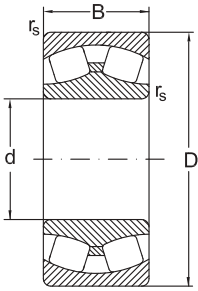

C

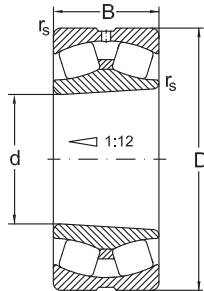

CKW33

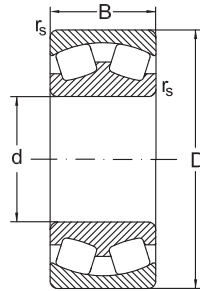

MB

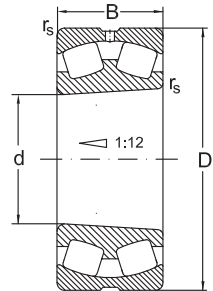

MBKW33

Dimensions				Basic radial load. Factors				
d	D	B	r _s min.	dyn. C _r	e	y ₁	y ₂	stat. C _{0r}
mm				kN				
25	52	18	1	43	0,35	1,8	2,9	46
	52	18	1	43	0,35	1,8	2,9	46
30	62	20	1	59	0,33	2	3,1	62
	62	20	1	59	0,33	2	3,1	62
35	72	23	1,1	81	0,32	2,1	3,1	88
	72	23	1,1	81	0,32	2,1	3,1	88
	80	21	1,5	66	0,28	2,4	3,6	65
	80	21	1,5	66	0,28	2,4	3,6	65
40	80	23	1,1	88	0,31	2,2	3,2	98
	80	23	1,1	88	0,31	2,2	3,2	98
	80	23	1,1	88	0,31	2,2	3,2	98
	80	23	1,1	78	0,31	2,2	3,2	87
	80	23	1,1	78	0,31	2,2	3,2	87
	80	23	1,1	78	0,31	2,2	3,2	87
	80	23	1,1	78	0,31	2,2	3,2	87
	80	23	1,1	78	0,31	2,2	3,2	87
	80	23	1,1	78	0,31	2,2	3,2	87
	90	23	1,5	99	0,26	2,6	3,9	120
	90	23	1,5	99	0,26	2,6	3,9	120
	90	23	1,5	99	0,26	2,6	3,9	120
	90	33	1,5	140	0,4	1,6	2,5	145
	90	33	1,5	140	0,4	1,6	2,5	145
	90	33	1,5	140	0,4	2,6	2,5	145
	90	33	1,5	140	0,4	2,5	2,5	145
90	33	1,5	140	0,4	1,6	2,5	145	
90	33	1,5	140	0,4	1,6	2,5	145	

Spherical Roller Bearings

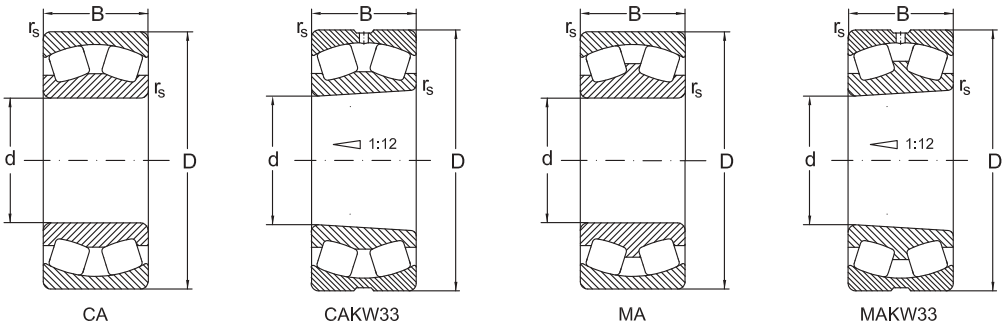

d	y ₀	Speed limit		Designation	Mass
		grease	oil		
mm		min ⁻¹		Bearing	kg
25	1,9	7500	10000	22205 CW33	0,182
	1,9	7500	10000	22205 CKW33	0,177
30	2	6300	8500	22206 CW33	0,287
	2	6300	8500	22206 CKW33	0,281
35	2	5300	7000	22207 CW33	0,438
	2	5300	7000	22207 CKW33	0,428
	2,4	5000	6400	21307 MBKW33	0,55
	2,4	5000	6400	21307 MBW33	0,56
40	2,1	4800	6300	22208 C	0,54
	2,1	4800	6300	22208 CK	0,54
	2,1	4800	6300	22208 CKW33	0,52
	2,1	4400	5800	22208 MAC4F80W33	0,654
	2,1	4400	5800	22208 MB	0,57
	2,1	4400	5800	22208 MBK	0,57
	2,1	4400	5800	22208 MBKW33	0,56
	2,1	4400	5800	22208 MBW33	0,56
	2,6	4500	6000	21308 C	0,71
	2,6	4500	6000	21308 CK	0,7
	2,6	4500	6000	21308 CKW33	0,7
	1,6	4300	5600	22308 C	0,97
	1,6	4300	5600	22308 CK	0,95
	1,6	4300	5600	22308 CKW33	0,93
	1,6	4300	5600	22308 CW33	0,96
	1,6	4300	5600	22308 CY	0,98
1,6	4300	5600	22308 CYK	0,95	

Spherical Roller Bearings

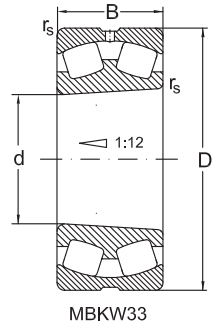
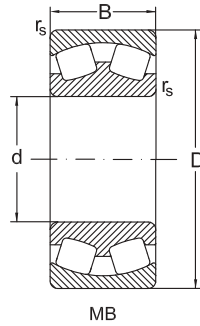
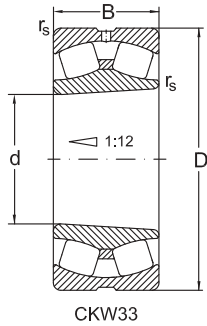
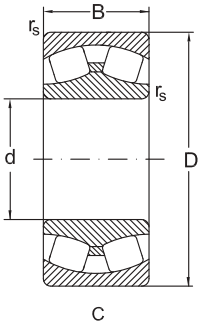

Dimensions				Basic radial load. Factors				
d	D	B	r _s min.	dyn. C _r	e	y ₁	y ₂	stat. C _{0r}
mm				kN				kN
40	90	33	1,5	140	0,4	1,6	2,5	145
	90	33	1,5	140	0,4	1,6	2,5	145
	90	33	1,5	125	0,4	1,7	2,5	135
	90	33	1,5	125	0,4	1,7	2,5	135
	90	33	1,5	125	0,4	1,7	2,5	135
	90	33	1,5	125	0,4	1,7	2,5	135
	90	33	1,5	125	0,4	1,7	2,5	135
45	85	23	1,1	93	0,26	2,6	3,4	105
	85	23	1,1	93	0,26	2,6	3,4	105
	85	23	1,1	93	0,26	2,6	3,4	105
	85	23	1,1	93	0,26	2,6	3,4	105
	85	23	1,1	77	0,28	2,4	3,5	87,5
	85	23	1,1	77	0,28	2,4	3,5	87,5
	85	23	1,1	77	0,28	2,4	3,5	87,5
	85	23	1,1	77	0,28	2,4	3,5	87,5
	100	25	1,5	120	0,26	2,6	3,9	135
	100	25	1,5	120	0,26	2,6	3,9	135
	100	25	1,5	120	0,26	2,6	3,9	135
	100	25	1,5	105	0,28	2,4	3,6	107
	100	36	1,5	165	0,35	1,9	2,9	190
	100	36	1,5	165	0,35	1,9	2,9	190
	100	36	1,5	165	0,35	1,9	2,9	190
	100	36	1,5	165	0,35	1,9	2,9	190
	100	36	1,5	150	0,4	1,7	2,5	175
100	36	1,5	150	0,4	1,7	2,5	175	

Spherical Roller Bearings

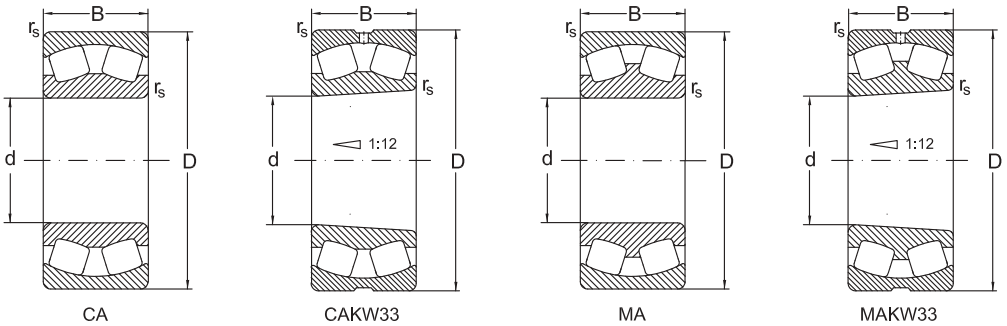

d	y ₀	Speed limit		Designation	Mass
		grease	oil		
mm		min ⁻¹		Bearing	kg
40	1,6	4300	5600	22308 CYKW33	0,94
	1,6	4300	5600	22308 CYW33	0,972
	1,6	3800	5000	22308 MAK4F80W33	1,42
	1,6	3800	5000	22308 MBK	1
	1,6	3800	5000	22308 MBKW33	0,99
	1,6	3800	5000	22308 MB	1,05
	1,6	3800	5000	22308 MBW33	1,01
45	2,5	4500	6000	22209 C	0,71
	2,5	4500	6000	22209 CK	0,7
	2,5	4500	6000	22209 CKW33	0,66
	2,5	4500	6000	22209 CW33	0,68
	2,3	4100	5500	22209 MBK	0,73
	2,3	4100	5500	22209 MBKW33	0,71
	2,3	4100	5500	22209 MB	0,77
	2,3	4100	5500	22209 MBW33	0,75
	2,6	4000	5300	21309 C	0,94
	2,6	4000	5300	21309 CK	0,93
	2,6	4000	5300	21309 CKW33	0,93
	2,3	3600	4800	21309 MB	0,94
	1,9	3800	5000	22309 C	1,33
	1,9	3800	5000	22309 CK	1,3
	1,9	3800	5000	22309 CKW33	1,3
	1,9	3800	5000	22309 CW33	1,33
	1,6	3400	4500	22309 MBK	1,37
1,6	3400	4500	22309 MBKW33	1,32	

Spherical Roller Bearings

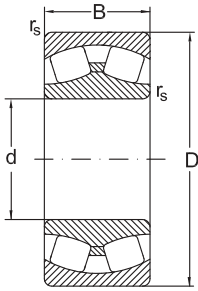

C

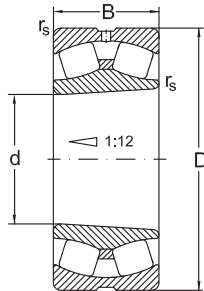

CKW33

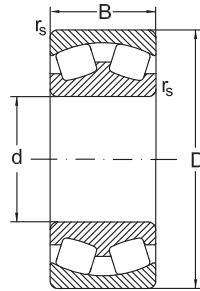

MB

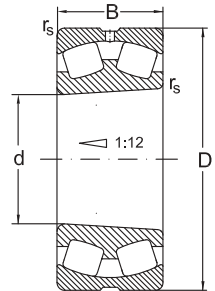

MBKW33

Dimensions				Basic radial load. Factors				
d	D	B	r _s min.	dyn. C _r	e	y ₁	y ₂	stat. C _{0r}
mm				kN	kN			
45	100	36	1,5	150	0,4	1,7	2,5	175
	100	36	1,5	150	0,4	1,7	2,5	175
50	90	23	1,1	100	0,24	2,9	4,2	120
	90	23	1,1	100	0,24	2,9	4,2	120
	90	23	1,1	100	0,24	2,9	4,2	120
	90	23	1,1	100	0,24	2,9	4,2	120
	90	23	1,1	100	0,24	2,9	4,2	120
	90	23	1,1	78	0,26	2,6	3,8	91,3
	90	23	1,1	78	0,26	2,6	3,8	91,3
	90	23	1,1	78	0,26	2,6	3,8	91,3
	90	23	1,1	78	0,26	2,6	3,8	91,3
	110	27	2	120	0,24	2,8	4,1	130
	110	27	2	120	0,24	2,8	4,1	130
	110	27	2	120	0,24	2,8	4,1	130
	110	40	2	190	0,38	1,8	2,7	220
	110	40	2	190	0,38	1,8	2,7	220
	110	40	2	190	0,38	1,8	2,7	220
	110	40	2	190	0,38	1,8	2,7	220
	110	40	2	190	0,38	1,8	2,7	220
	110	40	2	190	0,38	1,8	2,7	220
	110	40	2	190	0,38	1,8	2,7	202
	110	40	2	177	0,4	1,7	2,5	202
110	40	2	177	0,4	1,7	2,5	202	
110	40	2	177	0,4	1,7	2,5	202	
110	40	2	177	0,4	1,7	2,5	202	

Spherical Roller Bearings

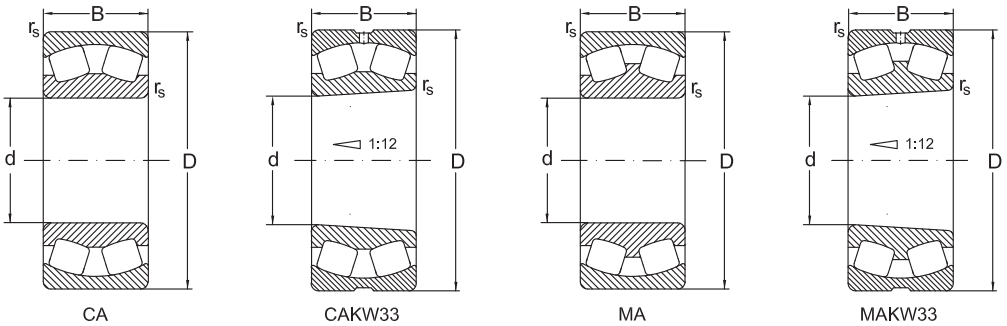

d	y_0	Speed limit		Designation	Mass
		grease	oil		
mm		min ⁻¹		Bearing	kg
45	1,6	3400	4500	22309 MB	1,37
	1,6	3400	4500	22309 MBW33	1,35
50	2,7	4000	5300	22210 C	0,74
	2,7	4000	5300	22210 CK	0,7
	2,7	4000	5300	22210 CKW33	0,69
	2,7	4000	5300	22210 CW33	0,72
	2,5	3600	4800	22210 MBK	0,76
	2,5	3600	4800	22210 MBKW33	0,75
	2,5	3600	4800	22210 MB	0,77
	2,5	3600	4800	22210 MBW33	0,76
	2,7	3600	4800	21310 C	1,25
	2,7	3600	4800	21310 CK	1,2
	2,7	3600	4800	21310 CKW33	1,2
	1,7	3400	4500	22310 C	1,81
	1,7	3400	4500	22310 CK	1,77
	1,7	3400	4500	22310 CKW33	1,76
	1,7	3400	4500	22310 CW33	1,8
	1,7	3400	4500	22310 CY	1,82
	1,7	3400	4500	22310 CYK	1,81
	1,7	3400	4500	22310 CYKW33	1,77
	1,7	3400	4500	22310 CYW33	1,81
	1,6	3000	4000	22310 MBK	1,84
1,6	3000	4000	22310 MBKW33	1,83	
1,6	3000	4000	22310 MAC4F80W33	1,83	
1,6	3000	4000	22310 MB	1,85	

Spherical Roller Bearings

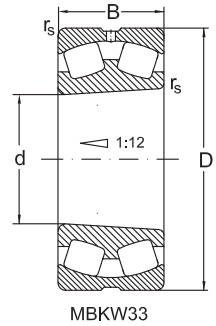
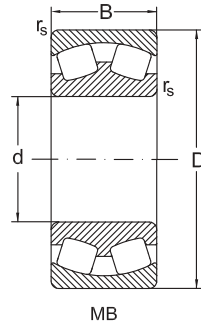
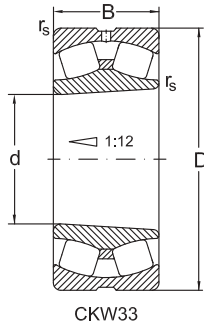
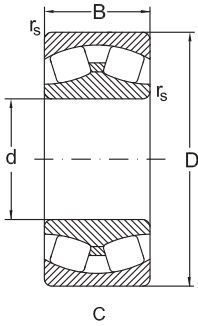

Dimensions				Basic radial load. Factors					
d	D	B	r_s min.	dyn. C_r	e	y_1	y_2	stat. C_{0r}	
mm				kN				kN	
50	110	40	2	177	0,4	1,7	2,5	202	
	55	100	25	1,5	120	0,27	2,7	4,1	140
		100	25	1,5	120	0,27	2,7	4,1	140
		100	25	1,5	120	0,27	2,7	4,1	140
		100	25	1,5	120	0,27	2,7	4,1	140
		100	25	1,5	94	0,26	2,6	3,9	107
		100	25	1,5	94	0,26	2,6	3,9	107
		100	25	1,5	94	0,26	2,6	3,9	107
		100	25	1,5	94	0,26	2,6	3,9	107
	120	29	2	135	0,24	2,8	4,1	155	
120	29	2	135	0,24	2,8	4,1	155		
55	120	43	2	230	0,4	1,7	2,5	265	
	120	43	2	230	0,4	1,7	2,5	265	
	120	43	2	230	0,4	1,7	2,5	265	
	120	43	2	230	0,4	1,7	2,5	265	
	120	43	2	230	0,4	1,7	2,5	265	
	120	43	2	230	0,4	1,7	2,5	265	
	120	43	2	230	0,4	1,7	2,5	265	
	120	43	2	230	0,4	1,7	2,5	265	
	120	43	2	230	0,4	1,7	2,5	265	
	120	43	2	220	0,4	1,7	2,5	255	
	120	43	2	220	0,4	1,7	2,5	255	
	120	43	2	220	0,4	1,7	2,5	255	

Spherical Roller Bearings

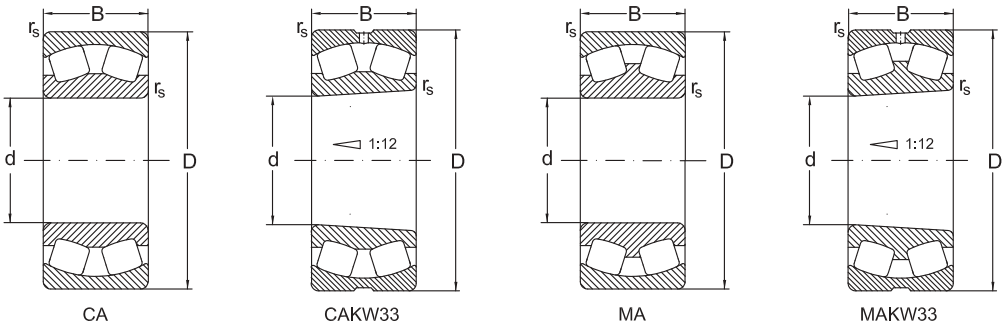

d	y ₀	Speed limit		Designation	Mass
		grease	oil		
mm		min ⁻¹		Bearing	kg
50	1,6	3000	4000	22310 MBW33	1,84
	2,7	3800	5000	22211 C	0,93
	2,7	3800	5000	22211 CK	0,9
	2,7	3800	5000	22211 CKW33	0,87
	2,7	3800	5000	22211 CW33	0,89
	2,5	3600	4600	22211 MBK	0,89
	2,5	3600	4600	22211 MBKW33	0,88
	2,5	3600	4600	22211 MB	0,91
	2,5	3600	4600	22211 MBW33	0,89
	2,7	3200	4300	21311 C	1,65
55	2,7	3200	4300	21311 CK	1,6
	1,6	3000	4000	22311 C	2,32
	1,6	3000	4000	22311 CK	2,27
	1,6	3000	4000	22311 CKW33	2,25
	1,6	3000	4000	22311 CW33	2,32
	1,6	3000	4000	22311 CY	2,34
	1,6	3000	4000	22311 CYK	2,28
	1,6	3000	4000	22311 CYKW33	2,26
	1,6	3000	4000	22311 CYW33	2,32
	1,6	2800	3600	22311 MBK	2,1
	1,6	2800	3600	22311 MAKW33	2,44
	1,6	2800	3600	22311 MA	2,49
	1,6	2800	3600	22311 MAC4F80W33	2,42
	1,6	2800	3600	22311 MAC4W502	2,44
1,6	2800	3600	22311 MAW502	2,44	

Spherical Roller Bearings

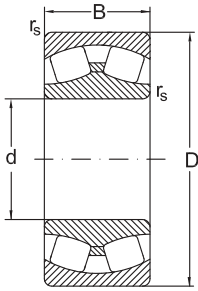

C

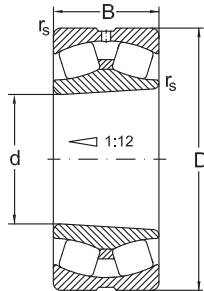

CKW33

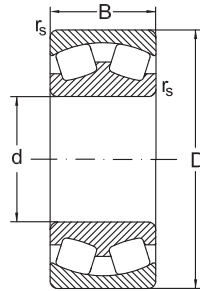

MB

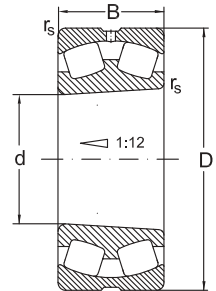

MBKW33

Dimensions				Basic radial load. Factors				
d	D	B	r_s min.	dyn. C_r	e	y_1	y_2	stat. C_{0r}
mm				kN				
55	120	43	2	220	0,4	1,7	2,5	255
	120	43	2	220	0,4	1,7	2,5	255
60	110	28	1,5	145	0,27	2,7	4	175
	110	28	1,5	145	0,27	2,7	4	175
	110	28	1,5	145	0,27	2,7	4	175
	110	28	1,5	117,8	0,27	2,6	3,8	140,3
	110	28	1,5	117,8	0,27	2,6	3,8	140,3
	110	28	1,5	117,8	0,27	2,6	3,8	140,3
	110	28	1,5	117,8	0,27	2,6	3,8	140,3
	130	31	2,1	150	0,24	2,9	4,3	180
	130	31	2,1	150	0,24	2,9	4,3	180
	130	31	2,1	151	0,24	2,9	4,3	152
	130	46	2,1	270	0,4	1,7	2,5	320
	130	46	2,1	270	0,4	1,7	2,5	320
	130	46	2,1	270	0,4	1,7	2,5	320
	130	46	2,1	270	0,4	1,7	2,5	320
	130	46	2,1	270	0,4	1,7	2,5	320
	130	46	2,1	270	0,4	1,7	2,5	320
	130	46	2,1	260	0,4	1,7	2,5	310
	130	46	2,1	260	0,4	1,7	2,5	310
130	46	2,1	260	0,4	1,7	2,5	310	
130	46	2,1	260	0,4	1,7	2,5	310	

Spherical Roller Bearings

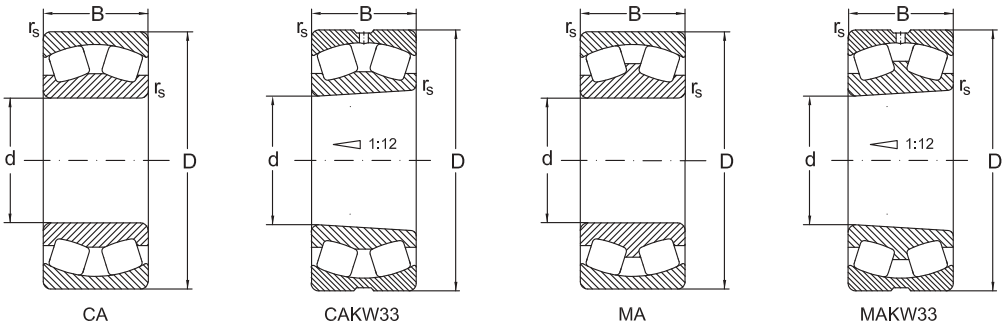

d	y ₀	Speed limit		Designation	Mass
		grease	oil	Bearing	
mm		min ⁻¹			kg
55	1,6	2800	3600	22311 MB	2,43
	1,6	2800	3600	22311 MBW33	2,42
60	2,7	3400	4500	22212 C	1,32
	2,7	3400	4500	22212 CK	1,29
	2,7	3400	4500	22212 CKW33	1,25
	2,5	3200	4100	22212 MBK	1,19
	2,5	3200	4100	22212 MBKW33	1,17
	2,5	3200	4100	22212 MB	1,22
	2,5	3200	4100	22212 MBW33	1,2
	2,8	3000	4000	21312 C	1,95
	2,8	3000	4000	21312 CK	1,9
	2,8	2800	3800	21312 MBK	2,13
	1,7	2800	3800	22312 C	2,91
	1,7	2800	3800	22312 CK	2,84
	1,7	2800	3800	22312 CKW33	2,8
	1,7	2800	3800	22312 CW33	2,87
	1,7	2800	3800	22312 CY	2,93
	1,7	2800	3800	22312 CYK	2,86
	1,7	2800	3800	22312 CYKW33	2,82
	1,7	2800	3800	22312 CYW33	2,89
	1,7	2600	3400	22312 MBK	3,04
	1,7	2600	3400	22312 MBKW33	3
1,7	2600	3400	22312 MAC4F80W33	3,07	
1,7	2600	3400	22312 MB	3,04	
1,7	2600	3400	22312 MBW33	3	

Spherical Roller Bearings

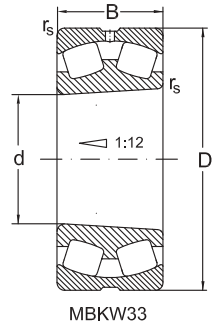
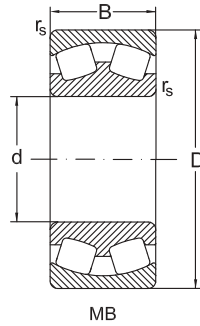
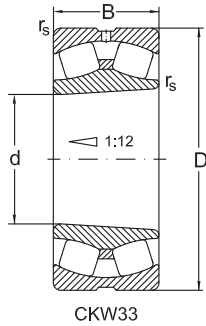
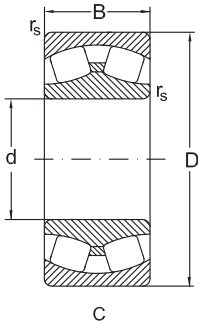

Dimensions				Basic radial load. Factors				
d	D	B	r _s min.	dyn. C _r	e	y ₁	y ₂	stat. C _{0r}
mm				kN				
65	120	31	1,5	180	0,28	2,4	3,6	220
	120	31	1,5	180	0,28	2,4	3,6	220
	120	31	1,5	180	0,28	2,4	3,6	220
	120	31	1,5	180	0,28	2,4	3,6	220
	120	31	1,5	165	0,28	2,4	3,6	200
	120	31	1,5	165	0,28	2,4	3,6	200
	120	31	1,5	165	0,28	2,4	3,6	200
	120	31	1,5	165	0,28	2,4	3,6	200
	140	33	2,1	220	0,24	2,8	4,2	290
	140	33	2,1	220	0,24	2,8	4,2	290
	140	48	2,1	305	0,39	1,7	2,6	360
	140	48	2,1	305	0,39	1,7	2,6	360
	140	48	2,1	305	0,39	1,7	2,6	360
	140	48	2,1	305	0,39	1,7	2,6	360
	140	48	2,1	305	0,39	1,7	2,6	360
	140	48	2,1	305	0,39	1,7	2,6	360
	140	48	2,1	305	0,39	1,7	2,6	360
	140	48	2,1	280	0,39	1,7	2,6	360
	140	48	2,1	280	0,39	1,7	2,6	330
	140	48	2,1	280	0,39	1,7	2,6	330
	140	48	2,1	280	0,39	1,7	2,6	330
	140	48	2,1	280	0,39	1,7	2,6	330
	140	48	2,1	280	0,39	1,7	2,6	330
	140	48	2,1	280	0,39	1,7	2,6	330

Spherical Roller Bearings

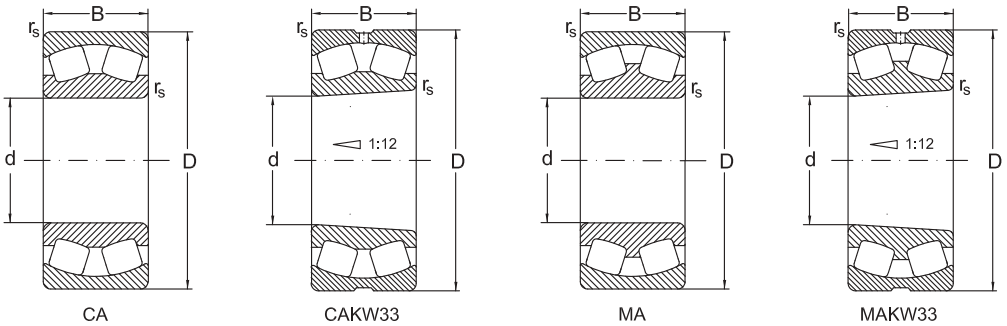

d	y ₀	Speed limit		Designation	Mass
		grease	oil	Bearing	
mm		min ⁻¹			kg
65	2,4	3000	4000	22213 C	1,73
	2,4	3000	4000	22213 CK	1,71
	2,4	3000	4000	22213 CKW33	1,65
	2,4	3000	4000	22213 CW33	1,68
	2,4	2800	3600	22213 MBK	1,59
	2,4	2800	3600	22213 MBKW33	1,57
	2,4	2800	3600	22213 MB	1,62
	2,4	2800	3600	22213 MBW33	1,6
	2,8	2800	3800	21313 C	2,47
	2,8	2800	3800	21313 CK	2,43
	1,7	2800	3600	22313 C	3,57
	1,7	2800	3600	22313 CK	3,49
	1,7	2800	3600	22313 CKW33	3,44
	1,7	2800	3600	22313 CW33	3,51
	1,7	2800	3600	22313 CY	3,54
	1,7	2800	3600	22313 CYK	3,44
	1,7	2800	3600	22313 CYKW33	3,43
	1,7	2800	3600	22313 CYW33	3,53
	1,7	2400	3200	22313 MB	3,81
	1,7	2400	3200	22313 MBW33	3,7
	1,7	2400	3200	22313 MBK	3,71
	1,7	2400	3200	22313 MBKW33	3,65
	1,7	2400	3200	22313 MA	3,56
1,7	2400	3200	22313 MAC4F80W33	3,77	
1,7	2400	3200	22313 MAC4W502	3,51	

Spherical Roller Bearings

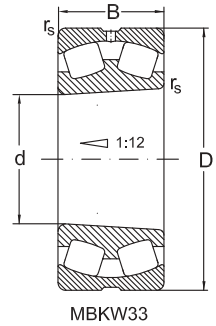
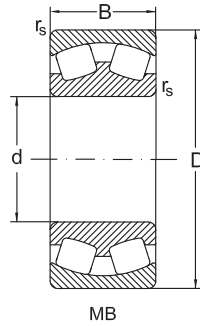
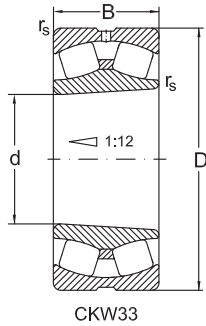
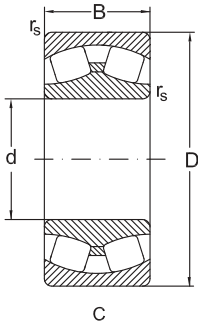

Dimensions				Basic radial load. Factors					
d	D	B	r _s min.	dyn. C _r	e	y ₁	y ₂	stat. C _{0r}	
mm				kN				kN	
65	140	48	2,1	280	0,39	1,7	2,6	330	
	125	31	1,5	180	0,26	2,6	3,9	225	
	125	31	1,5	180	0,26	2,6	3,9	225	
	125	31	1,5	180	0,26	2,6	3,9	225	
	125	31	1,5	180	0,26	2,6	3,9	225	
	150	35	2,1	190	0,26	2,6	4	197	
	150	35	2,1	190	0,26	2,6	4	197	
	150	35	2,1	190	0,26	2,6	4	197	
	70	150	51	2,1	375	0,38	1,9	2,9	455
		150	51	2,1	375	0,38	1,9	2,9	455
150		51	2,1	375	0,38	1,9	2,9	455	
150		51	2,1	375	0,38	1,9	2,9	455	
150		51	2,1	340	0,37	1,8	2,7	420	
150		51	2,1	340	0,37	1,8	2,7	420	
150		51	2,1	340	0,37	1,8	2,7	420	
150		51	2,1	340	0,37	1,8	2,7	420	
150		51	2,1	340	0,37	1,8	2,7	420	
150		51	2,1	340	0,37	1,8	2,7	420	
75	130	31	1,5	190	0,23	2,9	4,4	250	
	130	31	1,5	190	0,23	2,9	4,4	250	
	130	31	1,5	190	0,24	2,9	4,4	250	
	130	31	1,5	190	0,24	2,9	4,4	250	
	130	31	1,5	175	0,24	2,8	4,1	230	
	130	31	1,5	175	0,24	2,8	4,1	230	
	130	31	1,5	175	0,24	2,8	4,1	230	
	130	31	1,5	175	0,24	2,8	4,1	230	

Spherical Roller Bearings

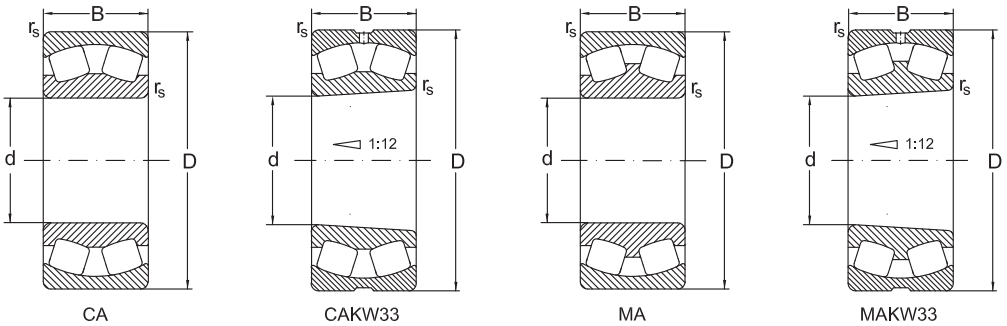

d	y ₀	Speed limit		Designation	Mass	
		grease	oil	Bearing		
mm		min ⁻¹			kg	
65	1,7	2400	3200	22313 MAW502	3,51	
	2,6	2800	3800	22214 C	1,82	
	2,6	2800	3800	22214 CK	1,82	
	2,6	2800	3800	22214 CKW33	1,8	
	2,6	2800	3800	22214 CW33	1,82	
	2,6	2600	3400	21314 MBKW33	3,12	
	2,6	2600	3400	21314 MB	3,2	
	2,6	2600	3400	21314 MBW33	3,16	
70	1,9	2400	3200	22314 C	4,32	
	1,9	2400	3200	22314 CK	4,32	
	1,9	2400	3200	22314 CKW33	4,21	
	1,9	2400	3200	22314 CW33	4,3	
	1,7	2200	2800	22314 MB	4,51	
	1,7	2200	2800	22314 MBW33	4,51	
	1,7	2200	2800	22314 MBK	4,37	
	1,7	2200	2800	22314 MBKW33	4,37	
	1,7	2200	2800	22314 MAC4F80W33	4,58	
	1,7	2200	2800	22314 MBW7	4,53	
	75	2,9	2800	3800	22215 C	1,91
		2,9	2800	3800	22215 CK	1,88
2,9		2800	3800	22215 CW33	1,89	
2,9		2800	3800	22215 CKW33	1,86	
2,7		2600	3400	22215 MBK	1,75	
2,7		2600	3400	22215 MBKW33	1,73	
2,7		2600	3400	22215 MB	1,79	

Spherical Roller Bearings

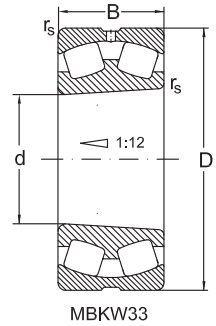
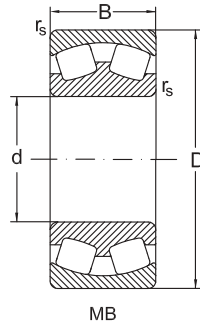
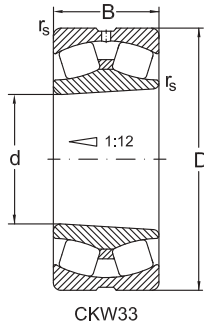
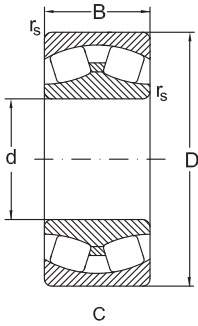

Dimensions				Basic radial load. Factors				
d	D	B	r_s min.	dyn. C_r	e	y_1	y_2	stat. C_{0r}
mm				kN	kN			
75	130	31	1,5	175	0,24	2,8	4,1	230
	160	37	2,1	280	0,23	2,9	4,4	360
	160	37	2,1	280	0,23	2,9	4,4	360
	160	55	2,1	415	0,38	1,8	2,6	520
	160	55	2,1	415	0,38	1,8	2,6	520
	160	55	2,1	415	0,38	1,8	2,6	520
	160	55	2,1	415	0,38	1,8	2,6	520
	160	55	2,1	380	0,34	1,9	2,9	475
	160	55	2,1	380	0,34	1,9	2,9	475
	160	55	2,1	380	0,34	1,9	2,9	475
	160	55	2,1	380	0,34	1,9	2,9	475
	160	55	2,1	380	0,34	1,9	2,9	475
80	140	33	2	210	0,25	2,6	4	275
	140	33	2	210	0,25	2,6	4	275
	140	33	2	210	0,25	2,6	4	275
	140	33	2	210	0,25	2,6	4	275
	140	33	2	210	0,25	2,6	4	275
	140	33	2	210	0,25	2,6	4	275
	140	33	2	210	0,25	2,6	4	275
	140	33	2	210	0,25	2,6	4	275
	140	33	2	195	0,24	2,8	4,1	250
	140	33	2	195	0,24	2,8	4,1	250
	140	33	2	195	0,24	2,8	4,1	250
	140	33	2	195	0,24	2,8	4,1	250
	170	39	2,1	310	0,23	2,9	4,2	400

Spherical Roller Bearings

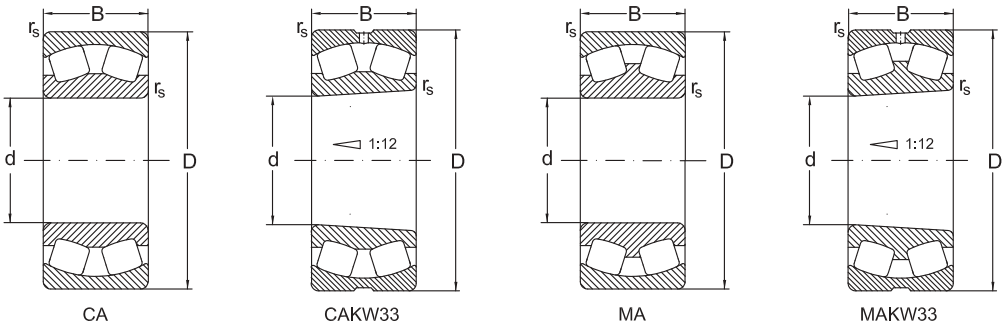

d	y ₀	Speed limit		Designation	Mass
		grease	oil	Bearing	
mm		min ⁻¹			kg
75	2,7	2600	3400	22215 MBW33	1,77
	2,9	2400	3200	21315 CW33	3,78
	2,9	2400	3200	21315 CKW33	3,73
	1,7	2200	3000	22315 C	5,28
	1,7	2200	3000	22315 CW33	5,26
	1,7	2200	3000	22315 CK	5,16
	1,7	2200	3000	22315 CKW33	5,14
	1,9	1900	2600	22315 MBK	5,14
	1,9	1900	2600	22315 MBKW33	5,12
	1,9	1900	2600	22315 MAC4F80W33	5,57
	1,9	1900	2600	22315 MB	5,26
	1,9	1900	2600	22315 MBW33	5,24
80	2,6	2600	3400	22216 C	2,12
	2,6	2600	3400	22216 CW33	2,1
	2,6	2600	3400	22216 CK	2,07
	2,6	2600	3400	22216 CKW33	2,05
	2,6	2600	3400	22216 CY	2,13
	2,6	2600	3400	22216 CYK	2,13
	2,6	2600	3400	22216 CYKW33	2,06
	2,6	2600	3400	22216 CYW33	2,11
	2,7	2400	3200	22216 MBK	2,09
	2,7	2400	3200	22216 MBKW33	2,07
	2,7	2400	3200	22216 MB	2,14
	2,7	2200	3000	22216 MBW33	2,1
	2,8	2200	3000	21316 CW33	4,26

Spherical Roller Bearings

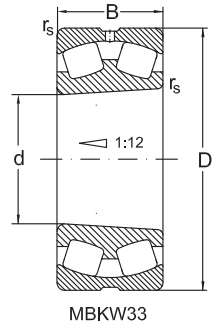
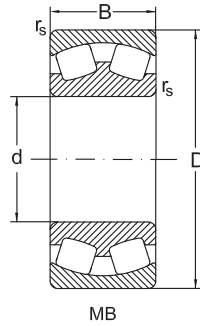
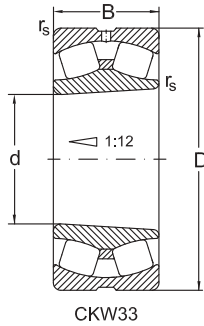
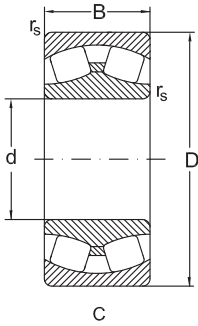

Dimensions				Basic radial load. Factors				
d	D	B	r _s min.	dyn. C _r	e	y ₁	y ₂	stat. C _{0r}
mm				kN	kN			
80	170	39	2,1	310	0,23	2,9	4,2	400
	170	58	2,1	450	0,35	1,9	2,9	550
	170	58	2,1	450	0,35	1,9	2,9	550
	170	58	2,1	450	0,35	1,9	2,9	550
	170	58	2,1	450	0,35	1,9	2,9	550
	170	58	2,1	410	0,25	2,6	4	500
	170	58	2,1	410	0,25	2,6	4	500
	170	58	2,1	410	0,25	2,6	4	500
	170	58	2,1	410	0,25	2,6	4	500
	170	58	2,1	410	0,25	2,6	4	500
85	150	36	2	250	0,26	2,6	3,9	325
	150	36	2	250	0,26	2,6	3,9	325
	150	36	2	250	0,26	2,6	3,9	325
	150	36	2	250	0,26	2,6	3,9	325
	150	36	2	230	0,25	2,7	4	295
	150	36	2	230	0,25	2,7	4	295
	150	36	2	230	0,25	2,7	4	295
	150	36	2	230	0,25	2,7	4	295
	150	36	2	230	0,25	2,7	4	295
	180	41	3	233,4	0,22	3	4,5	244
	180	41	3	350	0,22	3	4,5	450
	180	41	3	350	0,22	3	4,5	450
	180	60	3	500	0,33	2	3	620
	180	60	3	500	0,33	2	3	620
180	60	3	500	0,33	2	3	620	

Spherical Roller Bearings

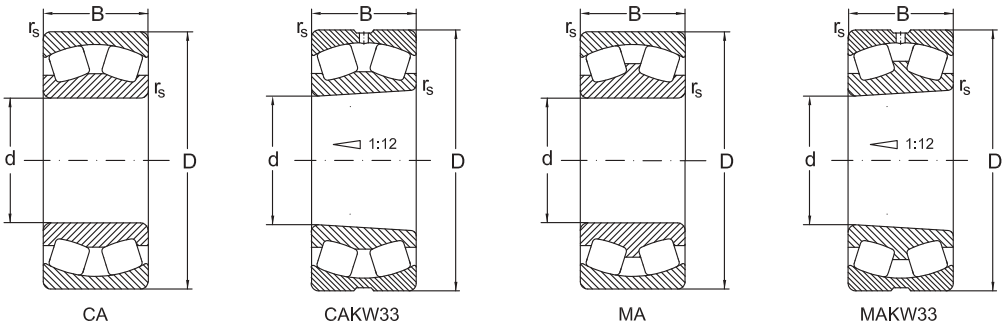

d	y ₀	Speed limit		Designation	Mass
		grease	oil	Bearing	
mm		min ⁻¹			kg
80	2,8	2200	3000	21316 CKW33	4,2
	1,8	2000	2600	22316 C	6,33
	1,8	2000	2600	22316 CK	6,14
	1,8	2000	2600	22316 CKW33	6,12
	1,8	2000	2600	22316 CW33	6,27
	2,6	1800	2400	22316 MAC4F80W33	6,95
	2,6	1800	2400	22316 MBK	6,11
	2,6	1800	2400	22316 MB	6,25
	2,6	1800	2400	22316 MBW33	6,23
	2,6	1800	2400	22316 MBKW33	6,09
85	2,6	2400	3200	22217 C	2,57
	2,6	2400	3200	22217 CK	2,52
	2,6	2400	3200	22217 CW33	2,56
	2,6	2400	3200	22217 CKW33	2,5
	2,6	2200	2800	22217 MB	2,76
	2,6	2200	2800	22217 MBK	2,7
	2,6	2200	2800	22217 MBKW33	2,69
	2,6	2200	2800	22217 MBW7	2,76
	2,6	2200	2800	22217 MBW33	2,75
	2,9	2100	2600	21317 MBKW33	5,1
	2,9	2200	2800	21317 C	5,1
	2,9	2200	2800	21317 CK	5
	2	1800	2400	22317 C	7,68
	2	1800	2400	22317 CK	7,52
	2	1800	2400	22317 CKW33	7,47

Spherical Roller Bearings

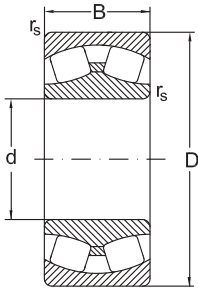

C

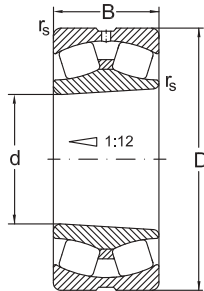

CKW33

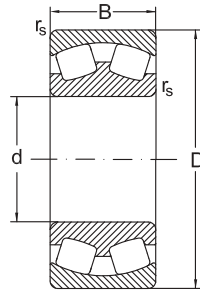

MB

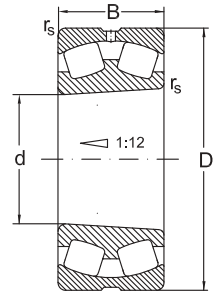

MBKW33

Dimensions				Basic radial load. Factors				
d	D	B	r_s min.	dyn. C_r	e	y_1	y_2	stat. C_{0r}
mm				kN	kN			
85	180	60	3	460	0,22	3	4,5	570
	180	60	3	406	0,37	1,8	2,7	507
	180	60	3	406	0,37	1,8	2,7	507
	180	60	3	406	0,37	1,8	2,7	507
	180	60	3	406	0,37	1,8	2,7	507
	180	60	3	406	0,37	1,8	2,7	507
	180	60	3	406	0,37	1,8	2,7	507
90	160	40	2	305	0,27	2,5	3,8	410
	160	40	2	305	0,27	2,5	3,8	410
	160	40	2	305	0,27	2,5	3,8	410
	160	40	2	305	0,27	2,5	3,8	410
	160	40	2	305	0,27	2,5	3,8	410
	160	40	2	305	0,27	2,5	3,8	410
	160	40	2	305	0,27	2,5	3,8	410
	160	40	2	305	0,27	2,5	3,8	410
	160	40	2	280	0,26	2,6	3,8	375
	160	40	2	280	0,26	2,6	3,8	375
	160	40	2	280	0,26	2,6	3,8	375
	160	40	2	280	0,26	2,6	3,8	375
	160	52,4	2	340	0,34	2	3	485
	160	52,4	2	340	0,34	2	3	485
	160	52,4	2	340	0,34	2	3	485
	160	52,4	2	340	0,34	2	3	485
	190	43	3	385	0,22	3	4,5	510
190	43	3	385	0,22	3	4,5	510	

Spherical Roller Bearings

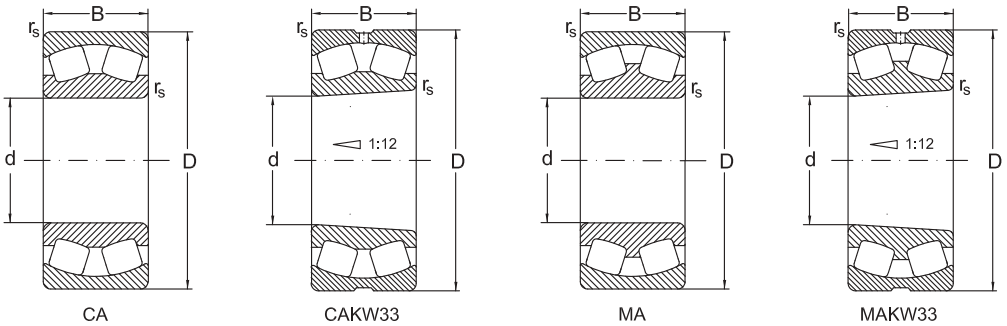

d	y ₀	Speed limit		Designation	Mass
		grease	oil		
mm		min ⁻¹		Bearing	kg
85	2,9	2200	2800	22317 CA	7,64
	1,8	1800	2400	22317 MBW33	7,17
	1,8	1700	2200	22317 MBK	7,07
	1,8	1700	2200	22317 MAC4F80W33	7,88
	1,8	1700	2200	22317 MB	7,33
	1,8	1700	2200	22317 MBW20	7,23
	1,8	1700	2200	22317 MBKW33	7,01
90	2,5	2200	3000	22218 C	3,4
	2,5	2200	3000	22218 CW33	3,38
	2,5	2200	3000	22218 CK	3,33
	2,5	2200	3000	22218 CKW33	3,31
	2,5	2200	3000	22218 CY	3,41
	2,5	2200	3000	22218 CYK	3,34
	2,5	2200	3000	22218 CYKW33	3,33
	2,5	2200	3000	22218 CYW33	3,39
	2,5	2200	2800	22218 MBK	3,47
	2,5	2200	2800	22218 MBKW33	3,46
	2,5	2200	2800	22218 MBW33	3,46
	2,5	2200	2800	22218 MB	3,57
	2	1500	2000	23218 MBKW33	4,23
	2	1500	2000	23218 MB	4,37
	2	1500	2000	23218 MBK	4,25
	2	1500	2000	23218 MBW33	4,35
	2,9	2200	2800	21318 C	5,8
2,9	2200	2800	21318 CK	5,7	

Spherical Roller Bearings

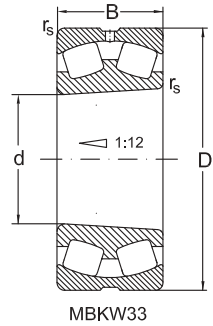
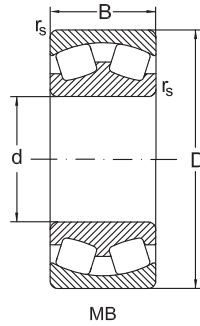
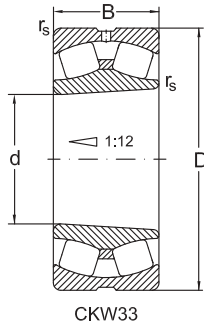
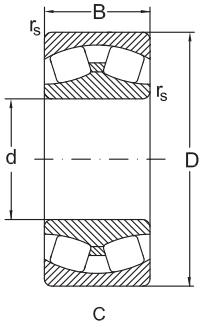

Dimensions				Basic radial load. Factors				
d	D	B	r _s min.	dyn. C _r	e	y ₁	y ₂	stat. C _{0r}
mm				kN				
90	190	64	3	570	0,36	1,9	2,8	730
	190	64	3	570	0,36	1,9	2,8	730
	190	64	3	570	0,36	1,9	2,8	730
	190	64	3	570	0,36	1,9	2,8	730
	190	64	3	570	0,36	1,9	2,8	730
	190	64	3	570	0,36	1,9	2,8	730
	190	64	3	570	0,36	1,9	2,8	730
	190	64	3	570	0,36	1,9	2,8	730
	190	64	3	530	0,37	1,8	2,7	670
	190	64	3	530	0,37	1,8	2,7	670
	190	64	3	530	0,37	1,8	2,7	670
	190	64	3	530	0,37	1,8	2,7	670
	190	64	3	530	0,37	1,8	2,7	670
	190	64	3	530	0,37	1,8	2,7	670
95	170	43	2,1	340	0,24	2,8	4,2	450
	170	43	2,1	340	0,24	2,8	4,2	450
	170	43	2,1	340	0,24	2,8	3,8	450
	170	43	2,1	340	0,24	2,8	4,2	450
	170	43	2,1	340	0,24	2,8	4,2	450
	170	43	2,1	310	0,26	2,6	3,8	415
	170	43	2,1	310	0,26	2,6	3,8	415
	170	43	2,1	310	0,26	2,6	3,8	415
	170	43	2,1	310	0,26	2,6	3,8	415
	200	45	3	420	0,22	3	4,5	580
	200	45	3	385	0,22	3,1	4,6	530



Spherical Roller Bearings

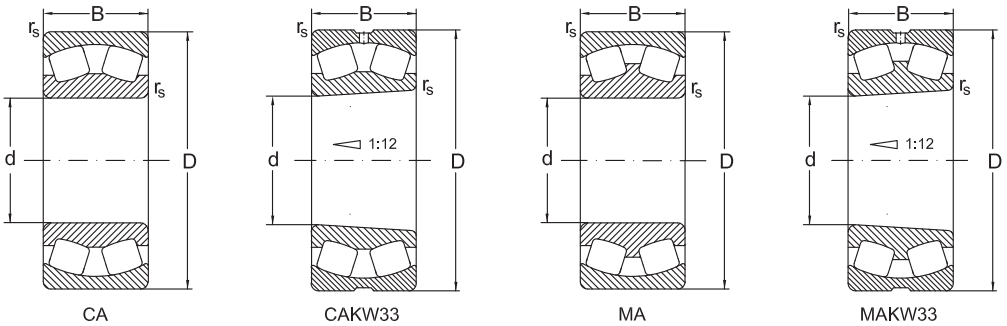

d	y ₀	Speed limit		Designation	Mass
		grease	oil		
mm		min ⁻¹		Bearing	kg
90	1,8	1800	2400	22318 C	8,68
	1,8	1800	2400	22318 CK	8,5
	1,8	1800	2400	22318 CW33	8,6
	1,8	1800	2400	22318 CKW33	8,5
	1,8	1800	2400	22318 CY	8,73
	1,8	1800	2400	22318 CYK	8,55
	1,8	1800	2400	22318 CYKW33	8,53
	1,8	1800	2400	22318 CYW33	8,71
	1,8	1700	2200	22318 MBK	8,5
	1,8	1700	2200	22318 MBKW33	8,49
	1,8	1700	2200	22318 MA	9,21
	1,8	1700	2200	22318 MAC4F80W33	9,2
	1,8	1700	2200	22318 MB	8,69
	1,8	1700	2200	22318 MBW33	8,68
95	2,8	2200	2800	22219 C	4,26
	2,8	2200	2800	22219 CK	4,17
	2,8	2200	2800	22219 CKW33	4,15
	2,8	2200	2800	22219 CW25	4,24
	2,8	2200	2800	22219 CW33	4,24
	2,5	2000	2600	22219 MBK	4,3
	2,5	2000	2600	22219 MBKW33	4,28
	2,5	2000	2600	22219 MB	4,32
	2,5	2000	2600	22219 MBW25	4,32
	3	2000	2600	21319 CA	7,43
	3	2000	2600	21319 MB	7,38

Spherical Roller Bearings

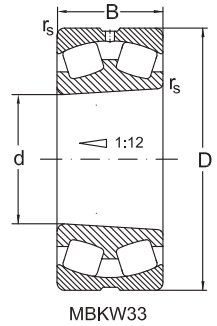
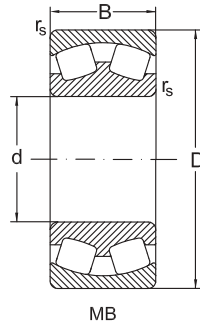
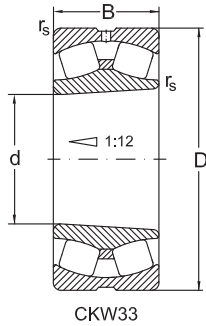
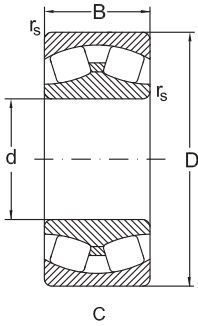

Dimensions				Basic radial load. Factors				
d	D	B	r _s min.	dyn. C _r	e	y ₁	y ₂	stat. C _{0r}
mm				kN	kN			
95	200	45	3	385	0,22	3,1	4,6	530
	200	67	3	620	0,35	1,9	2,9	800
	200	67	3	620	0,35	1,9	2,9	800
	200	67	3	620	0,35	1,9	2,9	800
	200	67	3	620	0,35	1,9	2,9	800
	200	67	3	620	0,35	1,9	2,9	800
	200	67	3	570	0,35	1,9	2,7	740
	200	67	3	570	0,38	1,8	2,7	740
	200	67	3	570	0,38	1,8	2,7	740
	200	67	3	570	0,38	1,8	2,7	740
	200	67	3	570	0,38	1,8	2,7	740
	200	67	3	570	0,38	1,8	2,7	740
100	165	52	2	347	0,28	2,4	3,5	534
	165	52	2	355	0,31	2,2	3,2	540
	165	52	2	355	0,31	2,2	3,2	540
	165	52	2	355	0,31	2,2	3,2	540
	165	52	2	355	0,31	2,2	3,2	540
	180	46	2,1	375	0,24	2,8	4,2	500
	180	46	2,1	375	0,24	2,8	4,2	500
	180	46	2,1	375	0,24	2,8	4,2	500
	180	46	2,1	375	0,24	2,8	4,2	500
	180	46	2,1	340	0,27	2,5	3,7	455
	180	46	2,1	340	0,27	2,5	3,7	455
	180	46	2,1	340	0,27	2,5	3,7	455

Spherical Roller Bearings

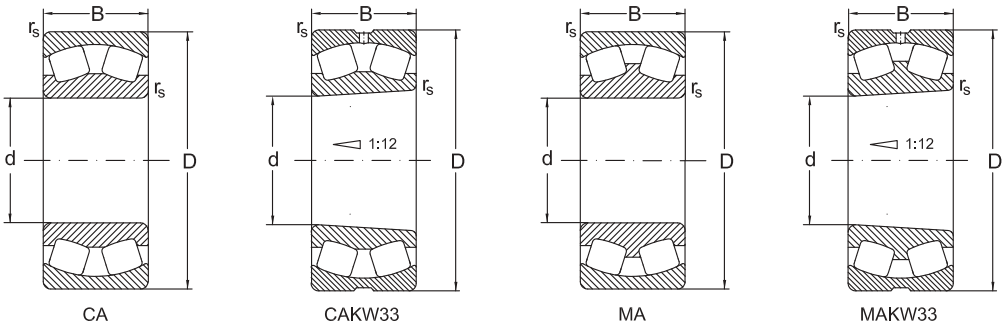

d	y ₀	Speed limit		Designation	Mass
		grease	oil		
mm		min ⁻¹		Bearing	kg
95	3	2000	2600	21319 MBK	7,28
	1,8	1700	2200	22319 C	8,83
	1,8	1700	2200	22319 CK	8,61
	1,8	1700	2200	22319 CKW33	8,5
	1,8	1700	2200	22319 CW25	8,71
	1,8	1700	2200	22319 CW33	8,72
	1,7	1500	2000	22319 MBK	9,88
	1,7	1500	2000	22319 MAC4F80W33	10,7
	1,7	1500	2000	22319 MB	10,1
	1,7	1500	2000	22319 MBW25	9,97
	1,7	1500	2000	22319 MBW33	9,97
	1,7	1500	2000	22319 MBKW33	9,97
100	2,3	2200	3000	23120 CW33	5
	2,1	2000	2600	23120 MBKW33	4,53
	2,1	2000	2600	23120 MB	4,7
	2,1	2000	2600	23120 MBK	4,57
	2,1	2000	2600	23120 MBW33	4,66
	2,8	2200	2800	22220 C	5,24
	2,8	2200	2800	22220 CK	5,13
	2,8	2200	2800	22220 CKW33	5,09
	2,8	2200	2800	22220 CW33	5,23
	2,4	2000	2600	22220 MBK	5,24
	2,4	2000	2600	22220 MB	5,35
	2,4	2000	2600	22220 MBW33	5,31
	2,4	2000	2600	22220 MBKW33	5,2

Spherical Roller Bearings

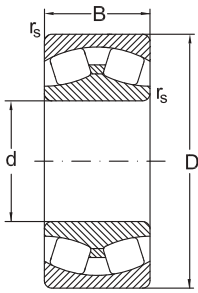

C

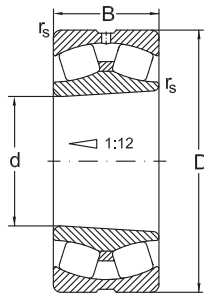

CKW33

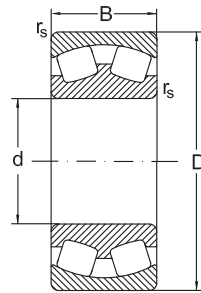

MB

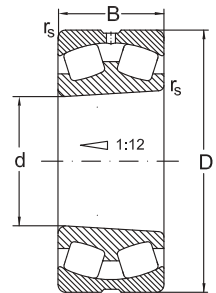

MBKW33

Dimensions				Basic radial load. Factors				
d	D	B	r_s min.	dyn. C_r	e	y_1	y_2	stat. C_{0r}
mm				kN	kN			
100	180	60,3	2,1	495	0,33	2	3	720
	180	60,3	2,1	495	0,33	2	3	720
	180	60,3	2,1	495	0,33	2	3	720
	180	60,3	2,1	495	0,33	2	3	720
	180	60,3	2,1	455	0,33	2	3	660
	180	60,3	2,1	455	0,33	2	3	660
	180	60,3	2,1	455	0,33	2	3	660
	180	60,3	2,1	455	0,33	2	3	660
	180	60,3	2,1	455	0,33	2	3	660
	180	60,3	2,1	455	0,33	2	3	660
	180	60,3	2,1	455	0,33	2	3	660
	215	47	3	460	0,22	3,1	4,7	640
	215	47	3	425	0,22	3,1	4,7	580
	215	47	3	425	0,22	3,1	4,7	580
	215	73	3	730	0,35	1,9	2,9	960
	215	73	3	730	0,35	1,9	2,9	960
	215	73	3	730	0,35	1,9	2,9	960
	215	73	3	730	0,35	1,9	2,9	960
	215	73	3	730	0,35	1,9	2,9	960
	215	73	3	730	0,35	1,9	2,9	960
	215	73	3	670	0,37	1,8	2,9	880
	215	73	3	670	0,37	1,8	2,9	880
	215	73	3	670	0,37	1,8	2,9	880
	215	73	3	670	0,37	1,8	2,9	880
215	73	3	670	0,37	1,8	2,7	880	
215	73	3	670	0,37	1,8	2,7	880	

Spherical Roller Bearings

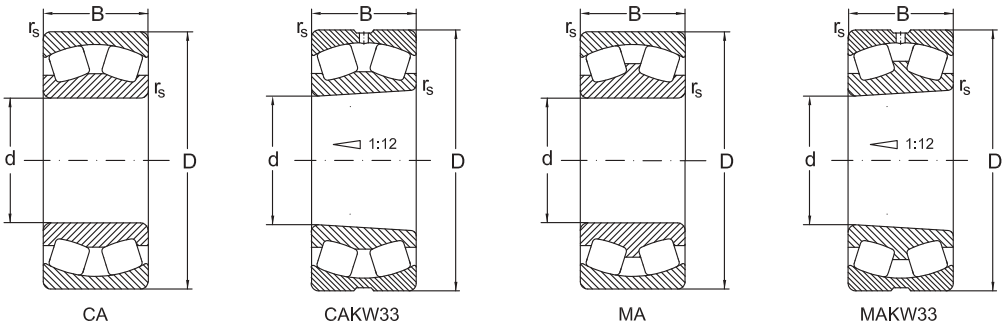

d	y ₀	Speed limit		Designation	Mass
		grease	oil		
mm		min ⁻¹		Bearing	kg
100	2	1700	2200	23220 C	7,34
	2	1700	2200	23220 CK	7,19
	2	1700	2200	23220 CKW33	7,13
	2	1700	2200	23220 CW33	7,28
	2	1500	2000	23220 MA	7,04
	2	1500	2000	23220 MAK	6,85
	2	1500	2000	23220 MAW33	7,03
	2	1500	2000	23220 MAKW33	6,84
	2	1500	2000	23220 MBK	6,8
	2	1500	2000	23220 MB	6,99
	2	1500	2000	23220 MBW33	6,98
	3,1	1800	2400	21320 CA	9,07
	3,1	1700	2200	21320 MB	8,96
	3,1	1700	2200	21320 MBK	8,84
	1,9	1500	2000	22320 C	12,95
	1,9	1500	2000	22320 CK	12,67
	1,9	1500	2000	22320 CW33	12,83
	1,9	1500	2000	22320 CKW33	12,55
	1,9	1500	2000	22320 CYW33	12,83
	1,7	1400	1800	22320 MBK	13,21
	1,7	1400	1800	22320 MBKW33	13,09
	1,7	1400	1800	22320 MA	13,89
	1,7	1400	1800	22320 MAC4F80W33	13,78
	1,7	1400	1800	22320 MB	13,49
1,7	1400	1800	22320 MBW33	13,37	

Spherical Roller Bearings

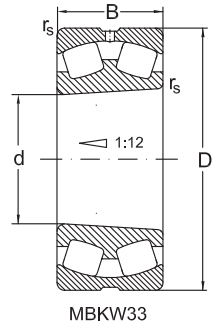
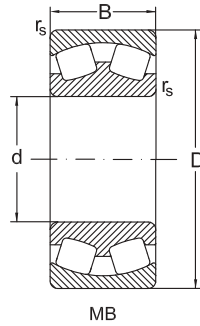
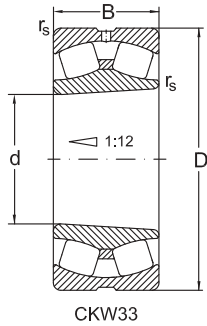
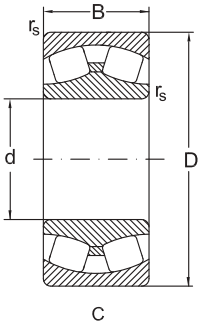

Dimensions				Basic radial load. Factors				
d	D	B	r _s min.	dyn. C _r	e	y ₁	y ₂	stat. C _{0r}
mm				kN	kN			
110	170	45	2	295	0,24	2,8	4,2	485
	170	45	2	295	0,24	2,8	4,2	485
	170	45	2	295	0,24	2,8	4,2	485
	170	45	2	295	0,24	2,8	4,2	485
	180	56	2	450	0,3	2,3	3,4	700
	180	56	2	410	0,3	2,3	3,3	640
	180	56	2	410	0,3	2,3	3,3	640
	180	56	2	410	0,3	2,3	3,3	640
	180	56	2	410	0,3	2,3	3,3	640
	180	69	2	466	0,39	1,7	2,6	771
	180	69	2	466	0,39	1,7	2,6	771
	180	69	2	466	0,39	1,7	2,6	771
	180	69	2	466	0,39	1,7	2,6	771
	200	53	2,1	515	0,25	2,7	4	650
	200	53	2,1	515	0,25	2,7	4	650
	200	53	2,1	515	0,25	2,7	4	650
	200	53	2,1	515	0,25	2,7	4	650
	200	53	2,1	455	0,28	2,4	3,5	585
	200	53	2,1	455	0,28	2,4	3,5	585
	200	53	2,1	455	0,28	2,4	3,5	585
200	53	2,1	455	0,28	2,4	3,5	585	
200	69,8	2,1	620	0,33	2	3	920	
200	69,8	2,1	570	0,37	1,8	2,7	840	
200	69,8	2,1	570	0,37	1,8	2,7	840	
200	69,8	2,1	570	0,37	1,8	2,7	840	

Spherical Roller Bearings

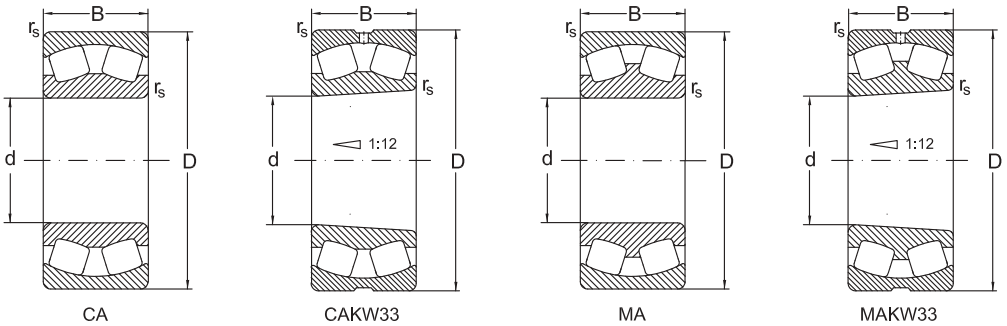

d	y ₀	Speed limit		Designation	Mass
		grease	oil	Bearing	
mm		min ⁻¹			kg
110	2,7	2000	2600	23022 MBK	3,58
	2,7	2000	2600	23022 MBKW33	3,56
	2,7	2000	2600	23022 MB	3,8
	2,7	2000	2600	23022 MBW33	3,56
	2,2	2000	2600	23122 C	6,26
	2,2	1800	2400	23122 MBK	5,18
	2,2	1800	2400	23122 MB	5,29
	2,2	1800	2400	23122 MBW33	5,19
	2,2	1800	2400	23122 MBKW33	5,07
	1,7	1200	1600	24122 CA	6,9
	1,7	1200	1600	24122 CAW33	6,82
	1,7	1200	1600	24122 CAK30	6,8
	1,7	1200	1600	24122 CAK30W33	6,77
	2,5	1800	2400	22222 C	7,52
	2,5	1800	2400	22222 CK	7,45
	2,5	1800	2400	22222 CKW33	7,39
	2,5	1800	2400	22222 CW33	7,45
	2,3	1700	2200	22222 MBK	7,1
	2,3	1700	2200	22222 MB	7,31
	2,3	1700	2200	22222 MBW33	7,1
	2,3	1700	2200	22222 MBKW33	7
	2	1400	1800	23222 C	10,75
	1,8	1200	1600	23222 MBK	9,4
1,8	1200	1600	23222 MB	9,7	
1,8	1200	1600	23222 MBW20	9,5	

Spherical Roller Bearings

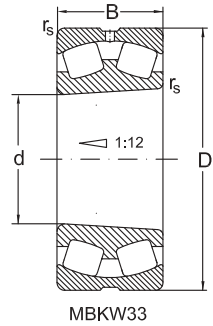
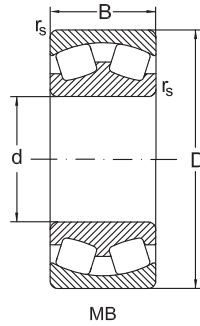
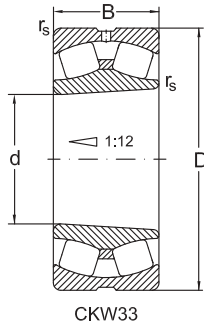
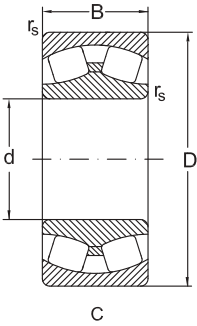

Dimensions				Basic radial load. Factors				
d	D	B	r _s min.	dyn. C _r	e	y ₁	y ₂	stat. C _{0r}
mm				kN	kN			
110	200	69,8	2,1	570	0,37	1,8	2,7	840
	200	69,8	2,1	570	0,37	1,8	2,7	840
	240	50	3	475	0,21	3,2	4,8	500
	240	50	3	475	0,21	3,2	4,8	500
	240	80	3	870	0,34	1,2	2,3	1160
	240	80	3	870	0,34	1,2	2,3	1160
	240	80	3	870	0,34	1,2	2,3	1160
	240	80	3	870	0,34	1,2	2,3	1160
	240	80	3	870	0,34	2	3	1160
	240	80	3	870	0,34	2	3	1160
	240	80	3	800	0,37	1,8	2,7	1060
	240	80	3	800	0,37	1,8	2,7	1060
	240	80	3	800	0,37	1,8	2,7	1060
	240	80	3	800	0,37	1,8	2,7	1060
	240	80	3	800	0,37	1,8	2,7	1060
	120	180	46	2	365	0,22	3	4,6
180		46	2	365	0,22	3	4,6	610
180		46	2	365	0,22	3	4,6	610
180		46	2	365	0,22	3	4,6	610
180		46	2	335	0,24	2,8	4,2	560
180		46	2	335	0,24	2,8	4,2	560
180		46	2	335	0,24	2,8	4,2	560
180		46	2	335	0,24	2,8	4,2	560

Spherical Roller Bearings

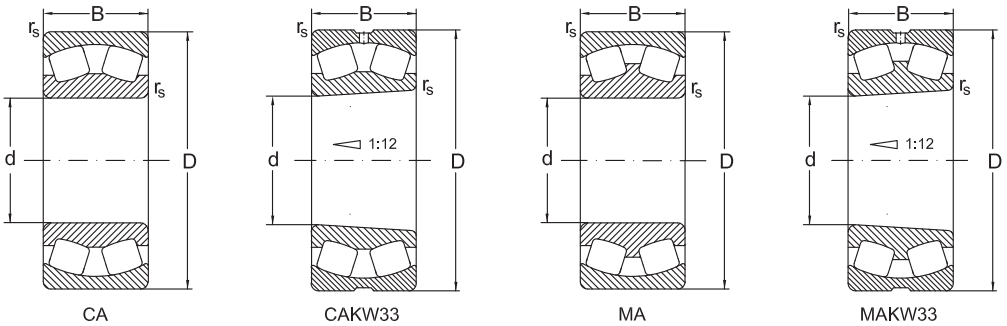

d	y ₀	Speed limit		Designation	Mass
		grease	oil	Bearing	
mm		min ⁻¹			kg
110	1,8	1200	1600	23222 MBW33	9,45
	1,8	1200	1600	23222 MBKW33	9,25
	3,2	1500	2000	21322 MB	12
	3,2	1500	2000	21322 MBK	11,7
	1,2	1400	1900	22322 C	18
	1,2	1400	1900	22322 CW33	17,7
	1,2	1400	1900	22322 CK	17,5
	1,2	1400	1900	22322 CKW33	17,2
	2	1400	1900	22322 CY	18
	2	1400	1900	22322 CYK	18,5
	1,8	1300	1700	22322 MBK	17,2
	1,8	1300	1700	22322 MBKW33	17,9
	1,8	1300	1700	22322 MB	18,7
	1,8	1300	1700	22322 MBW33	18,4
	1,8	1300	1700	22322 MA	18,7
	120	1,8	1300	1700	22322 MAC4F80W33
1,8		1300	1700	22322 MAW33	18,4
2,8		2000	2600	23024 C	4,31
2,8		2000	2600	23024 CK	4,11
2,8		2000	2600	23024 CKW33	4,02
2,8		2000	2600	23024 CW33	4,22
2,8		1800	2400	23024 MBK	4
2,8		1800	2400	23024 MB	4,19
	2,8	1800	2400	23024 MBW33	4,1
	2,8	1800	2400	23024 MBKW33	3,9

Spherical Roller Bearings

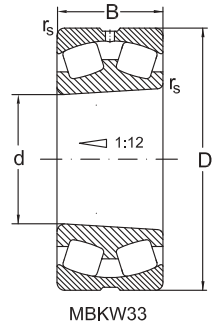
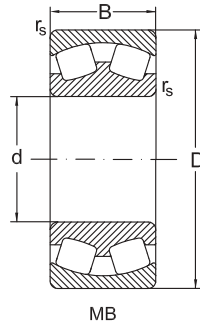
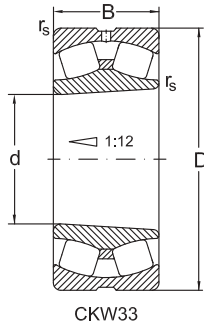
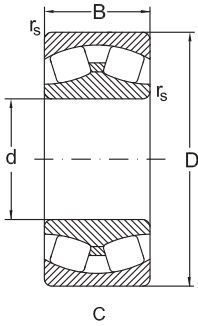

Dimensions				Basic radial load. Factors				
d	D	B	r _s min.	dyn. C _r	e	y ₁	y ₂	stat. C _{0r}
mm				kN				
120	180	60	2	450	0,35	2,3	3,3	800
	180	60	2	450	0,35	2,3	3,3	800
	180	60	2	430	0,32	2,1	3,1	770
	180	60	2	430	0,32	2,1	3,1	770
	180	60	2	410	0,32	2,1	3,1	740
	180	60	2	410	0,32	2,1	3,1	740
	180	60	2	410	0,32	2,1	3,1	740
	200	62	2	510	0,35	2,3	3,5	800
	200	62	2	510	0,35	2,3	3,5	800
	200	62	2	495	0,31	2,2	3,3	770
	200	62	2	495	0,31	2,2	3,3	770
	200	62	2	495	0,31	2,2	3,3	770
	200	62	2	495	0,31	2,2	3,3	770
	200	80	2	630	0,4	1,7	2,5	1050
	200	80	2	630	0,4	1,7	2,5	1050
	200	80	2	630	0,4	1,7	2,5	1050
	215	58	2,1	590	0,27	2,6	3,8	800
	215	58	2,1	590	0,27	2,6	3,8	800
	215	58	2,1	590	0,27	2,6	3,8	800
	215	58	2,1	590	0,27	2,6	3,8	800
	215	58	2,1	540	0,29	2,3	3,5	740
	215	58	2,1	540	0,29	2,3	3,5	740
	215	58	2,1	540	0,29	2,3	3,5	740
	215	58	2,1	540	0,29	2,3	3,5	740
215	76	2,1	730	0,35	1,9	2,9	1120	

Spherical Roller Bearings

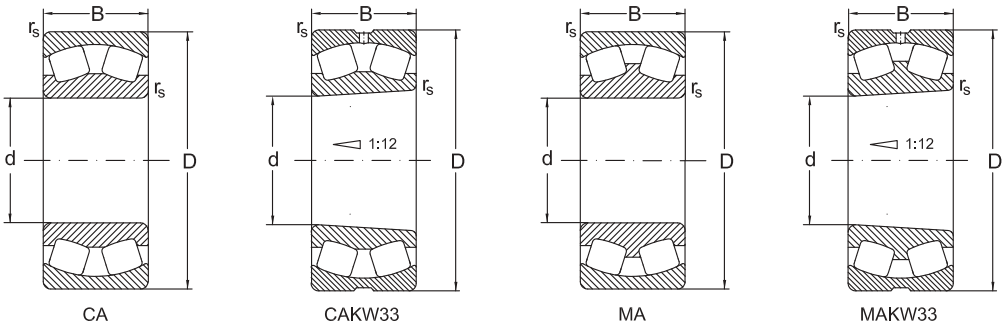

d	y ₀	Speed limit		Designation	Mass
		grease	oil		
mm		min ⁻¹		Bearing	kg
120	2,2	1600	2200	24024 C	5,2
	2,2	1600	2200	24024 CW33	4,9
	2	1500	2000	24024 CAW33	5,4
	2	1500	2000	24024 CAK30W33	5,3
	2	1400	1800	24024 MBK30W33	5,1
	2	1400	1800	24024 MB	5,12
	2	1400	1800	24024 MBW33	5,1
	2,3	1800	2400	23124 C	7,8
	2,3	1800	2400	23124 CW33	7,7
	2,2	1700	2200	23124 MBK	7,9
	2,2	1700	2200	23124 MB	8,19
	2,2	1700	2200	23124 MBW33	8,13
	2,2	1700	2200	23124 MBKW33	7,84
	1,6	1000	1300	24124 MB	10,22
	1,6	1000	1300	24124 MBW33	10,2
	1,6	1000	1300	24124 MBK30W33	10,04
	2,5	1700	2200	22224 C	8,9
	2,5	1700	2200	22224 CK	8,7
	2,5	1700	2200	22224 CW33	8,8
	2,5	1700	2200	22224 CKW33	8,6
	2,3	1500	2000	22224 MBK	9,03
	2,3	1500	2000	22224 MBKW33	9,09
	2,3	1500	2000	22224 MB	9,73
2,3	1500	2000	22224 MBW33	9,53	
1,8	1300	1700	23224 C	13,1	

Spherical Roller Bearings

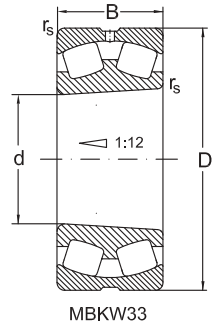
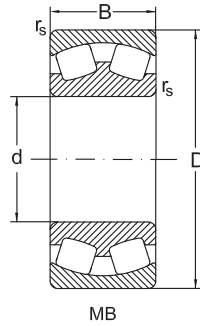
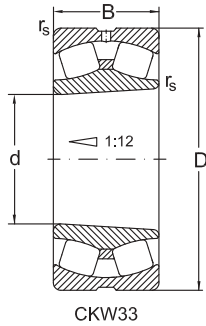
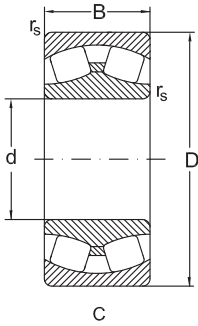

Dimensions				Basic radial load. Factors				
d	D	B	r _s min.	dyn. C _r	e	y ₁	y ₂	stat. C _{0r}
mm				kN	kN			
120	215	76	2,1	670	0,37	1,8	2,7	1020
	215	76	2,1	670	0,37	1,8	2,7	1020
	215	76	2,1	670	0,37	1,8	2,7	1020
	215	76	2,1	670	0,37	1,8	2,7	1020
	260	86	3	1010	0,35	1,9	2,9	1340
	260	86	3	1010	0,35	1,9	2,9	1340
	260	86	3	1010	0,35	1,9	2,9	1340
	260	86	3	1010	0,35	1,9	2,9	1340
	260	86	3	930	0,36	1,8	2,7	1230
	260	86	3	930	0,36	1,8	2,7	1230
	260	86	3	930	0,36	1,8	2,7	1230
	260	86	3	930	0,36	1,8	2,7	1230
	260	86	3	930	0,36	1,8	2,7	1230
	260	86	3	930	0,36	1,8	2,7	1230
130	200	52	2	450	0,27	3	4,6	730
	200	52	2	450	0,27	3	4,6	730
	200	52	2	450	0,27	3	4,6	730
	200	52	2	450	0,27	3	4,6	730
	200	52	2	410	0,23	2,9	4,4	670
	200	52	2	410	0,23	2,9	4,4	670
	200	52	2	410	0,23	2,9	4,4	670
	200	52	2	410	0,23	2,9	4,4	670
	200	69	2	530	0,34	2	3	900
	200	69	2	530	0,34	2	3	900
	200	69	2	530	0,34	2	3	900

Spherical Roller Bearings

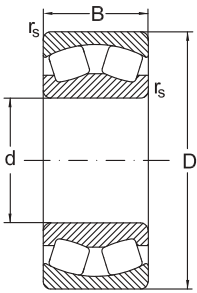

CA

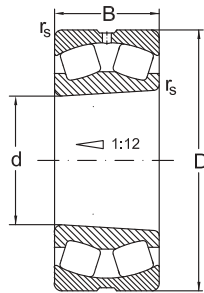

CAKW33

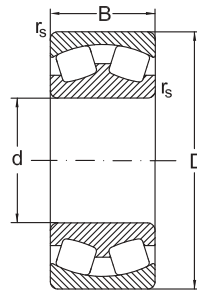

MA

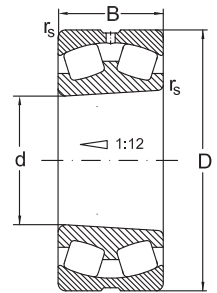

MAKW33

d	y ₀	Speed limit		Designation	Mass
		grease	oil	Bearing	
mm		min ⁻¹			kg
120	1,8	1100	1500	23224 MBK	11,84
	1,8	1100	1500	23224 MB	12,8
	1,8	1100	1500	23224 MBW33	11,73
	1,8	1100	1500	23224 MBKW33	11
	1,8	1300	1700	22324 C	23,76
	1,8	1300	1700	22324 CK	23,29
	1,8	1300	1700	22324 CKW33	23,05
	1,8	1300	1700	22324 CW33	23,52
	1,8	1100	1500	22324 MAK4F80W33	23,4
	1,8	1100	1500	22324 MBK	22,93
	1,8	1100	1500	22324 MAC4F80W33	23,93
	1,8	1100	1500	22324 MB	23,39
	1,8	1100	1500	22324 MBW33	23,18
	1,8	1100	1500	22324 MBKW33	22,71
130	2,9	1800	2400	23026 C	6,09
	2,9	1800	2400	23026 CK	5,7
	2,9	1800	2400	23026 CKW33	5,4
	2,9	1800	2400	23026 CW33	5,8
	2,8	1700	2200	23026 MBK	5,61
	2,8	1700	2200	23026 MB	5,78
	2,8	1700	2200	23026 MBW33	5,73
	2,8	1700	2200	23026 MBKW33	5,56
	1,9	1200	1600	24026 C	
	1,9	1200	1600	24026 CW33	
	1,9	1200	1600	24026 MB	7,98

Spherical Roller Bearings

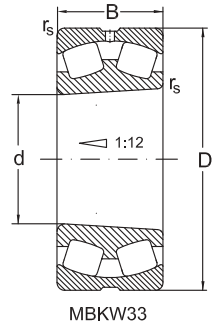
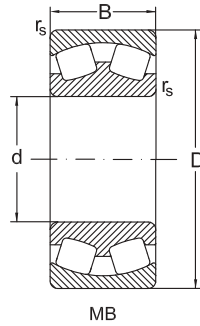
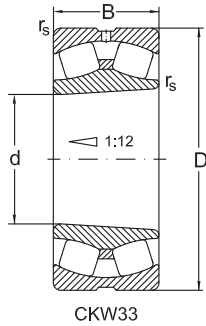
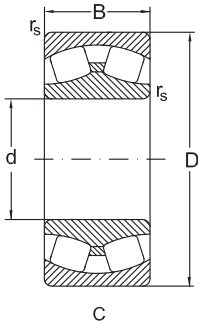

Dimensions				Basic radial load. Factors				
d	D	B	r _s min.	dyn. C _r	e	y ₁	y ₂	stat. C _{0r}
mm				kN	kN			
130	200	69	2	530	0,34	2	3	900
	200	69	2	530	0,34	2	3	900
	210	64	2	590	0,28	2,4	3,6	940
	210	64	2	540	0,3	2,3	3,3	860
	210	64	2	540	0,3	2,3	3,3	860
	210	64	2	540	0,3	2,3	3,3	860
	210	64	2	540	0,3	2,3	3,3	860
	210	80	2	650	0,37	1,8	2,7	1100
	210	80	2	650	0,37	1,8	2,7	1100
	210	80	2	650	0,37	1,8	2,7	1100
	230	64	3	660	0,29	2,3	3,5	960
	230	64	3	660	0,29	2,3	3,5	960
	230	64	3	660	0,29	2,3	3,5	960
	230	64	3	660	0,29	2,3	3,5	960
	230	64	3	660	0,29	2,3	3,5	960
	230	64	3	660	0,29	2,3	3,5	960
	230	64	3	660	0,29	2,3	3,5	960
	230	64	3	600	0,29	2,3	3,4	880
	230	64	3	600	0,29	2,3	3,4	880
	230	64	3	600	0,29	2,3	3,4	880
	230	64	3	600	0,29	2,3	3,4	880
	230	80	3	830	0,33	2	3	1270
	230	80	3	760	0,35	1,9	2,8	1170
	230	80	3	760	0,35	1,9	2,8	1170
230	80	3	760	0,35	1,9	2,8	1170	

Spherical Roller Bearings

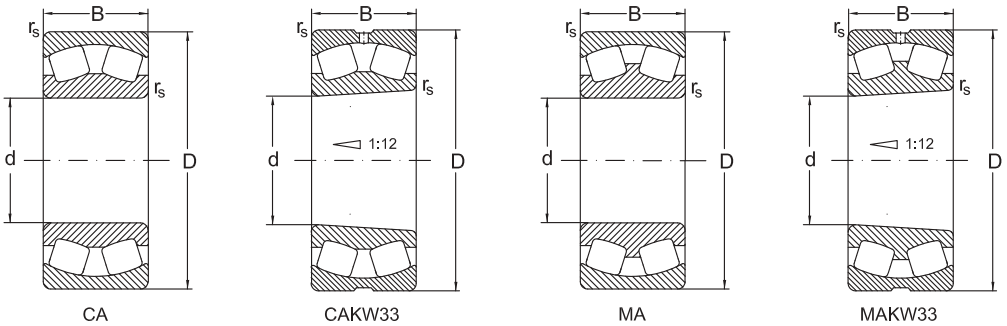

d	y_0	Speed limit		Designation	Mass
		grease	oil	Bearing	
mm		min ⁻¹			kg
130	1,9	1200	1600	24026 MBW33	7,99
	1,9	1200	1600	24026 MBK30W33	7,78
	2,5	1700	2200	23126 C	9,7
	2,2	1500	2000	23126 MBK	8,36
	2,2	1500	2000	23126 MB	8,66
	2,2	1500	2000	23126 MBW33	8,4
	2,2	1500	2000	23126 MBKW33	8,16
	1,8	900	1200	24126 MB	11,4
	1,8	900	1200	24126 MBW33	11,07
	1,8	900	1200	24126 MBK30W33	10,64
	2,3	1700	2200	22226 C	11,14
	2,3	1700	2200	22226 CW33	10,9
	2,3	1700	2200	22226 CK	10,87
	2,3	1700	2200	22226 CKW33	10,6
	2,3	1700	2200	22226 CY	11,14
	2,3	1700	2200	22226 CYK	10,87
	2,3	1700	2200	22226 CYW33	10,9
	2,2	1500	2000	22226 MB	11,47
	2,2	1500	2000	22226 MBKW33	11,2
	2,2	1500	2000	22226 MBW33	11,3
	2,2	1500	2000	22226 MBK	11,35
	2	1300	1700	23226 C	15,86
	1,9	1100	1500	23226 MBK	14,52
1,9	1100	1500	23226 MB	14,97	
1,9	1100	1500	23226 MBW33	14,95	

Spherical Roller Bearings

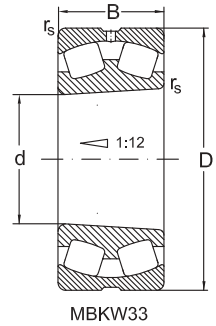
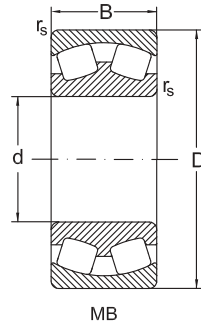
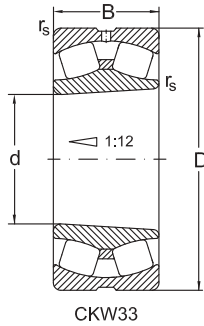
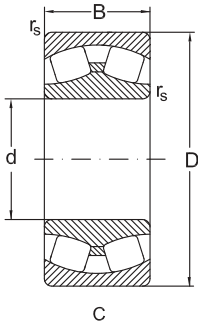

Dimensions				Basic radial load. Factors				
d	D	B	r_s min.	dyn. C_r	e	y_1	y_2	stat. C_{0r}
mm				kN	kN			
130	230	80	3	760	0,35	1,9	2,8	1170
	280	93	4	1170	0,35	1,9	2,9	1580
	280	93	4	1170	0,35	1,9	2,9	1580
	280	93	4	1170	0,35	1,9	2,9	1580
	280	93	4	1170	0,35	1,9	2,9	1580
	280	93	4	1170	0,35	1,9	2,9	1580
	280	93	4	1080	0,37	1,8	2,7	1450
	280	93	4	1080	0,37	1,8	2,7	1450
	280	93	4	1080	0,37	1,8	2,7	1450
	280	93	4	1080	0,37	1,8	2,7	1450
	280	93	4	1080	0,37	1,8	2,7	1450
140	210	53	2	475	0,22	3	4,6	820
	210	53	2	475	0,22	3	4,6	820
	210	53	2	475	0,22	3	4,6	820
	210	53	2	475	0,22	3	4,6	820
	210	53	2	435	0,22	3	4,6	750
	210	53	2	435	0,22	3	4,6	750
	210	53	2	435	0,22	3	4,6	750
	210	53	2	435	0,22	3	4,6	750
	210	69	2	550	0,32	2,1	3,1	990
	210	69	2	550	0,32	2,1	3,1	990
	225	68	2,1	660	0,28	2,4	3,6	1080
	225	68	2,1	600	0,3	2,3	3,3	990
	225	68	2,1	600	0,3	2,3	3,3	990
	225	68	2,1	600	0,3	2,3	3,3	990

Spherical Roller Bearings

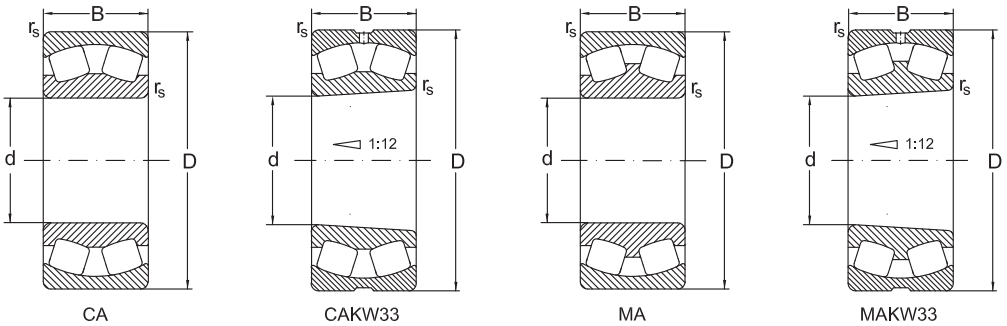

d	y_0	Speed limit		Designation	Mass
		grease	oil	Bearing	
mm		min ⁻¹			kg
130	1,9	1100	1500	23226 MBKW33	14,5
	1,8	1200	1600	22326 C	28,82
	1,8	1200	1600	22326 CK	28,65
	1,8	1200	1600	22326 CKW33	28,33
	1,8	1200	1600	22326 CW33	28,45
	1,8	1200	1600	22326 CYW502	28,45
	1,8	1100	1400	22326 MBK	28,77
	1,8	1100	1400	22326 MAC4F80W33	29,48
	1,8	1100	1400	22326 MB	28,9
	1,8	1100	1400	22326 MBW33	28,7
	1,8	1100	1400	22326 MBKW33	28,4
140	2,8	1700	2200	23028 C	7,20
	2,8	1700	2200	23028 CK	7,03
	2,8	1700	2200	23028 CKW33	6,96
	2,8	1700	2200	23028 CW33	7,13
	2,8	1500	2000	23028 MBK	6,07
	2,8	1500	2000	23028 MB	6,18
	2,8	1500	2000	23028 MBW33	6,08
	2,8	1500	2000	23028 MBKW33	5,98
	2,1	1100	1500	24028 MBW33	9,07
	2,1	1100	1500	24028 MBK30W33	8,66
	2,5	1500	2000	23128 C	11,8
	2,2	1400	1800	23128 MBK	10,38
	2,2	1400	1800	23128 MB	10,72
2,2	1400	1800	23128 MBW33	10,69	

Spherical Roller Bearings

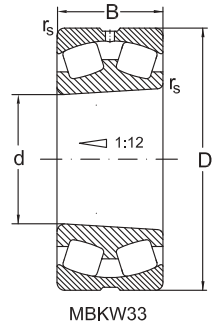
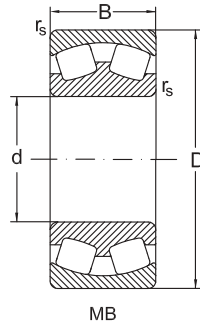
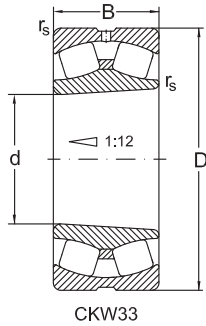
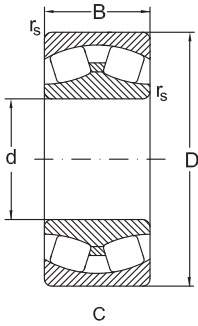

Dimensions				Basic radial load. Factors				
d	D	B	r_s min.	dyn. C_r	e	y_1	y_2	stat. C_{0r}
mm				kN				
140	225	68	2,1	600	0,3	2,3	3,3	990
	225	85	2,1	740	0,37	1,8	2,7	1280
	225	85	2,1	740	0,37	1,8	2,7	1280
	225	85	2,1	740	0,37	1,8	2,7	1280
	250	68	3	730	0,26	2,6	3,9	1080
	250	68	3	730	0,26	2,6	3,9	1080
	250	68	3	730	0,26	2,6	3,5	1080
	250	68	3	730	0,26	2,6	3,9	1080
	250	68	3	670	0,29	2,3	3,5	990
	250	68	3	670	0,29	2,3	3,5	990
	250	68	3	670	0,29	2,3	3,5	990
	250	68	3	670	0,29	2,3	3,5	990
	250	88	3	960	0,33	2	3	1500
	250	88	3	880	0,37	1,8	2,7	1380
	250	88	3	880	0,37	1,8	2,7	1380
	250	88	3	880	0,37	1,8	2,7	1380
	250	88	3	880	0,37	1,8	2,7	1380
	300	102	4	1360	0,35	1,9	2,9	1870
	300	102	4	1360	0,35	1,9	2,9	1870
	300	102	4	1360	0,35	1,9	2,9	1870
	300	102	4	1240	0,38	1,7	2,6	1720
	300	102	4	1240	0,38	1,7	2,6	1720
	300	102	4	1240	0,38	1,7	2,6	1720
	300	102	4	1240	0,38	1,7	2,6	1720

Spherical Roller Bearings

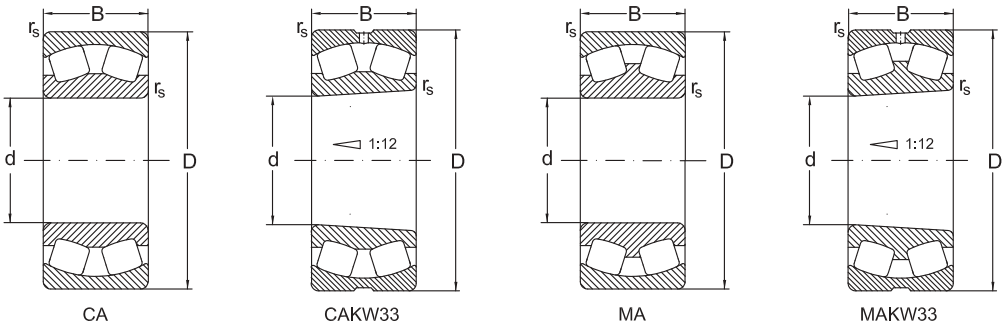

d	y_0	Speed limit		Designation	Mass
		grease	oil	Bearing	
mm		min ⁻¹			kg
140	2,2	1400	1800	23128 MBKW33	10,36
	1,8	850	1100	24128 MB	13,27
	1,8	850	1100	24128 MBW33	13,2
	1,8	850	1100	24128 MBK30W33	12,64
	2,5	1400	1900	22228 C	14,4
	2,5	1400	1900	22228 CK	14,09
	2,5	1400	1900	22228 CKW33	13,97
	2,5	1400	1900	22228 CW33	14,27
	2,3	1300	1700	22228 MBK	14,2
	2,3	1300	1700	22228 MB	14,5
	2,3	1300	1700	22228 MBW33	14,27
	2,3	1300	1700	22228 MBKW33	13,97
	2	1100	1400	23228 C	20,86
	1,8	1000	1300	23228 MBK	18,72
	1,8	1000	1300	23228 MB	19,32
	1,8	1000	1300	23228 MBW33	19,19
	1,8	1000	1300	23228 MBKW33	18,59
	1,8	1100	1400	22328 C	36,9
	1,8	1100	1400	22328 CK	36,34
	1,8	1100	1400	22328 CKW33	36,13
	1,8	1100	1400	22328 CW33	36,79
	1,7	1000	1300	22328 MBK	34,57
	1,7	1000	1300	22328 MAC4F80W33	37,5
	1,7	1000	1300	22328 MB	35,77
1,7	1000	1300	22328 MBW33	35,17	

Spherical Roller Bearings

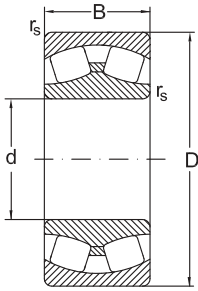

C

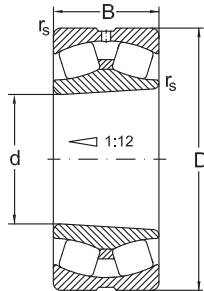

CKW33

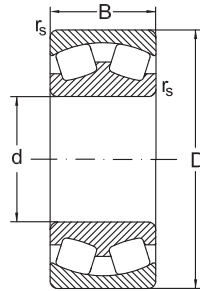

MB

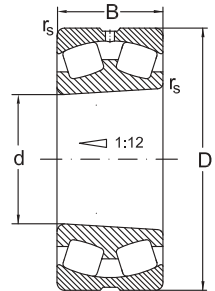

MBKW33

Dimensions				Basic radial load. Factors				
d	D	B	r_s min.	dyn. C_r	e	y_1	y_2	stat. C_{0r}
mm				kN	kN			
140	300	102	4	1240	0,38	1,7	2,6	1720
	300	118	4	1200	0,43	1,6	2,3	1700
150	225	56	2,1	520	0,22	3	4,6	900
	225	56	2,1	520	0,22	3	4,6	900
	225	56	2,1	520	0,22	3	4,6	900
	225	56	2,1	520	0,22	3	4,6	900
	225	56	2,1	480	0,22	3	4,6	830
	225	56	2,1	480	0,22	3	4,6	830
	225	56	2,1	480	0,22	3	4,6	830
	225	56	2,1	480	0,22	3	4,6	830
	225	75	2,1	620	0,37	1,8	2,7	1140
	225	75	2,1	600	0,33	2,1	3,1	1080
	225	75	2,1	600	0,33	2,1	3,1	1080
	225	75	2,1	600	0,33	2,1	3,1	1080
	225	75	2,1	600	0,33	2,1	3,1	1080
	250	100	2,1	1080	0,37	1,8	2,7	1840
	250	100	2,1	990	0,4	1,7	2,5	1600
	250	100	2,1	990	0,4	1,7	2,5	1600
	250	100	2,1	990	0,4	1,7	2,5	1600
	250	100	2,1	990	0,4	1,7	2,5	1600
	250	100	2,1	818	0,4	2,1	2,5	1357
	250	80	2,1	800	0,32	2,1	3,2	1320
250	80	2,1	800	0,32	2,1	3,2	1320	
250	80	2,1	800	0,32	2,1	3,2	1320	
250	80	2,1	800	0,32	2,1	3,2	1320	

Spherical Roller Bearings

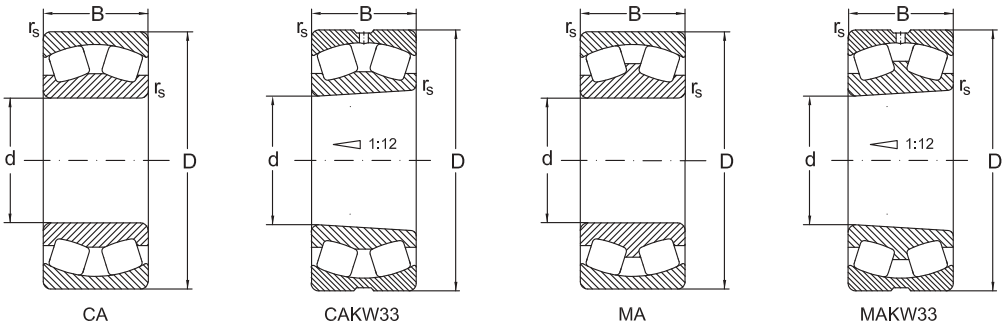

d	y ₀	Speed limit		Designation	Mass
		grease	oil		
mm		min ⁻¹		Bearing	kg
140	1,7	1000	1300	22328 MBKW33	34,37
	1,5	1100	1500	23328 MAC4F80W33	42,23
150	2,8	1500	2000	23030 C	8,57
	2,8	1500	2000	23030 CK	8,4
	2,8	1500	2000	23030 CKW33	8,32
	2,8	1500	2000	23030 CW33	8,51
	2,8	1400	1800	23030 MBK	8,05
	2,8	1400	1800	23030 MB	8,15
	2,8	1400	1800	23030 MBW33	8,11
	2,8	1400	1800	23030 MBKW33	7,9
	2,1	1200	1600	24030 C	10,5
	2	1100	1400	24030 MBK30	10,1
	2	1100	1400	24030 MB	10,25
	2	1100	1400	24030 MBW33	10,14
	2	1100	1400	24030 MBK30W33	9,97
	1,8	850	1100	24130 C	19,4
	1,6	800	1000	24130 CA	19,66
	1,6	800	1000	24130 CAK30	18,9
	1,6	800	1000	24130 CAW33	19,5
	1,6	800	1000	24130 CAK30W33	18,76
1,6	800	1000	24130 MBW33	19,97	
2,1	1300	1700	23130 MBK	16	
2,1	1300	1700	23130 MB	16,37	
2,1	1300	1700	23130 MBW33	16,24	
2,1	1300	1700	23130 MBKW33	16	

Spherical Roller Bearings

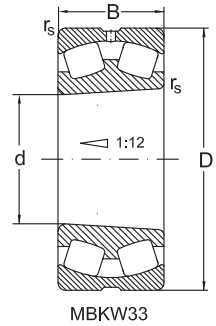
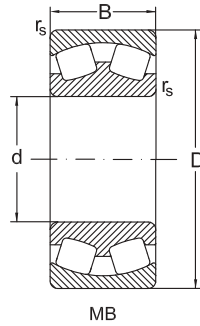
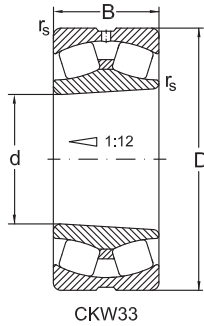
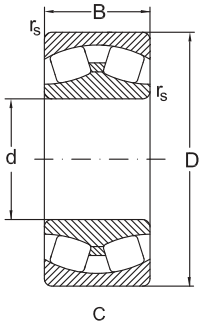

Dimensions				Basic radial load. Factors				
d	D	B	r _s min.	dyn. C _r	e	y ₁	y ₂	stat. C _{0r}
mm				kN	kN			
150	270	73	3	880	0,26	2,6	3,9	1300
	270	73	3	880	0,26	2,6	3,9	1300
	270	73	3	880	0,26	2,6	3,9	1300
	270	73	3	880	0,26	2,6	3,9	1300
	270	73	3	810	0,29	2,3	3,5	1190
	270	73	3	810	0,29	2,3	3,5	1190
	270	73	3	810	0,29	2,3	3,5	1190
	270	73	3	810	0,29	2,3	3,5	1190
	270	96	3	1090	0,4	2,1	2,5	1750
	270	96	3	1030	0,38	1,8	2,7	1610
	270	96	3	1030	0,38	1,8	2,7	1610
	270	96	3	1030	0,38	1,8	2,7	1610
	270	96	3	1030	0,38	1,8	2,7	1610
	320	108	4	1520	0,35	1,9	2,9	2110
	320	108	4	1520	0,35	1,9	2,9	2110
	320	108	4	1520	0,35	1,9	2,9	2110
	320	108	4	1520	0,35	1,9	2,9	2110
	320	108	4	1400	0,38	1,7	2,6	1940
	320	108	4	1400	0,38	1,7	2,6	1940
	320	108	4	1400	0,38	1,7	2,6	1940
320	108	4	1400	0,38	1,7	2,6	1940	
320	108	4	1400	0,38	1,7	2,6	1940	
320	108	4	1400	0,38	1,7	2,6	1940	
320	108	4	1400	0,38	1,7	2,6	1940	
160	240	60	2,1	610	0,22	3	4,6	1060
	240	60	2,1	610	0,22	3	4,6	1060

Spherical Roller Bearings

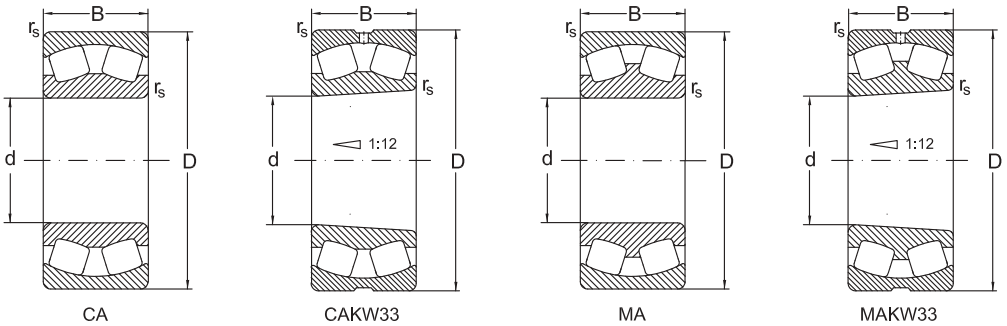

d	y ₀	Speed limit		Designation	Mass
		grease	oil		
mm		min ⁻¹		Bearing	kg
150	2,5	1400	1800	22230 C	18,30
	2,5	1400	1800	22230 CK	18,23
	2,5	1400	1800	22230 CKW33	16,99
	2,5	1400	1800	22230 CW33	18,07
	2,3	1200	1600	22230 MBK	17,6
	2,3	1200	1600	22230 MB	18,24
	2,3	1200	1600	22230 MBW33	18,02
	2,3	1200	1600	22230 MBKW33	17,62
	1,8	1100	1400	23230 C	24,7
	1,7	1000	1300	23230 MBK	24,13
	1,7	1000	1300	23230 MB	24,7
	1,7	1000	1300	23230 MBW33	24,58
	1,7	1000	1300	23230 MBKW33	24,0
	1,8	1100	1400	22330 C	44,62
	1,8	1100	1400	22330 CK	43,87
	1,8	1100	1400	22330 CKW33	43,47
	1,8	1100	1400	22330 CW33	44,6
	1,7	1000	1300	22330 MAKAC4F80W33	44,3
	1,7	1000	1300	22330 MBK	41,35
	1,7	1000	1300	22330 MAC4F80W33	44,4
1,7	1000	1300	22330 MB	42,25	
1,7	1000	1300	22330 MBW33	41,85	
1,7	1000	1300	22330 MBKW33	40,95	
160	2,8	1400	1900	23032 C	9,97
	2,8	1400	1900	23032 CK	9,71

Spherical Roller Bearings

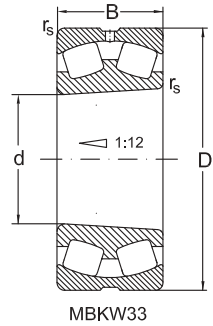
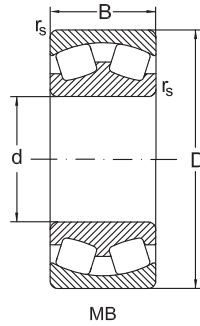
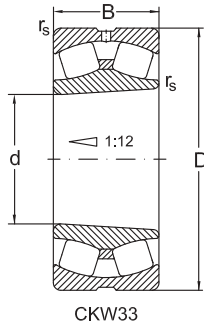
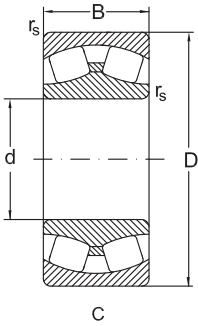

Dimensions				Basic radial load. Factors				
d	D	B	r _s min.	dyn. C _r	e	y ₁	y ₂	stat. C _{0r}
mm				kN	kN			
160	240	60	2,1	610	0,22	3	4,6	1060
	240	60	2,1	610	0,22	3	4,6	1060
	240	60	2,1	560	0,22	3	4,6	970
	240	60	2,1	560	0,22	3	4,6	970
	240	60	2,1	560	0,22	3	4,6	970
	240	60	2,1	560	0,22	3	4,6	970
	240	80	2,1	720	0,38	1,7	2,6	1320
	240	80	2,1	650	0,32	2,1	3,1	1170
	240	80	2,1	650	0,32	2,1	3,1	1170
	240	80	2,1	650	0,32	2,1	3,1	1170
	270	109	2,1	1250	0,39	1,7	2,5	2110
	270	109	2,1	1250	0,39	1,7	2,5	2110
	270	109	2,1	1250	0,39	1,7	2,5	2110
	270	109	2,1	1250	0,39	1,7	2,5	2110
	270	109	2,1	1250	0,39	1,7	2,5	2110
	270	109	2,1	940	0,41	1,6	2,4	1558
	270	86	2,1	1010	0,3	2,3	3,4	1640
	270	86	2,1	930	0,32	2,1	3,2	1510
	270	86	2,1	930	0,32	2,1	3,2	1510
	270	86	2,1	930	0,32	2,1	3,2	1510
	270	86	2,1	930	0,32	2,1	3,2	1510
	290	104	3	1210	0,3	2,3	3,4	1900
	290	104	3	1180	0,38	1,8	2,7	1830
	290	104	3	1180	0,38	1,8	2,7	1830

Spherical Roller Bearings

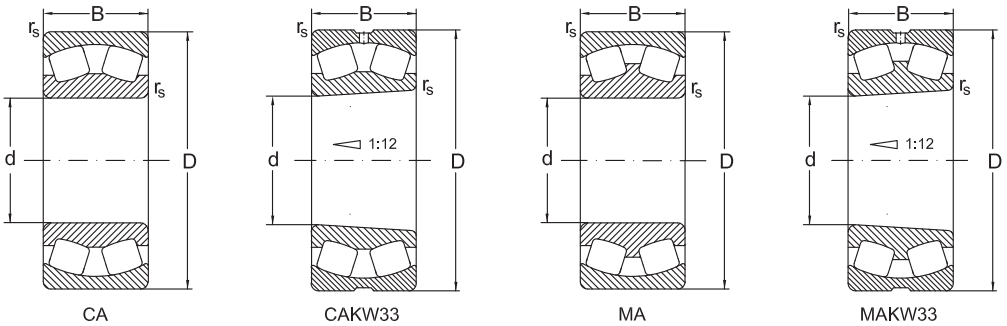

d	y ₀	Speed limit		Designation	Mass
		grease	oil	Bearing	
mm		min ⁻¹			kg
160	2,8	1400	1900	23032 CKW33	9,56
	2,8	1400	1900	23032 CW33	9,80
	2,8	1300	1700	23032 MBK	10,45
	2,8	1300	1700	23032 MB	10,61
	2,8	1300	1700	23032 MBW33	10,49
	2,8	1300	1700	23032 MBKW33	10,33
	2,1	1100	1400	24032 C	13
	2	1000	1300	24032 MB	12,7
	2	1000	1300	24032 MBW33	12,28
	2	1000	1300	24032 MBK30W33	12,08
	1,6	850	1100	24132 C	25,04
	1,6	850	1100	24132 CW33	24,96
	1,6	850	1100	24132 CK30	24,8
	1,6	850	1100	24132 CK30W33	24,6
	1,6	850	1100	24132 CYK30W33	24,6
	1,6	850	1100	24132 CYW33	24,96
	1,6	750	1100	24132 MBW33	25,38
	2,2	1400	1800	23132 C	22,9
	2,1	1200	1600	23132 MBK	20,7
	2,1	1200	1600	23132 MB	20,95
	2,1	1200	1600	23132 MBW33	20,81
	2,1	1200	1600	23132 MBKW33	20,1
	2,2	1000	1400	23232 C	32,7
	1,7	900	1200	23232 MBK	31,7
1,7	900	1200	23232 MB	32,4	

Spherical Roller Bearings

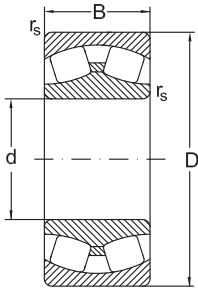

C

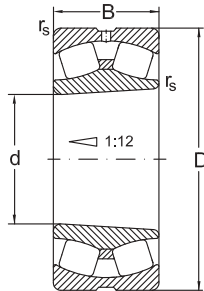

CKW33

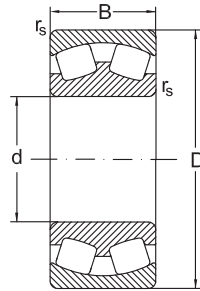

MB

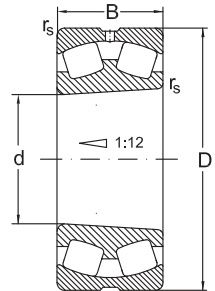

MBKW33

Dimensions				Basic radial load. Factors				
d	D	B	r_s min.	dyn. C_r	e	y_1	y_2	stat. C_{0r}
mm				kN	kN			
160	290	104	3	1180	0,38	1,8	2,7	1830
	290	104	3	1180	0,38	1,8	2,7	1830
	290	80	3	1040	0,26	2,6	3,9	1550
	290	80	3	1040	0,26	2,6	3,9	1550
	290	80	3	1040	0,26	2,6	3,9	1550
	290	80	3	1040	0,26	2,6	3,9	1550
	290	80	3	950	0,29	2,3	3,4	1420
	290	80	3	950	0,29	2,3	3,4	1420
	290	80	3	950	0,29	2,3	3,4	1420
	290	80	3	950	0,29	2,3	3,4	1420
	340	114	4	1660	0,35	1,9	2,9	2350
	340	114	4	1660	0,35	1,9	2,9	2350
	340	114	4	1660	0,35	1,9	2,9	2350
	340	114	4	1660	0,35	1,9	2,9	2350
	340	114	4	1520	0,37	1,8	2,7	2160
	340	114	4	1520	0,37	1,8	2,7	2160
	340	114	4	1520	0,37	1,8	2,7	2160
	340	114	4	1520	0,37	1,8	2,7	2160
	340	114	4	1520	0,37	1,8	2,7	2160
	340	114	4	1520	0,37	1,8	2,7	2160
	340	114	4	1520	0,37	1,8	2,7	2160
	340	114	4	1520	0,37	1,8	2,7	2160
	340	136	4	1540	0,44	1,5	2,3	2200
	170	260	67	2,1	750	0,23	2,9	4,4
260		67	2,1	750	0,23	2,9	4,4	1270

Spherical Roller Bearings

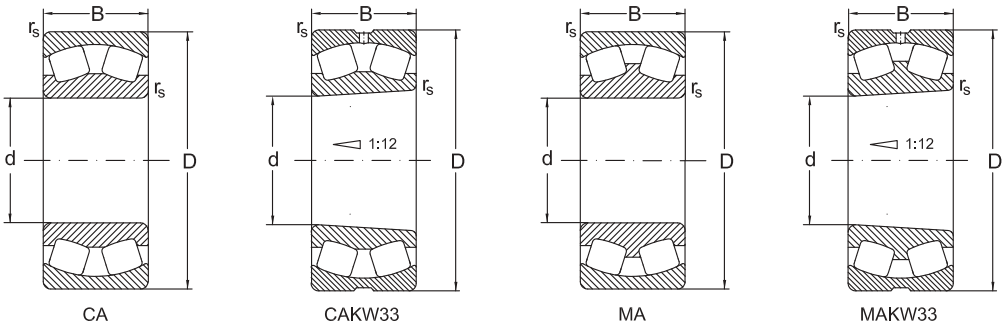

d	y ₀	Speed limit		Designation	Mass
		grease	oil	Bearing	
mm		min ⁻¹			kg
160	1,7	900	1200	23232 MBW33	32,1
	1,7	900	1200	23232 MBKW33	31,2
	2,5	1300	1700	22232 C	25,1
	2,5	1300	1700	22232 CK	24,7
	2,5	1300	1700	22232 CKW33	24,6
	2,5	1300	1700	22232 CW33	24,85
	2,3	1100	1500	22232 MBK	22,27
	2,3	1100	1500	22232 MB	23,3
	2,3	1100	1500	22232 MBW33	22,53
	2,3	1100	1500	22232 MBKW33	22,03
	1,8	1000	1300	22332 C	52,5
	1,8	1000	1300	22332 CK	52,16
	1,8	1000	1300	22332 CKW33	51,74
	1,8	1000	1300	22332 CW33	52,7
	1,8	900	1200	22332 MBK	49,16
	1,8	900	1200	22332 MAC4F80W33	50,08
	1,8	900	1200	22332 MAC4W502	50,0
	1,8	900	1200	22332 MAW33	50,08
	1,8	900	1200	22332 MAW502	50,0
	1,8	900	1200	22332 MB	50,26
1,8	900	1200	22332 MBW33	49,84	
1,8	900	1200	22332 MBKW33	48,74	
1,5	1000	1400	23332 MAC4F80W33	61,85	
170	2,8	1400	1800	23034 C	14,23
	2,8	1400	1800	23034 CK	13,95

Spherical Roller Bearings

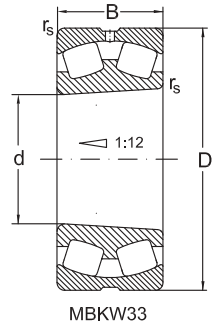
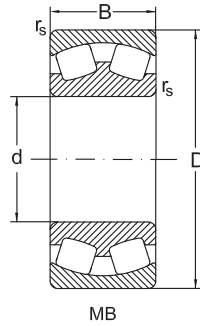
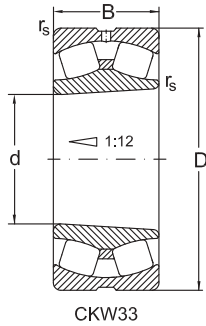
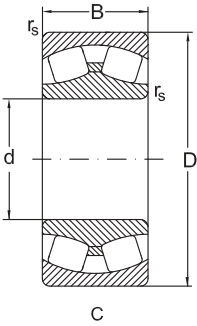

Dimensions				Basic radial load. Factors				
d	D	B	r _s min.	dyn. C _r	e	y ₁	y ₂	stat. C _{0r}
mm				kN	kN			
170	260	67	2,1	750	0,23	2,9	4,4	1270
	260	67	2,1	750	0,23	2,9	4,4	1270
	260	67	2,1	680	0,23	2,9	4,4	1170
	260	67	2,1	680	0,23	2,9	4,4	1170
	260	67	2,1	680	0,23	2,9	4,4	1170
	260	67	2,1	680	0,23	2,9	4,4	1170
	260	90	2,1	880	0,34	2	3	1610
	260	90	2,1	880	0,34	2	3	1610
	260	90	2,1	880	0,34	2	3	1610
	260	90	2,1	880	0,34	2	3	1610
	280	109	2,1	1310	0,37	1,8	2,7	2300
	280	109	2,1	1280	0,39	1,7	2,6	2230
	280	109	2,1	1280	0,39	1,7	2,6	2230
	280	109	2,1	1280	0,39	1,7	2,6	2230
	280	109	2,1	1280	0,39	1,7	2,6	2230
	280	109	2,1	1029	0,37	1,8	2,7	1672
	280	109	2,1	1029	0,37	1,8	2,7	1672
	280	88	2,1	1280	0,37	1,8	2,7	2230
	280	88	2,1	990	0,31	2,2	3,2	1650
	280	88	2,1	990	0,31	2,2	3,2	1650
	280	88	2,1	990	0,31	2,2	3,2	1650
	280	88	2,1	990	0,31	2,2	3,2	1650
	310	110	4	1460	0,35	1,9	2,9	2320
	310	110	4	1460	0,35	1,9	2,9	2320
310	110	4	1460	0,35	1,9	2,9	2320	

Spherical Roller Bearings

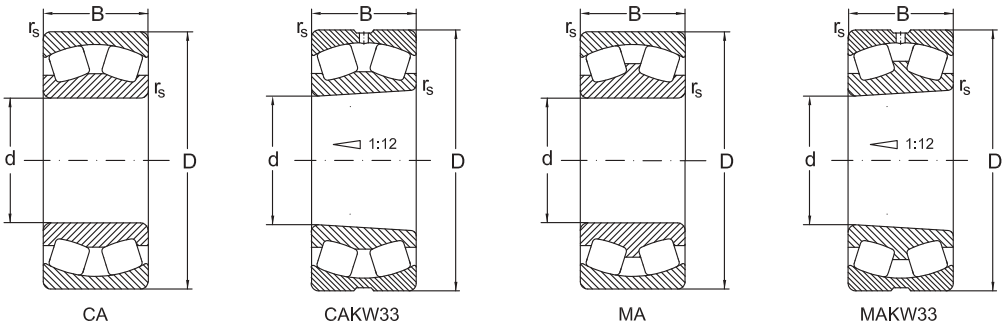

d	y ₀	Speed limit		Designation	Mass
		grease	oil		
mm		min ⁻¹		Bearing	kg
170	2,8	1400	1800	23034 CKW33	13,78
	2,8	1400	1800	23034 CW33	14,2
	2,8	1200	1600	23034 MBK	14,3
	2,8	1200	1600	23034 MB	14,5
	2,8	1200	1600	23034 MBW33	14,18
	2,8	1200	1600	23034 MBKW33	14,08
	2	1000	1300	24034 MBK30	17,3
	2	1000	1300	24034 MB	17,57
	2	1000	1300	24034 MBW33	16,88
	2	1000	1300	24034 MBK30W33	16,65
	1,8	850	1100	24134 C	27,3
	1,7	750	1000	24134 CA	27,7
	1,7	750	1000	24134 CAW33	27,47
	1,7	750	1000	24134 CAK30	27,41
	1,7	750	1000	24134 CAK30W33	27,3
	1,8	650	800	24134 MBK30W33	27,94
	1,8	650	800	24134 MBW33	28,4
	1,8	1300	1700	23134 C	27,3
	2,1	1100	1500	23134 MBK	21,46
	2,1	1100	1500	23134 MB	21,65
	2,1	1100	1500	23134 MBW33	21,5
	2,1	1100	1500	23134 MBKW33	21,2
	1,8	900	1200	23234 CA	37,25
1,8	900	1200	23234 CAK	36,25	
1,8	900	1200	23234 CAKW33	36,1	

Spherical Roller Bearings

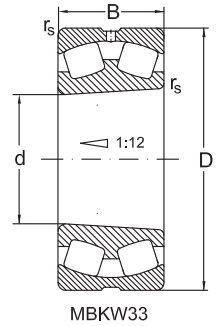
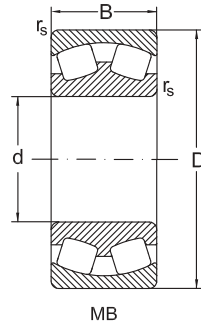
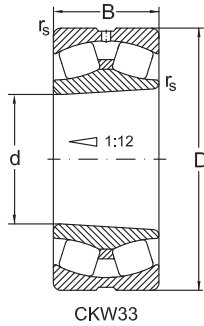
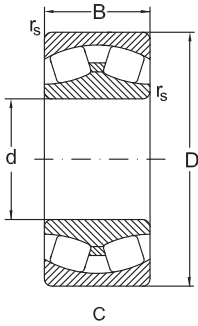

Dimensions				Basic radial load. Factors				
d	D	B	r_s min.	dyn. C_r	e	y_1	y_2	stat. C_{0r}
mm				kN	kN			
170	310	110	4	1460	0,35	1,9	2,9	2320
	310	110	4	1500	0,35	1,9	2,9	2350
	310	110	4	1500	0,35	1,9	2,9	2350
	310	110	4	1500	0,35	1,9	2,9	2350
	310	110	4	1500	0,35	1,9	2,9	2350
	310	110	4	1340	0,36	1,9	2,8	2120
	310	110	4	1340	0,36	1,9	2,8	2120
	310	86	4	1170	0,27	2,5	3,7	1750
	310	86	4	1170	0,27	2,5	3,7	1750
	310	86	4	1170	0,27	2,5	3,7	1750
	310	86	4	1170	0,27	2,5	3,7	1750
	310	86	4	1080	0,3	2,3	3,4	1610
	310	86	4	1080	0,3	2,3	3,4	1610
	310	86	4	1080	0,3	2,3	3,4	1610
	310	86	4	1080	0,3	2,3	3,4	1610
	360	120	4	1850	0,33	2	3	2590
	360	120	4	1850	0,33	2	3	2590
	360	120	4	1850	0,33	2	3	2590
	360	120	4	1690	0,37	1,8	2,7	2380
	360	120	4	1690	0,37	1,8	2,7	2380
360	120	4	1690	0,37	1,8	2,7	2380	
360	120	4	1690	0,37	1,8	2,7	2380	
180	250	52	2	454	0,2	3,5	5,2	830

Spherical Roller Bearings

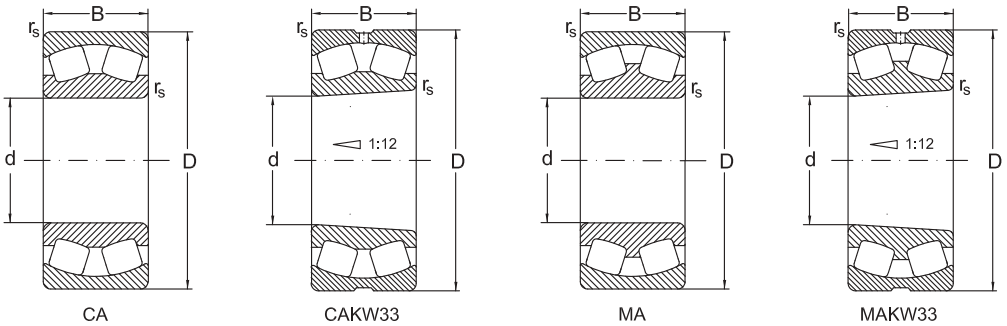

d	y ₀	Speed limit		Designation	Mass
		grease	oil		
mm		min ⁻¹		Bearing	kg
170	1,8	900	1200	23234 CAW33	37,17
	1,8	950	1250	23234 C	35,82
	1,8	950	1250	23234 CK	34,75
	1,8	950	1250	23234 CKW33	34,55
	1,8	950	1250	23234 CW33	35,67
	1,8	850	1100	23234 MBW33	35,9
	1,8	850	1100	23234 MBKW33	35,72
	2,5	1200	1600	22234 C	32,2
	2,5	1200	1600	22234 CK	32
	2,5	1200	1600	22234 CKW33	31,66
	2,5	1200	1600	22234 CW33	31,8
	2,2	1300	1100	22234 MBK	29
	2,2	1100	1400	22234 MB	29,4
	2,2	1100	1400	22234 MBW33	29,15
	2,2	1100	1400	22234 MBKW33	27,51
	2	900	1200	22334 C	65,3
	2	900	1200	22334 CK	64
	2	900	1200	22334 CKW33	63,6
	2	900	1200	22334 CW33	64,9
	1,8	850	1100	22334 MBK	57,53
1,8	850	1100	22334 MAC4F80W33	59	
1,8	850	1100	22334 MB	58,83	
1,8	850	1100	22334 MBW33	58,41	
1,8	850	1100	22334 MBKW33	56,7	
180	3,4	1300	1700	23936 MBW33	7,72

Spherical Roller Bearings

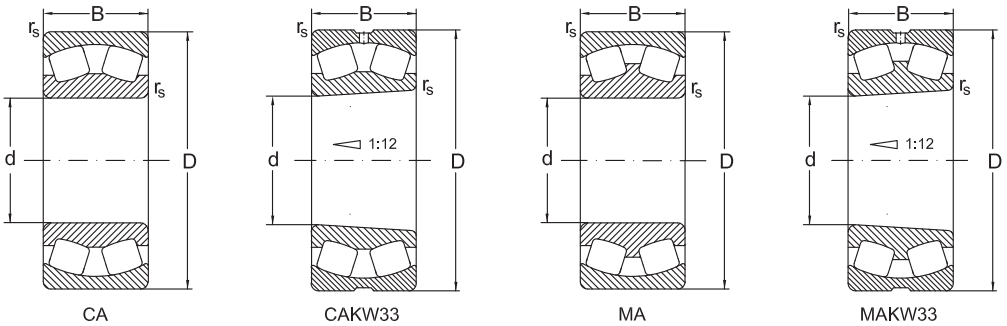

d	y ₀	Speed limit		Designation	Mass
		grease	oil		
mm		min ⁻¹		Bearing	kg
180	1,8	1000	1300	24036 C	23
	1,9	900	1200	24036 MB	22,9
	1,9	900	1200	24036 MBW33	22,79
	1,9	900	1200	24036 MBK30W33	22,42
	2,8	1300	1700	23036 C	18,76
	2,8	1300	1700	23036 CK	18,36
	2,8	1300	1700	23036 CKW33	18,13
	2,8	1300	1700	23036 CW33	18,53
	2,8	1100	1500	23036 MBK	17,2
	2,8	1100	1500	23036 MB	17,7
	2,8	1100	1500	23036 MBW33	17,03
	2,8	1100	1500	23036 MBKW33	16,5
	1,6	600	750	24136 MBK30W33	33,32
	1,9	650	900	24136 CAK30W33	33,42
	1,9	650	900	24136 CAW33	33,96
	1,6	700	950	24136 C	33,52
	1,6	700	950	24136 CW33	33,42
	1,6	700	950	24136 CK30	33,32
	1,6	700	950	24136 CK30W33	33,2
	1,6	700	950	24136 CYW33	33,42
	2,2	1200	1600	23136 C	30,6
2,2	1200	1600	23136 CKW33	29,38	
2,2	1200	1600	23136 CW33	30,25	
2,1	1100	1400	23136 MBK	28	
2,1	1100	1400	23136 MB	28,4	

Spherical Roller Bearings

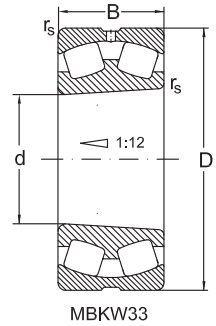
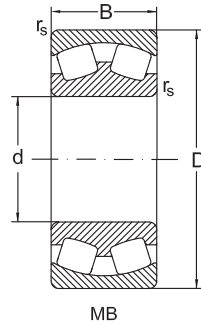
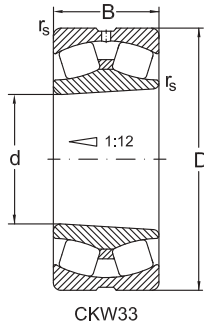
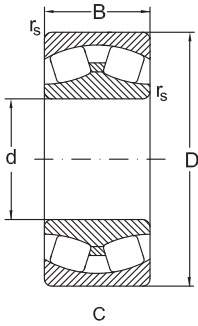

Dimensions				Basic radial load. Factors				
d	D	B	r_s min.	dyn. C_r	e	y_1	y_2	stat. C_{0r}
mm				kN	kN			
180	300	96	3	1160	0,32	2,1	3,1	1940
	300	96	3	1160	0,32	2,1	3,1	1940
	320	112	4	1420	0,36	1,9	2,8	2330
	320	112	4	1420	0,36	1,9	2,8	2330
	320	112	4	1420	0,36	1,9	2,8	2330
	320	86	4	1210	0,26	2,6	3,9	1870
	320	86	4	1210	0,26	2,6	3,9	1870
	320	86	4	1210	0,26	2,6	3,9	1870
	320	86	4	1210	0,26	2,6	3,9	1870
	320	86	4	1110	0,29	2,3	3,5	1720
	320	86	4	1110	0,29	2,3	3,5	1720
	320	86	4	1110	0,29	2,3	3,5	1720
	320	86	4	1110	0,29	2,3	3,5	1720
	380	126	4	1960	0,32	2,1	3,1	2650
	380	126	4	1860	0,37	1,8	2,7	2500
	380	126	4	1860	0,37	1,8	2,7	2500
380	126	4	1860	0,37	1,8	2,7	2500	
380	126	4	1860	0,37	1,8	2,7	2500	
380	126	4	1860	0,37	1,8	2,7	2500	
190	260	52	2	465	0,18	3,7	5,5	900
	260	52	2	465	0,18	3,7	5,5	900
	290	75	2,1	915	0,23	3	4,4	1530
	290	75	2,1	915	0,23	3	4,4	1530
	290	100	2,1	1050	0,37	1,8	2,7	1980
	290	100	2,1	980	0,34	2	3	1810

Spherical Roller Bearings

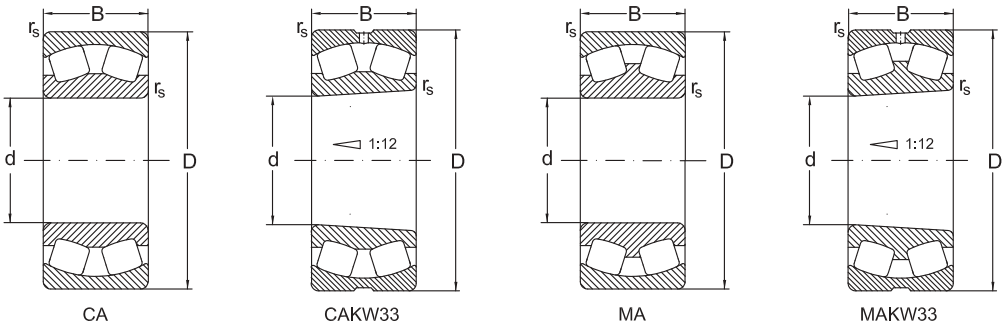

d	y ₀	Speed limit		Designation	Mass
		grease	oil	Bearing	
mm		min ⁻¹			kg
180	2,1	1100	1400	23136 MBW33	28,09
	2,1	1100	1400	23136 MBKW33	27,7
	1,8	750	1000	23236 MBK	38,5
	1,8	750	1000	23236 MBW33	39,81
	1,8	750	1000	23236 MBKW33	38,36
	2,5	1100	1500	22236 C	33,13
	2,5	1100	1500	22236 CK	32,58
	2,5	1100	1500	22236 CKW33	32,11
	2,5	1100	1500	22236 CW33	32,66
	2,3	1100	1400	22236 MBK	29
	2,3	1100	1400	22236 MB	29,69
	2,3	1100	1400	22236 MBW33	29,54
	2,3	1100	1400	22236 MBKW33	28,84
	2,1	900	1200	22336C	72,5
	1,8	850	1100	22336 MBK	68
	1,8	850	1100	22336 MAC4F80W33	68,8
	1,8	850	1100	22336 MB	71,2
	1,8	850	1100	22336 MBW33	68,71
1,8	850	1100	22336 MBKW33	66,45	
190	3,6	1100	1500	23938 M	8,46
	3,6	1100	1500	23938 MBK	8,2
	2,9	1300	1700	23038C	16,08
	2,9	1300	1700	23038 CK	15,8
	1,8	950	1200	24038 C	25
	2	850	1100	24038 MB	24,5

Spherical Roller Bearings

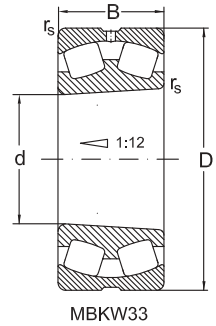
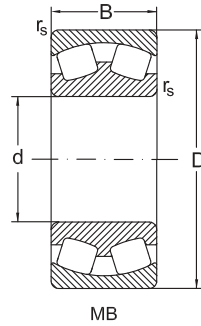
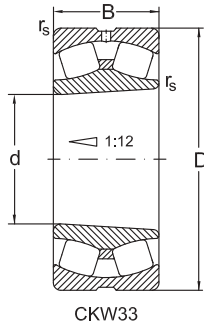
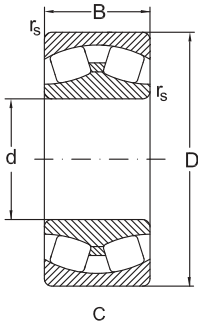

Dimensions				Basic radial load. Factors				
d	D	B	r_s min.	dyn. C_r	e	y_1	y_2	stat. C_{0r}
mm				kN	kN			
190	290	100	2,1	980	0,34	2	3	1810
	320	104	3	1320	0,33	2	3	2290
	320	104	3	1320	0,33	2	3	2290
	320	128	3	1540	0,37	1,8	2,7	2750
	320	128	3	1540	0,37	1,8	2,7	2750
	320	128	3	1330	0,35	1,9	2,9	2320
	320	128	3	1330	0,36	1,9	2,9	2320
	340	92	4	1330	0,26	2,6	3,9	2040
	340	92	4	1330	0,26	2,6	3,9	2040
	340	92	4	1220	0,29	2,3	3,4	1870
	340	120	4	1750	0,35	1,9	2,9	2880
	340	120	4	1750	0,35	1,9	2,9	2880
	340	120	4	1610	0,36	1,9	2,8	2640
	400	132	5	1900	0,37	1,8	2,7	2700
	400	132	5	1900	0,37	1,8	2,7	2700
	200	280	60	2,1	525	0,2	3,4	5,1
280		60	2,1	525	0,2	3,4	5,1	1020
310		82	2,1	1060	0,23	2,9	4,3	1760
310		82	2,1	1060	0,23	2,9	4,3	1760
310		109	2,1	1140	0,35	1,9	2,9	2280
310		109	2,1	1100	0,35	1,9	2,9	2200
310		109	2,1	1100	0,35	1,9	2,9	2200
340		112	3	1370	0,35	1,9	2,9	2460
340		112	3	1370	0,35	1,9	2,9	2460
340		140	3	1700	0,4	1,6	2,4	3000

Spherical Roller Bearings

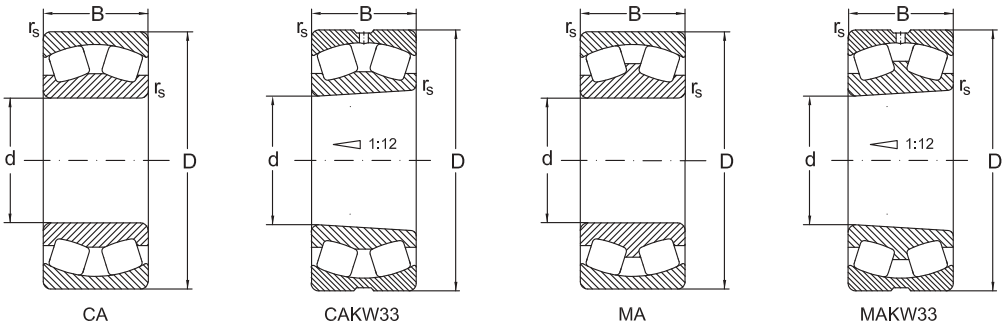

d	y ₀	Speed limit		Designation	Mass
		grease	oil	Bearing	
mm		min ⁻¹			kg
190	2	850	1100	24038 MBK30	24
	2	1100	1400	23138 MB	36,6
	2	1100	1400	23138 MBK	36,09
	1,8	670	900	24138 CAW33	41,65
	1,8	670	900	24138 CAK30W33	41,4
	1,8	650	850	24138 MBW33	41,79
	1,8	650	850	24138 MBK30W33	41,4
	2,5	1100	1400	22238C	37,2
	2,5	1100	1400	22238CK	36,8
	2,3	1000	1300	22238 MBW33	36,53
	1,8	850	1100	23238C	52,4
	1,8	850	1100	23238CK	52,4
	1,8	750	1000	23238 MBW33	47,83
	1,8	750	1000	22338MB	81,2
200	1,8	750	1000	22338 MBK	80,5
	3,3	1100	1400	23940 MBW33	11,4
	3,3	1100	1400	23940 MBKW33	11
	2,8	1300	1700	23040 CW33	22,4
	2,8	1300	1700	23040 CKW33	21,8
	1,9	850	1100	24040 CW33	31
	1,9	750	1000	24040 MBW33	30,5
	1,9	750	1000	24040 MBK30W33	29,7
	1,9	1100	1400	23140 MBW33	43,5
	1,9	1100	1400	23140 MBKW33	43,5
1,6	800	1000	24140 CW33	52,5	

Spherical Roller Bearings

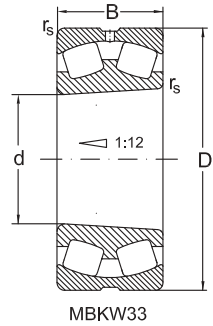
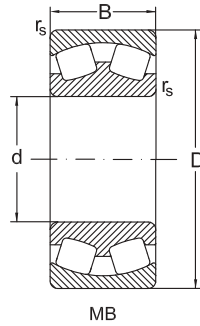
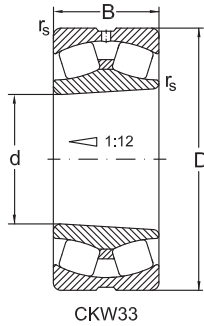
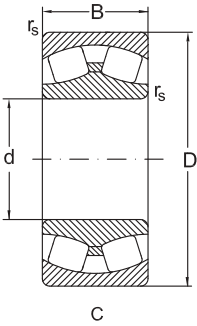

Dimensions				Basic radial load. Factors				
d	D	B	r _s min.	dyn. C _r	e	y ₁	y ₂	stat. C _{0r}
mm				kN				
200	340	140	3	1700	0,14	1,6	2,4	3000
	360	98	4	1250	0,29	2,3	3,9	2020
	360	98	4	1250	0,29	2,3	3,9	2020
	360	128	4	1620	0,35	1,9	2,9	2590
	360	128	4	1620	0,35	1,9	2,9	2590
	420	138	5	1910	0,36	1,8	2,8	2750
	420	138	5	1910	0,36	1,8	2,8	2750
220	300	60	2,1	625	0,18	3,8	5,6	1344
	300	60	2,1	625	0,18	3,8	5,6	1344
	340	90	3	1025	0,26	2,6	3,8	1730
	340	90	3	1025	0,26	2,6	3,8	1730
	340	118	3	1400	0,34	2	2,9	2700
	340	118	3	1400	0,34	2	2,9	2700
	370	150	4	1900	0,41	1,6	2,4	3450
	370	150	4	1900	0,41	1,6	2,4	3450
	370	120	4	1515	0,3	2,3	3,4	2509
	370	120	4	1515	0,3	2,3	3,4	2509
	400	108	4	1545	0,29	2,3	3,4	2300
	400	108	4	1545	0,29	2,3	3,4	2300
	400	144	4	2065	0,35	1,9	2,9	3380
	400	144	4	2065	0,35	1,9	2,9	3380
	460	145	5	2380	0,36	1,8	2,8	3407
460	145	5	2380	0,36	1,8	2,8	3407	
240	320	60	2,1	600	0,17	4,1	6	1170
	320	60	2,1	600	0,17	4,1	6	1170

Spherical Roller Bearings

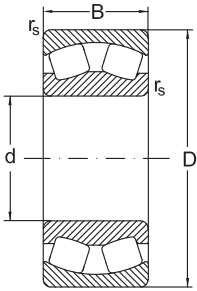

CA

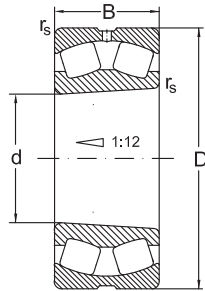

CAKW33

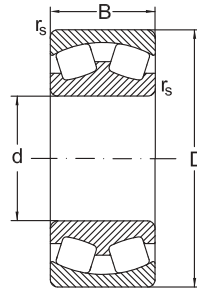

MA

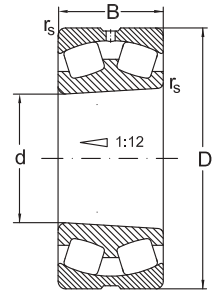

MAKW33

d	y ₀	Speed limit		Designation	Mass
		grease	oil	Bearing	
mm		min ⁻¹			kg
200	1,6	800	1000	24140 CK30W33	52,5
	2,3	1100	1400	22240 CW33	44,4
	2,3	1100	1400	22240 CKW33	44,4
	1,8	750	1000	23240 CW33	58,4
	1,8	750	1000	23240 CKW33	58,4
	1,8	670	900	22340 MBW33	91,8
	1,8	670	900	22340 MBKW33	91,8
220	3,7	1100	1500	23944 MBW33	13
	3,7	1100	1500	23944 MBKW33	13
	2,5	900	1200	23044 MBW33	31
	2,5	900	1200	23044 MBKW33	31
	1,9	750	1000	24044 MBW33	39,5
	1,9	750	1000	24044 MBK30W33	39,5
	1,6	700	900	24144 MBW33	65,5
	1,6	700	900	24144 MBK30W33	65,5
	2,2	1000	1300	23144 MBKW33	52
	2,2	1000	1300	23144 MBW33	52
	2,3	900	1200	22244 CW33	61,4
	2,3	900	1200	22244 CKW33	61,4
	1,8	670	900	23244 CW33	79,5
	1,8	670	900	23244 CKW33	79,5
	1,8	700	950	22344 CW33	120
	1,8	700	950	22344 CKW33	120
240	4	1000	1300	23948 MBKW33	14
	4	1000	1300	23948 MBW33	14

Spherical Roller Bearings

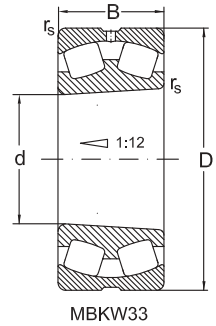
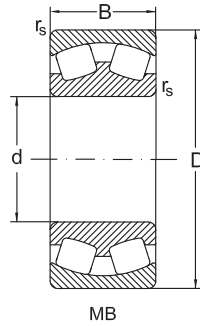
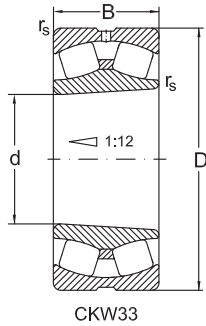
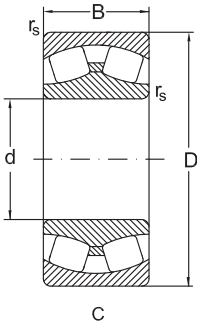

Dimensions				Basic radial load. Factors				
d	D	B	r_s min.	dyn. C_r	e	y_1	y_2	stat. C_{0r}
mm				kN	kN			
240	360	92	3	1160	0,3	2,3	3,4	2200
	360	92	3	1090	0,25	2,7	4,1	1960
	360	92	3	1090	0,25	2,7	4,1	1960
	360	118	3	1460	0,32	2,1	3,1	2841
	360	118	3	1460	0,32	2,1	3,1	2841
	400	128	4	1705	0,3	2,3	3,4	2863
	400	128	4	1705	0,3	2,3	3,4	2863
	400	160	4	1987	0,41	1,7	2,5	3530
	400	160	4	1987	0,41	1,7	2,5	3530
	440	120	4	1845	0,29	2,3	3,4	2763
	440	120	4	1845	0,29	2,3	3,4	2763
	440	160	4	2530	0,35	1,9	2,9	4600
	440	160	4	2530	0,35	1,9	2,9	4600
	500	155	5	2650	0,31	2,2	3,3	4000
500	155	5	2650	0,31	2,2	3,3	4000	
260	360	75	2,1	845	0,19	3,5	5,3	1604
	360	75	2,1	845	0,19	3,5	5,3	1604
	400	104	4	1500	0,26	2,6	3,9	2800
	400	104	4	1500	0,26	2,6	3,9	2800
	400	140	4	1775	0,35	1,9	2,9	3494
	400	140	4	1775	0,35	1,9	2,9	3494
	440	180	4	2500	0,42	1,6	2,4	5100
	440	180	4	2500	0,42	1,6	2,4	5100
	440	144	4	2153	0,31	2,2	3,3	3673
	440	144	4	2153	0,31	2,2	3,3	3673

Spherical Roller Bearings

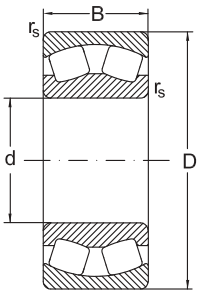

CA

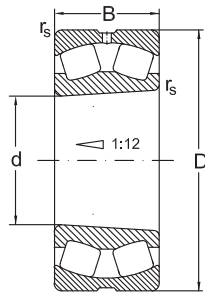

CAKW33

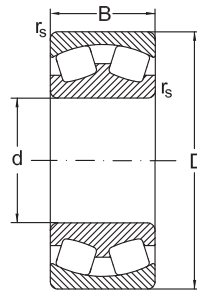

MA

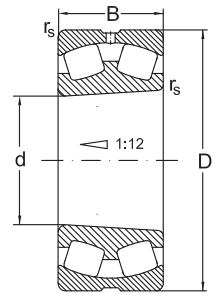

MAKW33

d	y ₀	Speed limit		Designation	Mass
		grease	oil		
mm		min ⁻¹		Bearing	kg
240	2,2	900	1100	23048 CW33	34,5
	2,7	800	1000	23048 MBKW33	33,9
	2,7	800	1000	23048 MBW33	33,9
	2,1	750	1000	24048 MBK30W33	42,5
	2,1	750	1000	24048 MBW33	42,5
	2,2	900	1200	23148 MBKW33	66
	2,2	900	1200	23148 MBW33	66
	1,6	530	700	24148 MBW33	79,5
	1,6	530	700	24148 MBK30W33	79,5
	2,3	850	1100	22248 CW33	83,2
	2,3	850	1100	22248 CKW33	83,2
	1,8	630	850	23248 CW33	109
	1,8	630	850	23248 CKW33	109
	2,2	560	750	22348 MBW33	151
	2,2	560	750	22348 MBKW33	151
	260	3,5	850	1100	23952 MBKW33
3,5		850	1100	23952 MBW33	24
2,6		750	950	23052 MBKW33	49
2,6		750	950	23052 MBW33	49
1,9		600	800	24052 MBK30W33	66
1,9		600	800	24052 MBW33	66
1,6		480	630	24152 MBW33	110
1,6		480	630	24152 MBK30W33	110
2,2		850	1100	23152 MBKW33	92,5
2,2		850	1100	23152 MBW33	92,5

Spherical Roller Bearings

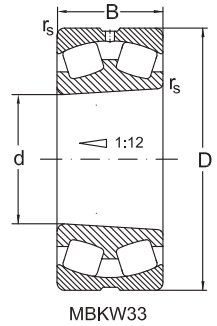
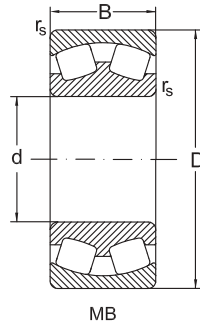
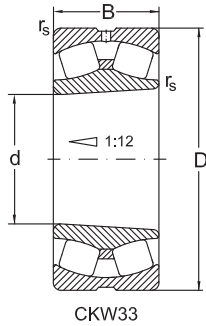
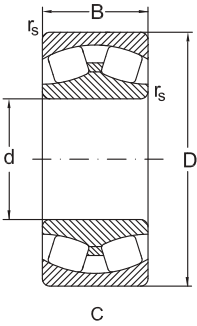

Dimensions				Basic radial load. Factors				
d	D	B	r _s min.	dyn. C _r	e	y ₁	y ₂	stat. C _{0r}
mm				kN	kN			
260	480	130	5	2190	0,29	2,3	3,4	3300
	480	130	5	2190	0,29	2,3	3,4	3300
	540	165	6	3125	0,36	1,8	2,8	4560
	540	165	6	3125	0,36	1,8	2,8	4560
280	380	75	2,1	950	0,18	3,8	5,6	2000
	380	75	2,1	950	0,18	3,8	5,6	2000
	420	106	4	1560	0,25	2,7	4,1	3000
	420	106	4	1560	0,25	2,7	4,1	3000
	420	140	4	2000	0,33	2	3	4000
	420	140	4	2000	0,33	2	3	4000
	460	146	5	2295	0,3	2,3	3,4	4050
	460	146	5	2295	0,3	2,3	3,4	4050
	460	180	5	2635	0,39	1,7	2,5	4848
	460	180	5	2635	0,39	1,7	2,5	4848
	500	130	5	2330	0,29	2,3	3,4	3600
	500	130	5	2330	0,29	2,3	3,4	3600
	500	176	5	2806	0,35	1,9	2,9	4645
	500	176	5	2806	0,35	1,9	2,9	4645
	580	175	6	3530	0,36	1,8	2,8	5208
	580	175	6	3530	0,36	1,8	2,8	5208
300	420	90	3	1175	0,2	3,4	5,1	2261
	420	90	3	1175	0,2	3,4	5,1	2261
	460	118	4	1960	0,25	2,7	4	3650
	460	118	4	1960	0,25	2,7	4	3650
	460	160	4	2385	0,35	2	2,9	4702

Spherical Roller Bearings

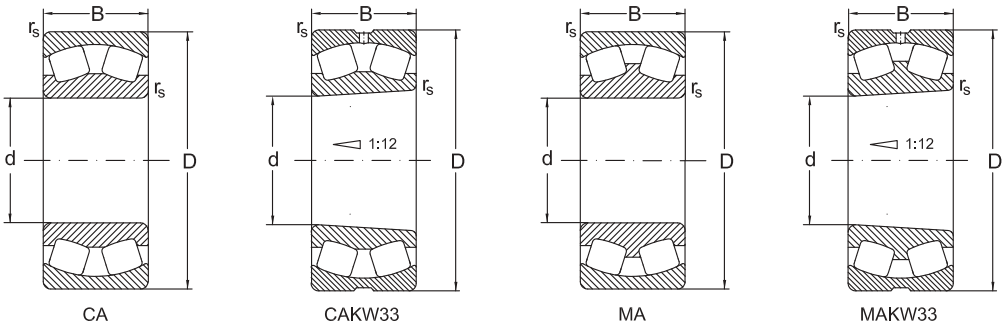

d	y ₀	Speed limit		Designation	Mass
		grease	oil		
mm		min ⁻¹		Bearing	kg
260	2,3	750	1000	22252 MBW33	107
	2,3	750	1000	22252 MBKW33	107
	1,8	600	800	22352 CW33	187
	1,8	600	800	22352 CKW33	187
280	3,7	900	1200	23956 MBKW33	26
	3,7	900	1200	23956 MBW33	26
	2,7	700	900	23056 MBKW33	52,5
	2,7	700	900	23056 MBW33	52,5
	2	560	750	24056 MBK30W33	68,5
	2	560	750	24056 MBW33	68,5
	2,2	750	1000	23156 MBKW33	98,5
	2,2	750	1000	23156 MBW33	98,5
	1,7	400	530	24156 MBW33	118
	1,7	400	530	24156 MBK30W33	118
	2,3	700	950	22256 MBW33	113
	2,3	700	950	22256 MBKW33	113
	1,8	480	630	23256 MBW33	153
	1,8	480	630	23256 MBKW33	153
	1,8	560	750	22356 CW33	235
	1,8	560	750	22356 CKW33	235
300	3,3	750	1000	23960 MBKW33	40
	3,3	750	1000	23960 MBW33	40
	2,6	630	800	23060 MBKW33	73,6
	2,6	630	800	23060 MBW33	73,6
	1,9	560	759	24060 MBK30W33	97

Spherical Roller Bearings

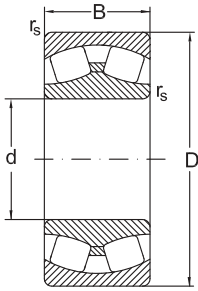

C

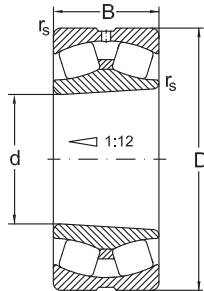

CKW33

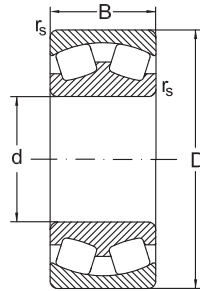

MB

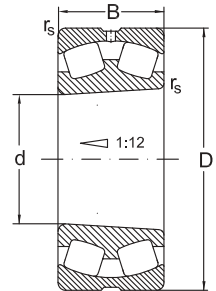

MBKW33

Dimensions				Basic radial load. Factors				
d	D	B	r_s min.	dyn. C_r	e	y_1	y_2	stat. C_{0r}
mm				kN	kN			
300	460	160	4	2385	0,35	2	2,9	4702
	500	160	5	2385	0,3	2,3	3,4	4485
	500	160	5	2385	0,3	2,3	3,4	4485
	500	200	5	3213	0,4	1,7	2,5	6011
	500	200	5	3213	0,4	1,7	2,5	6011
	540	140	5	2655	0,29	2,3	3,4	4230
	540	140	5	2655	0,29	2,3	3,4	4230
320	440	90	3	1215	0,19	3,6	5,4	2409
	440	90	3	1215	0,19	3,6	5,4	2409
	480	121	4	2040	0,25	2,7	4,1	4000
	480	121	4	2040	0,25	2,7	4,1	4000
	480	160	4	2500	0,33	2,1	3,1	5240
	480	160	4	2500	0,33	2,1	3,1	5240
	540	176	5	3115	0,34	2	3	6000
	540	176	5	3115	0,34	2	3	6000
	540	218	5	3750	0,41	1,7	2,5	7300
	540	218	5	3750	0,41	1,7	2,5	7300
	580	150	5	2997	0,29	2,5	3,7	4740
	580	150	5	2997	0,29	2,5	3,7	4740
	580	208	5	4130	0,35	1,9	2,9	7026
	580	208	5	4130	0,35	1,9	2,9	7026
340	440	90	3	1306	0,189	3,8	5,7	2691
	440	90	3	1306	0,189	3,8	5,7	2691
	520	133	5	2360	0,25	2,7	4	4500
	520	133	5	2360	0,25	2,7	4	4500

Spherical Roller Bearings

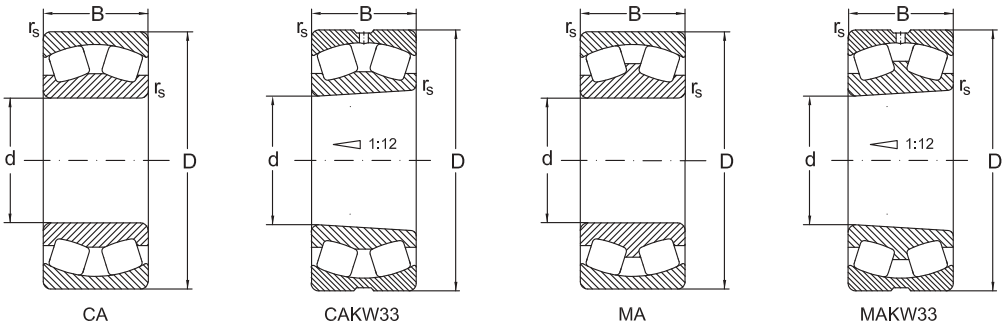

d	y ₀	Speed limit		Designation	Mass
		grease	oil	Bearing	
mm		min ⁻¹			kg
300	1,9	560	759	24060 MBW33	97
	2,2	700	950	23160 MBKW33	129
	2,2	700	950	23160 MBW33	129
	1,6	430	560	24160 MBW33	159
	1,6	430	560	24160 MBK30W33	159
	2,3	670	900	22260 CAKW33	142
	2,3	670	900	22260 CAW33	142
320	3,5	670	900	23964 MBKW33	42
	3,5	670	900	23964 MBW33	42
	2,7	600	750	23064 MBKW33	79,5
	2,7	600	750	23064 MBW33	79,5
	2	530	700	24064 MBK30W33	106
	2	530	700	24064 MBW33	106
	1,9	530	670	23164 MBW33	165
	1,9	530	670	23164 MBKW33	165
	1,6	400	530	24164 MBW33	215
	1,6	400	530	24164 MBK30W33	215
	2,5	630	580	22264 CAKW33	180
	2,5	630	580	22264 CAW33	180
	1,8	430	560	23264 MBW33	247
	1,8	430	560	23264 MBKW33	247
340	3,8	630	850	23968 CAKW33	47
	3,8	630	850	23698 CAW33	47,8
	2,6	560	700	23068 CAKW33	101
	2,6	560	700	23068 CAW33	105

Spherical Roller Bearings

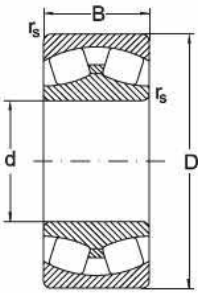

C

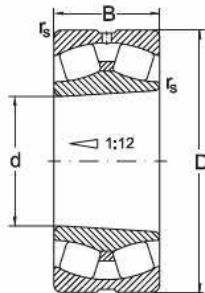

CKW33

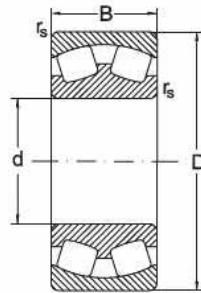

MB

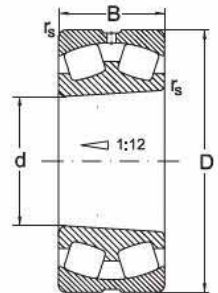

MBKW33

Dimensions				Basic radial load. Factors				
d	D	B	r_s min.	dyn. C_r	e	y_1	y_2	stat. C_{0r}
mm				kN				
340	520	180	5	2912	0,34	2	2,9	5961
	520	180	5	2912	0,34	2	2,9	5961
	580	190	5	3740	0,31	2,2	3,2	6640
	580	190	5	3740	0,31	2,2	3,2	6640
	580	243	5	4400	0,43	1,6	2,3	8500
	580	243	5	4400	0,43	1,6	2,3	8500
360	480	90	3	1030	0,17	4,1	6	3200
	480	90	3	1030	0,17	4,1	6	3200
	540	134	5	2450	0,25	2,7	4,1	4800
	540	134	5	2450	0,25	2,7	4,1	4800
	540	180	5	3150	0,33	2,1	3,1	6530
	540	180	5	3150	0,33	2,1	3,1	6530
	600	192	5	3810	0,33	2,3	3,4	7010
	600	192	5	3810	0,33	2,3	3,4	7010
	600	243	5	4500	0,41	1,6	2,4	9000
	600	243	5	4500	0,41	1,6	2,4	9000
	650	232	6	4880	0,35	1,9	2,9	8490
	650	232	6	4880	0,35	1,9	2,9	8490
380	520	106	4	1785	0,19	3,6	5,3	4000
	520	106	4	1785	0,19	3,6	5,3	4000
	560	135	5	2550	0,25	2,8	4,2	5300
	560	135	5	2550	0,25	2,8	4,2	5300
	560	180	5	3150	0,31	2,2	3,2	6710
	560	180	5	3150	0,31	2,2	3,2	6710
	620	194	5	3890	0,3	2,3	3,4	7540

Spherical Roller Bearings

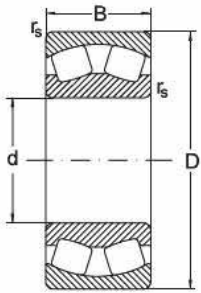

CA

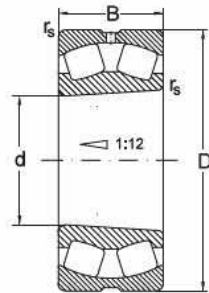

CAKW33

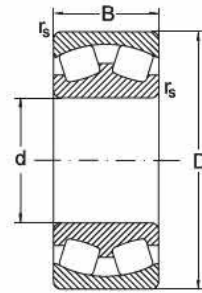

MA

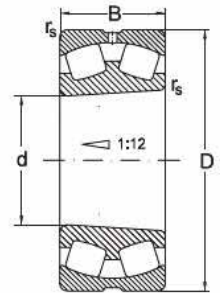

MAKW33

Spherical Roller Bearings

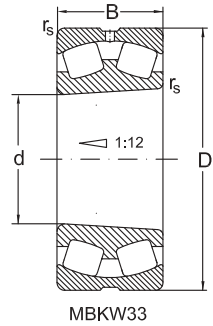
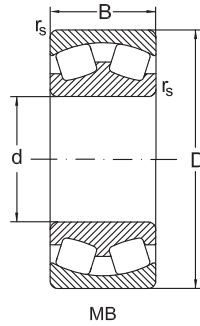
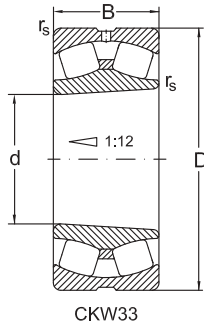
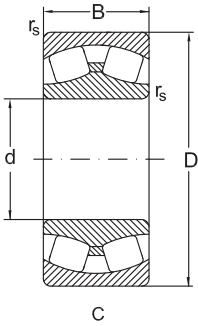

Dimensions				Basic radial load. Factors				
d	D	B	r _s min.	dyn. C _r	e	y ₁	y ₂	stat. C _{0r}
mm				kN	kN			
380	620	194	5	3890	0,3	2,3	3,4	7540
	620	243	5	4650	0,39	1,7	2,5	9500
	620	243	5	4650	0,39	1,7	2,5	9500
	680	240	6	5050	0,35	1,9	2,9	9660
	680	240	6	5050	0,35	1,9	2,9	9660
400	540	106	4	1850	0,18	3,7	5,5	3990
	540	106	4	1850	0,18	3,7	5,5	3990
	600	148	5	3050	0,24	2,8	4,1	6200
	600	148	5	3050	0,24	2,8	4,1	6200
	600	200	5	3610	0,33	2,1	3,1	7545
	600	200	5	3610	0,33	2,1	3,1	7545
	650	200	6	4500	0,28	2,4	3,6	7900
	650	200	6	4500	0,28	2,4	3,6	7900
	650	250	6	5100	0,39	1,7	2,6	10400
	650	250	6	5100	0,39	1,7	2,6	10400
	720	256	6	5950	0,35	1,9	2,9	10807
	720	256	6	5950	0,35	1,9	2,9	10807
	420	560	106	4	1960	0,18	3,8	5,7
560		106	4	1960	0,18	3,8	5,7	4130
620		150	5	3150	0,24	2,8	4,2	6550
620		150	5	3150	0,24	2,8	4,2	6550
620		200	5	4000	0,32	2,1	3,2	8800
620		200	5	4000	0,32	2,1	3,2	8800
700		224	6	4600	0,33	2	3	9000
700		224	6	4600	0,33	2	3	9000

Spherical Roller Bearings

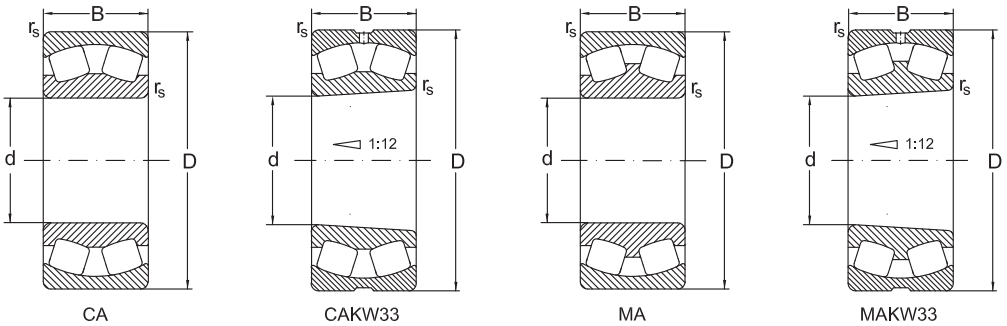

d	y ₀	Speed limit		Designation	Mass
		grease	oil		
mm		min ⁻¹		Bearing	kg
380	2,2	560	750	23176 CAW33	241
	1,7	400	500	24176 CAW33	279
	1,7	400	500	24176 CAK30W33	277
	1,8	400	530	23276 CAW33	390
	1,8	400	530	23276 CAKW33	367
400	3,6	600	800	23980 CAW33	72,9
	3,6	600	800	23980 CAKW33	68,2
	2,7	450	560	23080 CAKW33	143
	2,7	450	560	23080 CAW33	151
	2	430	460	24080 CAW33	198
	2	430	460	24080 CAK30W33	196
	2,5	530	700	23180 CAKW33	261
	2,5	530	700	23180 CAW33	270
	1,7	380	480	24180 CAW33	326
	1,7	380	480	24180 CAK30W33	312
	1,8	380	500	23280 CAW33	469
	1,8	380	500	23280 CAKW33	442
420	3,8	600	800	23984 CAKW33	78
	3,8	600	800	23984 CAW33	80,5
	2,8	450	560	23084 CAKW33	155
	2,8	450	560	23084 CAW33	162
	2,1	380	480	24084 CAK30W33	214
	2,1	380	480	24084 CAW33	217
	2	500	670	23184 CAW33	360
	2	500	670	23184 CAKW33	339

Spherical Roller Bearings

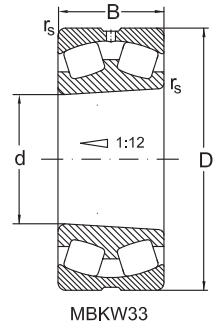
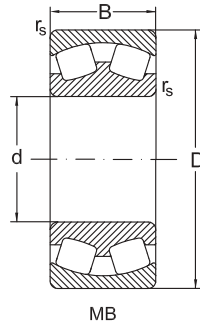
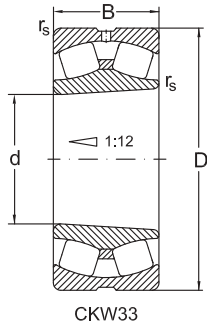
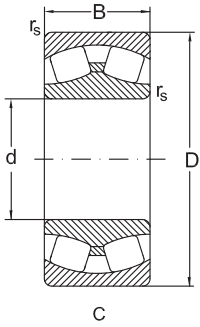

Spherical Roller Bearings

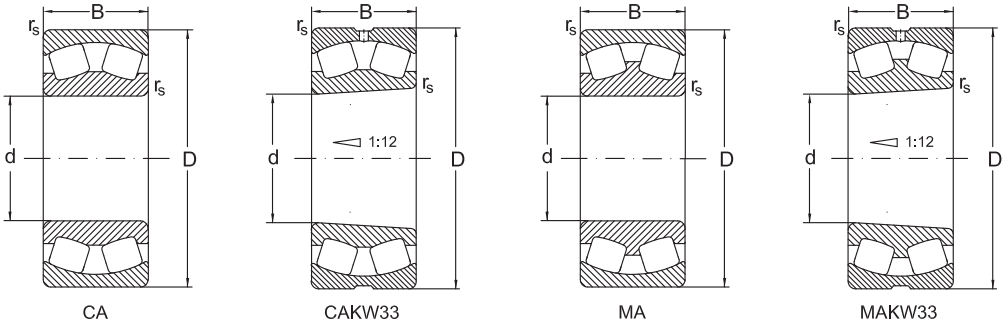

d	y ₀	Speed limit		Designation	Mass
		grease	oil		
mm		min ⁻¹		Bearing	kg
420	2	400	500	24184 CAW33	442
	2	400	500	24184 CAK30W33	407
	1,8	360	480	23284 CAW33	558
	1,8	360	480	23284 CAKW33	537
440	3,6	560	750	23988 CAKW33	98,3
	3,6	560	750	23988 CAW33	101
	2,8	430	530	23088 CAKW33	177
	2,8	430	530	23088 CAW33	190
	2,1	360	450	24088 CAK30W33	247
	2,1	360	450	24088 CAW33	250
	2,2	500	670	23188 CAW33	381
	2,2	500	670	23188 CAKW33	378
	1,7	340	430	24188 CAW33	453
	1,7	340	430	24188 CAK30W33	451
	1,8	360	480	23288 CAW33	615
	1,8	360	480	23288 CAKW33	586
460	3,8	530	700	23992 CAKW33	103
	3,8	530	700	23992 CAW33	111
	2,8	400	500	23092 CAKW33	204
	2,8	400	500	23092 CAW33	208
	2,1	380	500	24092 CAK30W33	279
	2,1	380	500	24092 CAW33	282
	2,2	480	630	23192 CAW33	447
	2,2	480	630	23192 CAKW33	420
	1,7	320	400	24192 CAW33	582

Spherical Roller Bearings

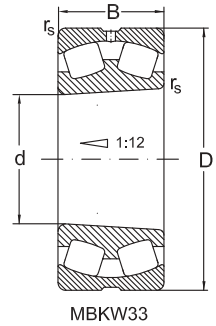
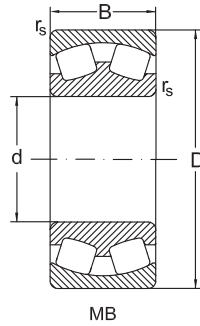
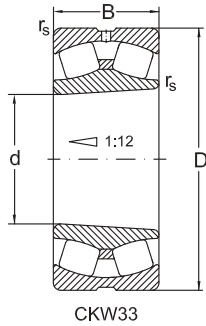
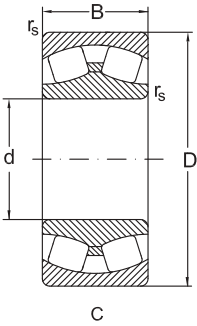

Dimensions				Basic radial load. Factors				
d	D	B	r_s min.	dyn. C_r	e	y_1	y_2	stat. C_{0r}
mm				kN	kN			
460	760	300	7,5	7500	0,39	1,7	2,6	15600
	830	296	7,5	7560	0,35	1,9	2,9	13970
	830	296	7,5	7560	0,35	1,9	2,9	13970
480	650	128	5	2525	0,18	3,8	5,6	5500
	650	128	5	2525	0,18	3,8	5,6	5500
	700	165	6	3800	0,23	2,9	4,3	8150
	700	165	6	3800	0,23	2,9	4,3	8150
	700	218	6	4900	0,3	2,3	3,3	11200
	700	218	6	4900	0,3	2,3	3,3	11200
	790	248	7,5	5800	0,3	2,3	3,4	11800
	790	248	7,5	5800	0,3	2,3	3,4	11800
	790	308	7,5	8000	0,39	1,8	2,6	16600
	790	308	7,5	8000	0,39	1,8	2,6	16600
	870	310	7,5	8800	0,37	1,8	2,7	17000
	870	310	7,5	8800	0,37	1,8	2,7	17000
	500	670	128	5	2500	0,17	3,9	5,8
670		128	5	2500	0,17	3,9	5,8	6090
720		167	6	3900	0,22	3	4,5	8500
720		167	6	3900	0,22	3	4,5	8500
720		218	6	4900	0,29	2,3	3,5	11200
720		218	6	4900	0,29	2,3	3,5	11200
830		264	7,5	6550	0,3	2,3	3,4	13200
830		264	7,5	6550	0,3	2,3	3,4	13200
830		325	7,5	8650	0,39	1,7	2,6	18300
830		325	7,5	8650	0,39	1,7	2,6	18300

Spherical Roller Bearings

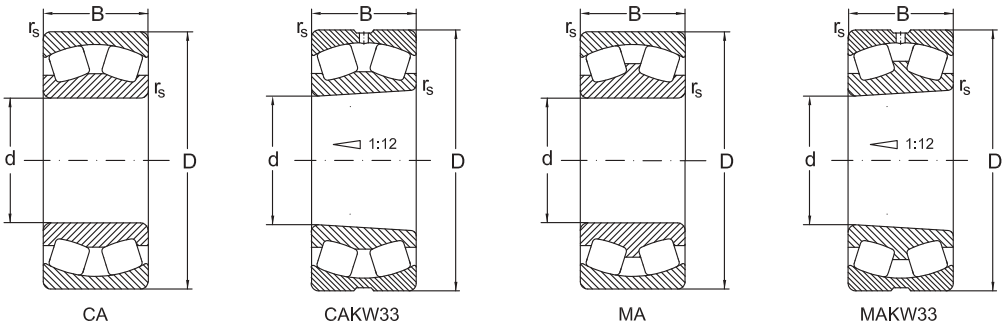

d	y ₀	Speed limit		Designation	Mass
		grease	oil		
mm		min ⁻¹		Bearing	kg
460	1,7	320	400	24192 CAK30W33	578
	1,9	340	450	23292 CAW33	700
	1,9	340	450	23292 CAKW33	685
480	3,7	450	600	23996 CAW33	126
	3,7	450	600	23996 CAKW33	121
	2,8	380	480	23096 CAKW33	208
	2,8	380	480	23096 CAW33	222
	2,2	340	430	24096 CAK30W33	289
	2,2	340	430	24096 CAW33	291
	2,2	450	600	23196 CAW33	508
	2,2	450	600	23196 CAKW33	470
	1,7	320	400	24196 CAW33	705
	1,7	320	400	24196 CAK30W33	700
	1,8	340	430	23296 CAW33	830
	1,8	340	430	23296 CAKW33	806
500	3,8	480	630	239/500 CAKW33	124
	3,8	480	630	239/500 CAW33	132
	2,9	380	480	230/500 CAKW33	219
	2,9	380	480	230/500 CAW33	233
	2,3	320	400	240/500 CAK30W33	293
	2,3	320	400	240/500 CAW33	297
	2,2	430	560	231/500 CAKW33	556
	2,2	430	560	231/500 CAW33	588
	1,7	300	380	241/500 CAW33	725
	1,7	300	380	241/500 CAK30W33	717

Spherical Roller Bearings

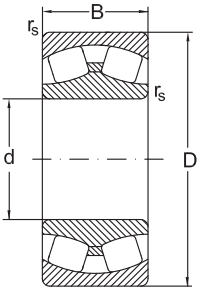

C

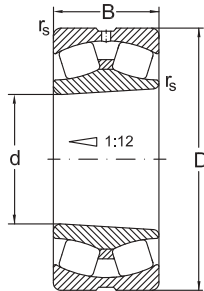

CKW33

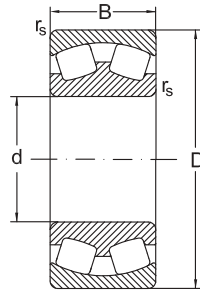

MB

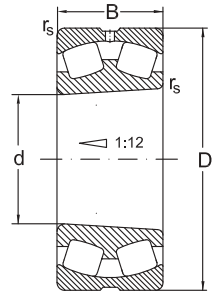

MBKW33

Dimensions				Basic radial load. Factors				
d	D	B	r_s min.	dyn. C_r	e	y_1	y_2	stat. C_{0r}
mm				kN	kN			
500	920	336	7,5	9650	0,38	1,8	2,7	18300
	920	336	7,5	9650	0,38	1,8	2,7	18300
530	710	136	5	2980	0,18	3,8	5,7	6755
	710	136	5	2980	0,18	3,8	5,7	6755
	780	185	6	4400	0,22	3	4,5	9500
	780	185	6	4400	0,22	3	4,5	9500
	780	250	6	5640	0,31	2,2	3,2	12800
	780	250	6	5640	0,31	2,2	3,2	12800
	870	335	7,5	9500	0,38	1,8	2,6	20000
	870	335	7,5	9500	0,38	1,8	2,6	20000
	870	272	7,5	7625	0,3	2,3	3,4	15000
	870	272	7,5	7625	0,3	2,3	3,4	15000
560	750	140	5	3100	0,17	4	5,9	7650
	750	140	5	3100	0,17	4	5,9	7650
	820	195	6	5100	0,23	2,9	4,4	11000
	820	195	6	5100	0,23	2,9	4,4	11000
	820	258	6	6400	0,31	2,2	3,3	14600
	820	258	6	6400	0,31	2,2	3,3	14600
	920	280	7,5	8294	0,3	2,3	3,4	16295
	920	280	7,5	8294	0,3	2,3	3,4	16295
	920	355	7,5	10600	0,38	1,8	2,6	22400
	920	355	7,5	10600	0,38	1,8	2,6	22400
600	800	150	5	3450	0,17	4	5,9	8650
	800	150	5	3450	0,17	4	5,9	8650
	870	200	6	5700	0,22	3,1	4,6	12500

Spherical Roller Bearings

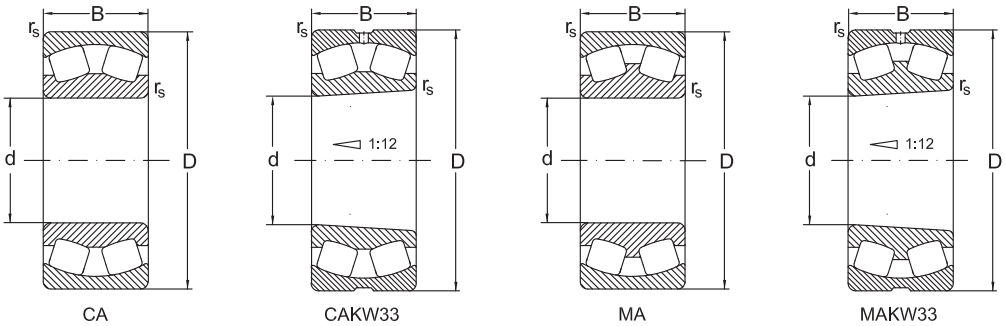

d	y ₀	Speed limit		Designation	Mass
		grease	oil		
mm		min ⁻¹		Bearing	kg
500	1,7	320	400	232/500 CAW33	1010
	1,7	320	400	232/500 CAKW33	985
530	3,8	450	600	239/530 CAW33	160
	3,8	450	600	239/530 CAKW33	146
	3	340	430	230/530 CAW33	321
	3	340	430	230/530 CAKW33	291
	2,1	340	450	240/530 CAW33	415
	2,1	340	450	240/530 CAK30W33	410
	1,7	280	360	241/530 CAW33	838
	1,7	280	360	241/530 CAK30W33	830
	2,2	400	530	231/530 CAKW33	643
	2,2	400	530	231/530 CAW33	665
560	3,9	340	430	239/560 CAKW33	169
	3,9	340	430	239/560 CAW33	181
	2,9	320	400	230/560 CAKW33	339
	2,9	320	400	230/560 CAW33	358
	2,2	280	360	240/560 CAK30W33	469
	2,2	280	360	240/560 CAW33	463
	2,2	380	500	231/560 CAKW33	737
	2,2	380	500	231/560 CAW33	760
	1,7	260	340	241/560 CAW33	982
	1,7	260	340	241/560 CAK30W33	974
600	3,9	320	400	239/600 CAKW33	210
	3,9	320	400	239/600 CAW33	224
	3	300	380	230/600 CAKW33	388

Spherical Roller Bearings

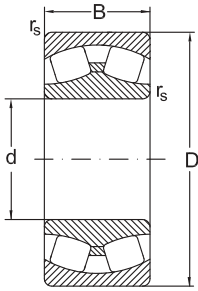

C

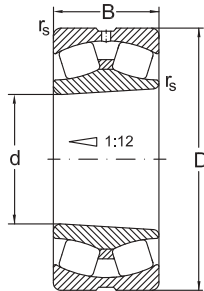

CKW33

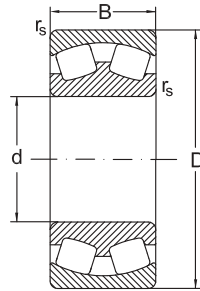

MB

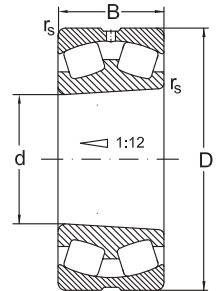

MBKW33

Dimensions				Basic radial load. Factors				
d	D	B	r _s min.	dyn. C _r	e	y ₁	y ₂	stat. C _{0r}
mm				kN	kN			
600	870	200	6	5700	0,22	3,1	4,6	12500
	870	272	6	7100	0,31	2,2	3,3	16600
	870	272	6	7100	0,31	2,2	3,3	16600
	980	300	7,5	9000	0,31	1,8	2,7	19300
	980	300	7,5	9000	0,31	1,8	2,7	19300
	980	375	7,5	11600	0,38	1,8	2,7	26000
	980	375	7,5	11600	0,38	1,8	2,7	26000
630	850	165	6	4290	0,18	3,8	5,7	9910
	850	165	6	4290	0,18	3,8	5,7	9910
	920	212	7,5	6300	0,31	2,2	3,3	14000
	920	212	7,5	6300	0,31	2,2	3,3	14000
	920	290	7,5	8000	0,31	2,2	3,3	19000
	920	290	7,5	8000	0,31	2,2	3,3	19000
670	900	170	6	4300	0,17	4	5,9	10600
	900	170	6	4300	0,17	4	5,9	10600
	980	230	7,5	7200	0,22	3	4,5	16000
	980	230	7,5	7200	0,22	3	4,5	16000
	980	308	7,5	9000	0,31	2,2	3,3	21600
	980	308	7,5	9000	0,31	2,2	3,3	21600
710	950	180	6	4800	0,18	3,8	5,7	12000
	950	180	6	4800	0,18	3,8	5,7	12000
750	1000	185	6	5200	0,17	4	5,9	12900
	1000	185	6	5200	0,17	4	5,9	12900

Spherical Roller Bearings

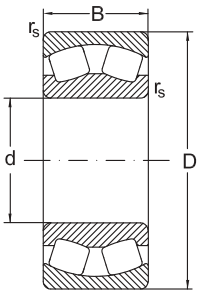

CA

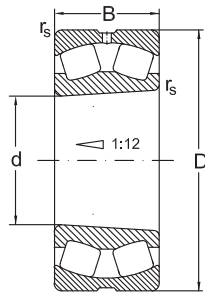

CAKW33

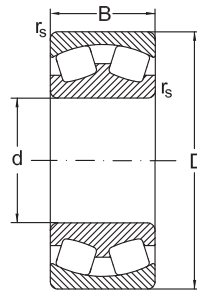

MA

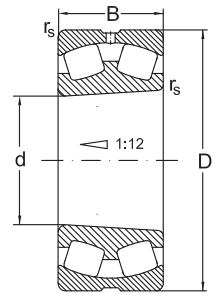

MAKW33

d	y ₀	Speed limit		Designation	Mass
		grease	oil	Bearing	
mm		min ⁻¹			kg
600	3	300	380	230/600 CAW33	409
	2,2	260	340	240/600 CAK30W33	534
	2,2	260	340	240/600 CAW33	540
	2,2	280	360	231/600 CAW33	929
	2,2	280	360	231/600 CAKW33	901
	1,8	240	320	241/600 CAW33	1180
	1,8	240	320	241/600 CAK30W33	1170
630	3,7	380	500	239/630 CAKW33	283
	3,7	380	500	239/630 CAW33	292
	2,2	260	340	230/630 CAKW33	496
	2,2	260	340	230/630 CAW33	502
	2,2	260	340	240/630 CAK30W33	649
	2,2	260	340	240/630 CAW33	660
670	3,9	280	360	239/670 CAKW33	310
	3,9	280	360	239/670 CAW33	320
	2,9	260	340	230/670 CAKW33	590
	2,9	260	340	230/670 CAW33	600
	2,2	240	320	240/670 CAK30W33	795
	2,2	240	320	240/670 CAW33	802
710	3,8	260	340	239/710 CAKW33	336
	3,8	260	340	239/710 CAW33	355
750	3,9	260	340	239/750 CAKW33	394
	3,9	260	340	239/750 CAW33	426



Thrust Ball Bearings

Standards, Boundary dimensions

Standard plans	DIN 616
Thrust ball bearings single direction	DIN 711
Thrust ball bearings double direction	DIN 715
Seating washers	DIN 711

General

Thrust Ball Bearings are separable axial bearings that are produced in both single and double direction acting design. To assist in simple effective mounting or dismounting the bearing washers, seating's, and cage and ball assemblies, may be individually mounted in their arrangement location.

Thrust ball bearings may accommodate comparatively high axial loads but they must not be exposed to any radial forces.

Due to their specific kinematic behavior, thrust ball bearings are only suitable for low to medium operating speeds.

Furthermore, they require minimum axial loads for their optimum function. Since thrust ball bearings do not compensate any misalignment, they are also frequently used in conjunction with sphered housing washers and seating washers.

Design variants (see drawing on next page)

Thrust ball bearings are produced in both, single direction and double direction design. The most important design variants are shown on the next page.

Single direction thrust ball bearings consist of a **shaft washer**, a **housing washer** and a **ball and cage thrust assembly** (see figure a, b and c).

These bearings are able to accommodate axial loads in one direction only.

Single direction thrust ball bearings of series **511, 512, 513** and **514** have plain housing washers, (see figure a).

For applications where some misalignment may occur, single direction thrust ball bearings of the series **532, 533** and **534** are also available with sphered housing washers, figure b.

These bearings may be applied either direct to sphered shaped bearings seats or, they may be used together with **seating washers** of series **U2, U3** or **U4** (see figure c).

Unlike single direction thrust ball bearing types, **double direction thrust ball bearings** are suitable to guide the shaft in both directions (see figure d, e and f).

These bearings consist of two washers, **two balls and cage thrust assemblies** with one common **shaft washer** located centrally in between.

Double direction thrust ball bearings are also available in both designs, with **at housing washers** (series **522, 523** and **524** figure d) and with sphered housing washers (series **542, 543** and **544** figure e).

For compensation of possible aligning errors the double direction thrust ball bearings may be used in conjunction with **Seating Washers** (series **U2, U3** and **U4**, see figure f).

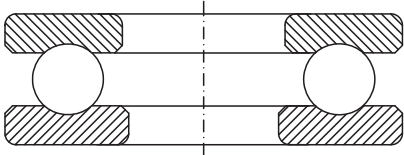

a

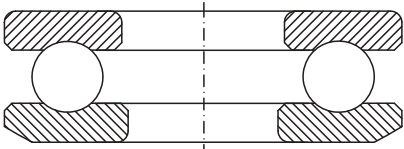

b

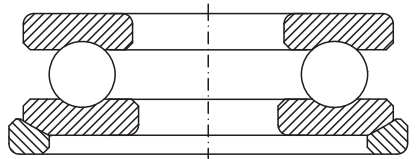

c

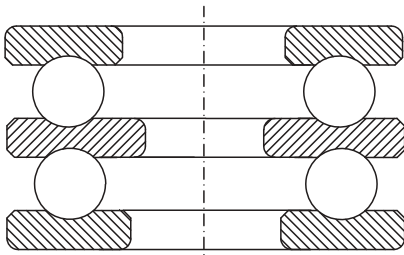

d

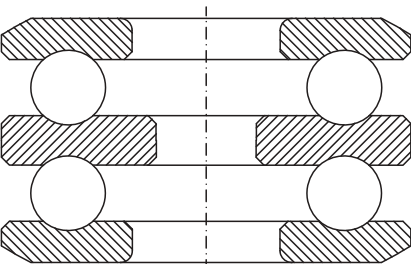

e

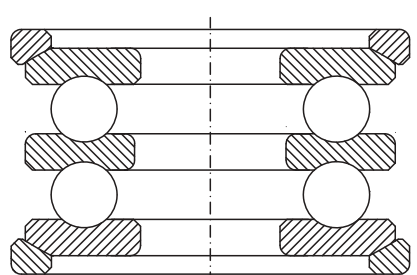

f

Misalignment

All thrust ball bearings with flat housing washers do not allow any misalignment.

The contacting surfaces of both shaft and housing seats must be parallel. Misalignments can only be accommodated by using Thrust Ball bearings with **sphered housing washers**.

Cages

ART thrust ball bearings are normally fitted with pressed steel cages as standard.

For larger thrust ball bearings solid brass cages (suffix **M**), or solid steel cages (suffix **F**), are fitted as standard.

Tolerances

ART thrust ball bearings are produced to normal class tolerance class (**PN**) as standard.

For applications of higher dimensional and geometrical accuracy these bearings are produced to precision tolerance class (e.g. **P6**) on order request.

For detailed values of the tolerance classes see chapter **Bearing tolerances** (see page 39-40).

Minimum load:

Thrust ball bearings require a certain minimum axial load to ensure a satisfactory operating function.

To prevent excessive sliding friction, the minimum axial load applied should be greater than **4%** of the axial bearing dynamic load rating **Ca**.

Where such a minimum axial load is not possible, the load must be increased by effective measures, (i.e. preloading the bearing) using pressure washers or springs.

Equivalent dynamic bearing load

Thrust ball bearings are pure axial bearings, there are not able to accommodate any radial loads, therefore:

$$P = F_a$$

Equivalent static bearing load

For thrust ball bearings:

$$P_0 = F_a$$

Abutment and Fillet dimensions for thrust ball bearings

The bearing washer must contact adjacent parts with their face sides only. The radii of bearing shoulder fillet radii of the shaft or housing shoulders.

Therefore fillet radius (r_g) must be smaller than the minimum fillet dimension of the bearing rings (r_s) as listed in the bearing tables.

Abutment and Fillet dimensions for Thrust Ball bearings of series 511, 512, 513 and 514 [mm]

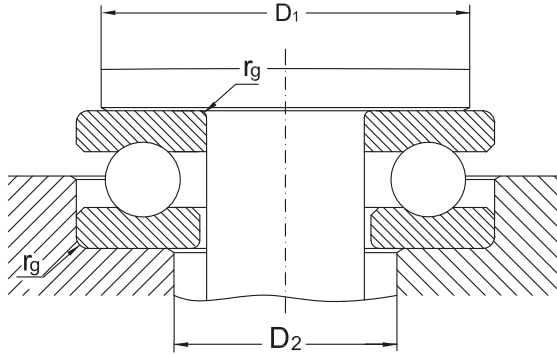

Shaft $\varnothing d_1$	Bore reference number	Bearing Series											
		511			512			513			514		
		D_1 min	D_2 min	r_g max	D_1 min	D_2 min	r_g max	D_1 min	D_2 min	r_g max	D_1 min	D_2 min	r_g max
mm													
10	0	18	16	0,3	20	16	0,6	-	-	-	-	-	-
12	1	20	18	0,3	22	18	0,6	-	-	-	-	-	-
15	2	23	20	0,3	25	22	0,6	-	-	-	-	-	-
17	3	25	22	0,3	28	24	0,6	-	-	-	-	-	-
20	4	29	26	0,3	32	28	0,6	-	-	-	-	-	-
25	5	35	32	0,6	38	34	0,6	41	36	1	46	39	1
30	6	40	37	0,6	43	39	0,6	48	42	1	54	46	1
35	7	45	42	0,6	51	46	1	55	48	1	62	53	1
40	8	52	48	0,6	57	51	1	63	55	1	70	60	1
45	9	57	53	0,6	62	56	1	69	61	1	78	67	1
50	10	62	58	0,6	67	61	1	77	68	1	86	74	1,5
55	11	69	64	0,6	76	69	1	85	75	1	94	81	1,5
60	12	75	70	1	81	74	1	90	80	1	102	88	1,5
65	13	80	75	1	86	79	1	95	85	1	110	95	2
70	14	85	80	1	91	84	1	103	92	1	118	102	2
75	15	90	85	1	96	89	1	111	99	1,5	126	109	2
80	16	95	90	1	101	94	1	116	104	1,5	134	116	2,1
85	17	100	95	1	109	101	1	124	111	1,5	142	123	2,1
90	18	108	102	1	117	108	1	129	116	1,5	150	130	2,1
100	20	121	114	1	130	120	1	142	128	1,5	166	144	2,5
110	22	131	124	1	140	130	1	158	142	2	182	158	2,5
120	24	141	134	1	150	140	1	174	156	2,1	198	172	3
130	26	154	146	1	166	154	1	187	168	2,1	214	186	3
140	28	164	156	1	176	164	1	200	180	2,1	224	196	3
150	30	174	166	1	189	176	1	210	190	2,1	240	210	3

Abutment and Fillet dimensions for Thrust Ball bearings of series 511, 512 and 513 [mm]

Shaft	Bore reference number	Bearing Series								
		511			512			513		
$\varnothing d_1$		D ₁ min	D ₂ min	r _g max	D ₁ min	D ₂ min	r _g max	D ₁ min	D ₂ min	r _g max
mm										
160	32	184	176	1	199	186	1,5	226	204	2,5
170	34	197	188	1	212	198	1,5	236	214	2,5
180	36	207	198	1	222	208	1,5	252	228	2,5
190	38	220	210	1	238	222	2	268	242	3
200	40	230	220	1	248	232	2	284	256	3
220	44	250	240	1	268	252	2	-	-	-
240	48	276	264	1,5	300	280	2,1	-	-	-
260	52	296	284	1,5	320	300	2,1	-	-	-
280	56	322	308	1,5	340	320	2,1	-	-	-
300	60	348	332	2	372	348	2,5	-	-	-
320	64	368	352	2	392	368	2,5	-	-	-
340	68	388	372	2	412	388	2,5	-	-	-
360	72	408	392	2	444	416	3	-	-	-
380	76	428	412	2	-	-	-	-	-	-
400	80	448	432	2	-	-	-	-	-	-
420	84	468	452	2	-	-	-	-	-	-
440	88	500	480	2,1	-	-	-	-	-	-
460	92	520	500	2,1	-	-	-	-	-	-
480	96	540	520	2,1	-	-	-	-	-	-
500	/500	560	540	2,1	-	-	-	-	-	-
530	/530	596	574	2,5	-	-	-	-	-	-
560	/560	626	604	2,5	-	-	-	-	-	-

Abutment and Fillet dimensions for Thrust Ball bearings of series 532, 533, and 534 [mm]

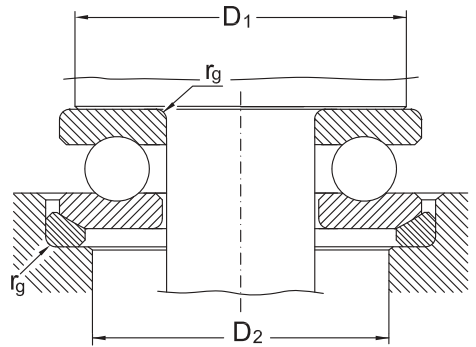
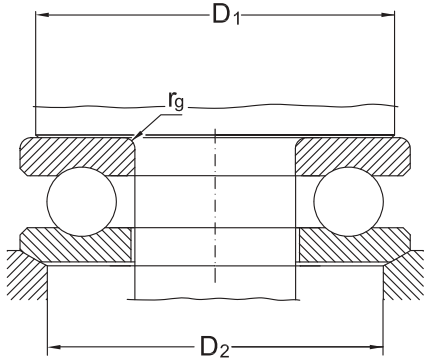

Shaft $\varnothing d_1$	Bore reference number	Bearing Series								
		532			533			534		
		D_1 min	D_2 min	r_g max	D_1 min	D_2 min	r_g max	D_1 min	D_2 min	r_g max
mm										
10	0	20	18	0,6	-	-	-	-	-	-
12	1	22	20	0,6	-	-	-	-	-	-
15	2	25	24	0,6	-	-	-	-	-	-
17	3	28	26	0,6	-	-	-	-	-	-
20	4	32	30	0,6	-	-	-	-	-	-
25	5	38	36	0,6	41	38	1	46	42	1
30	6	43	42	0,6	48	45	1	54	50	1
35	7	51	48	1	55	52	1	62	58	1
40	8	57	55	1	63	60	1	70	65	1
45	9	62	60	1	69	65	1	78	72	1
50	10	67	62	1	77	72	1	86	80	1,5
55	11	76	72	1	85	80	1	94	88	1,5
60	12	81	78	1	90	85	1	102	95	1,5
65	13	86	82	1	95	90	1	110	100	2
70	14	91	88	1	103	98	1	118	110	2
75	15	96	92	1	111	105	1,5	126	115	2
80	16	101	98	1	116	110	1,5	134	125	2,1
85	17	109	105	1	124	115	1,5	142	130	2,1
90	18	117	110	1	129	120	1,5	150	140	2,1
100	20	130	125	1	142	135	1,5	166	155	2,5
110	22	140	135	1	158	150	2	182	170	2,5
120	24	150	145	1	174	165	2	195	185	3
130	26	166	160	1,5	187	177	2,1	214	200	3
140	28	176	170	1,5	200	190	2,1	-	-	-
150	30	189	180	1,5	210	200	2,1	-	-	-
160	32	199	190	1,5	-	-	-	-	-	-
170	34	212	200	1,5	-	-	-	-	-	-
180	36	222	210	1,5	-	-	-	-	-	-
190	38	238	230	1,5	-	-	-	-	-	-

Abutment and Fillet dimensions for Thrust Ball bearings of series 522, 523 and 524 [mm]

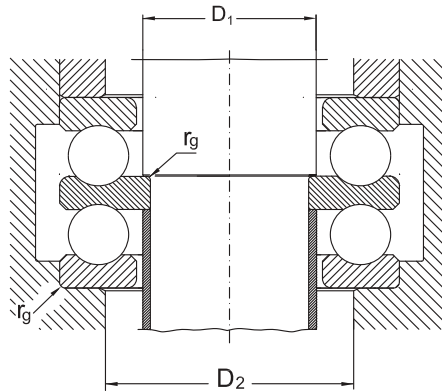

Shaft $\varnothing d_1$	Bore reference number	Bearing Series													
		522				523				524					
		D_1 min	D_2 min	r_g max	r_{g1} max	D_1 min	D_2 min	r_g max	r_{g1} max	Shaft	D_1 min	D_2 min	r_g max	r_{g1} max	
mm															
10	2	15	22	0,6	0,3	-	-	-	-	-	-	-	-	-	
15	4	20	28	0,6	0,3	-	-	-	-	-	-	-	-	-	
20	5	25	34	0,6	0,3	25	36	1	0,3	15	25	39	1	0,6	
25	6	30	39	0,6	0,3	30	42	1	0,3	20	30	46	1	0,6	
30	7	35	46	1	0,3	35	48	1	0,3	25	35	53	1	0,6	
30	8	40	51	1	0,6	40	55	1	0,6	30	40	60	1	0,6	
35	9	45	56	1	0,6	45	61	1	0,6	35	45	67	1	0,6	
40	10	50	61	1	0,6	50	68	1	0,6	40	50	74	1,5	0,6	
45	11	55	69	1	0,6	55	75	1	0,6	45	55	81	1,5	0,6	
50	12	60	74	1	0,6	60	80	1	0,6	50	60	88	1,5	0,6	
55	13	65	79	1	0,6	65	85	1	0,6	50	65	95	2	1	
55	14	70	84	1	1	70	92	1	1	55	70	102	2	1	
60	15	75	89	1	1	75	99	1,5	1	60	75	109	2	1	
65	16	80	94	1	1	80	104	1,5	1	65	80	116	2,1	1	
70	17	85	101	1	1	85	111	1,5	1	65	85	123	2,1	1	
75	18	90	108	1	1	90	116	1,5	1	70	90	130	2,1	1	
85	20	100	120	1	1	100	128	1,5	1	80	100	144	2,5	1	
95	22	110	130	1	1	110	142	2	1	-	-	-	-	-	
100	24	120	140	1	1	120	156	2,1	1	-	-	-	-	-	
110	26	130	154	1,5	1	130	168	2,1	1	-	-	-	-	-	
120	28	140	164	1,5	1	140	180	2,1	1	-	-	-	-	-	
130	30	150	176	1,5	1	150	190	2,1	1	-	-	-	-	-	
140	32	160	186	1,5	1	-	-	-	-	-	-	-	-	-	
150	34	170	198	1,5	1	-	-	-	-	-	-	-	-	-	

Abutment and Fillet dimensions for Thrust Ball bearings of series 542, 543 and 544 [mm]

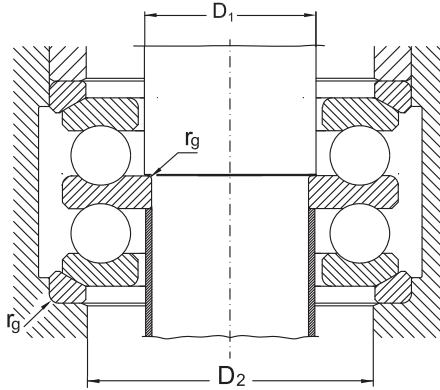

Shaft $\varnothing d_1$	Bore reference number	Bearing Series													
		542				543				Shaft	544				
		D_1 min	D_2 min	r_g max	r_{g1} max	D_1 min	D_2 min	r_g max	r_{g1} max		D_1 min	D_2 min	r_g max	r_{g1} max	
mm															
10	2	15	24	0,6	0,3	-	-	-	-	-	-	-	-	-	
15	4	20	30	0,6	0,3	-	-	-	-	-	-	-	-	-	
20	5	25	36	0,6	0,3	25	38	1	0,3	15	25	42	1	0,6	
25	6	30	42	0,6	0,3	30	45	1	0,3	20	30	50	1	0,6	
30	7	35	48	1	0,3	35	52	1	0,3	25	35	58	1	0,6	
30	8	40	55	1	0,6	40	60	1	0,6	30	40	65	1	0,6	
35	9	45	60	1	0,6	45	65	1	0,6	35	45	72	1	0,6	
40	10	50	62	1	0,6	50	72	1	0,6	40	50	80	1,5	0,6	
45	11	55	72	1	0,6	55	80	1	0,6	45	55	88	1,5	0,6	
50	12	60	78	1	0,6	60	85	1	0,6	50	60	95	1,5	0,6	
55	13	65	82	1	0,6	65	90	1	0,6	50	65	100	2	1	
55	14	70	88	1	1	70	98	1	1	55	70	110	2	1	
60	15	75	92	1	1	75	105	1,5	1	60	75	115	2	1	
65	16	80	98	1	1	80	110	1,5	1	65	80	125	2,1	1	
70	17	85	105	1	1	85	115	1,5	1	65	85	130	2,1	1	
75	18	90	110	1	1	90	120	1,5	1	70	90	140	2,1	1	
85	20	100	125	1	1	100	135	1,5	1	80	100	155	2,5	1	
95	22	110	135	1	1	110	150	2	1	-	-	-	-	-	
100	24	120	145	1	1	120	165	2,1	1	-	-	-	-	-	
110	26	130	160	1,5	1	-	-	-	-	-	-	-	-	-	

ART BEARINGS

Thrust Ball bearings, single direction

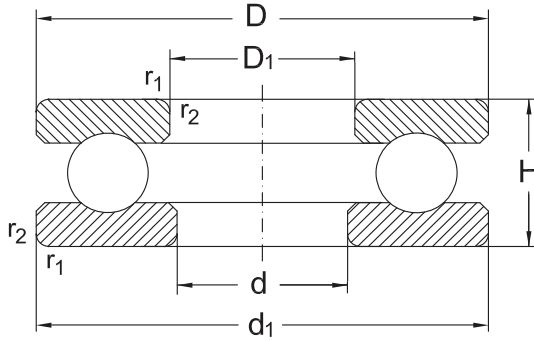

511/ 512/ 513/514

Shaft d	Dimension			Designation	Basical axial load		Speed limit	
	D	H	r_1, r_2 min.		dyn. C_a	stat. C_{0a}	grease	oil
	mm				kN		min ⁻¹	
10	24	9	0,3	51100	10	14	7000	9500
	26	11	0,6	51200	12,7	17,1	6000	8000
12	26	9	0,3	51101	10,4	15,4	6700	9000
	28	11	0,6	51201	13,2	19	6000	8000
15	28	9	0,3	51102	10,5	16,8	6300	8500
	32	11	0,6	51202	16,6	25	5000	6700
17	30	9	0,3	51103	10,8	18,2	6300	8500
	35	12	0,6	51203	17,3	27,5	5000	6700
20	35	10	0,3	51104	14,9	26,6	5300	7000
	40	14	0,6	51204	22,4	37,7	4300	5600
25	42	11	0,6	51105	15,6	30,4	4800	6300
	47	15	0,6	51205	28	50,5	3800	5000
	52	18	1	51305	35,4	61,5	3150	4200
	60	24	1	51405	56	90	2600	3600
30	47	11	0,6	51106	18,6	39,9	4300	5600
	52	16	0,6	51206	28,1	54,3	3600	4800
	60	21	1	51306	42,2	78,7	2900	3900
	70	28	1	51406	72	125	2200	3200
35	52	12	0,6	51107	19,1	44,4	4000	5300

Thrust Ball bearings, single direction

Shaft	Dimensions		Mass
d	d ₁	D ₁	Bearing
	mm		[kg]
10	24	11	0,02
	26	12	0,03
12	26	13	0,02
	28	14	0,03
15	28	16	0,02
	32	17	0,05
17	30	18	0,03
	35	19	0,05
20	35	21	0,04
	40	22	0,08
25	42	26	0,06
	47	27	0,12
	52	27	0,17
	60	27	0,36
30	47	32	0,07
	52	32	0,13
	60	32	0,26
	70	32	0,58
35	52	37	0,09

Thrust Ball bearings, single direction

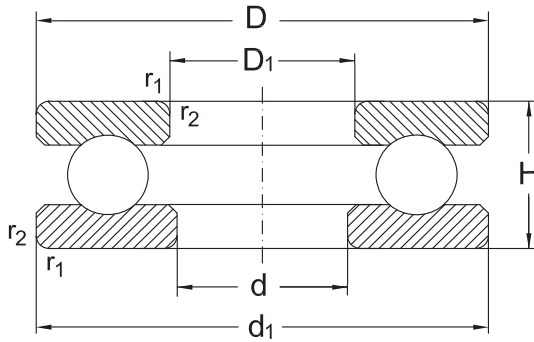

511/ 512/ 513/514

Shaft	Dimension			Designation	Basical axial load		Speed limit		
	d	D	H		r_1, r_2 min.	dyn. C_a	stat. C_{0a}	grease	oil
	mm				kN		min ⁻¹		
35	62	18	1	51207	38,8	78,2	3000	4000	
	68	24	1	51307	55,4	105	2600	3600	
	80	32	1,1	51407	86,5	156	2000	3000	
40	60	13	0,6	51108	26,8	62,9	3400	4500	
	68	19	1	51208	46,9	98,3	2800	3800	
	78	26	1	51308	68,4	135	2200	3200	
	90	36	1,1	51408	112	204	1700	2400	
45	65	14	0,6	51109	27,2	69,2	3400	4500	
	73	20	1	51209	49,3	112	2600	3600	
	85	28	1	51309	78,9	164	2000	3000	
	100	39	1,1	51409	140	262	1600	2200	
50	70	14	0,6	51110	28,1	75,5	3200	4300	
	78	22	1	51210	56,3	129	2400	3400	
	95	31	1,1	51310	95,3	202	1900	2800	
	110	43	1,5	51410	156	310	1500	2000	
55	78	16	0,6	51111	31,1	81,5	2800	3800	
	90	25	1	51211	68,8	159	2200	3200	
	105	35	1,1	51311	118	246	1700	2400	
	120	48	1,5	51411	180	360	1300	1800	

Thrust Ball bearings, single direction

Shaft	Dimensions		Mass
d	d_1	D_1	Bearing
	mm		[kg]
35	62	37	0,22
	68	37	0,38
	80	37	0,96
40	60	42	0,13
	68	42	0,28
	78	42	0,53
	90	42	1,17
45	65	47	0,15
	73	47	0,30
	85	47	0,61
	100	47	1,60
50	70	52	0,17
	78	52	0,37
	95	52	0,94
	110	52	2,18
55	78	57	0,25
	90	57	0,59
	105	57	1,30
	120	57	2,91

Thrust Ball bearings, single direction

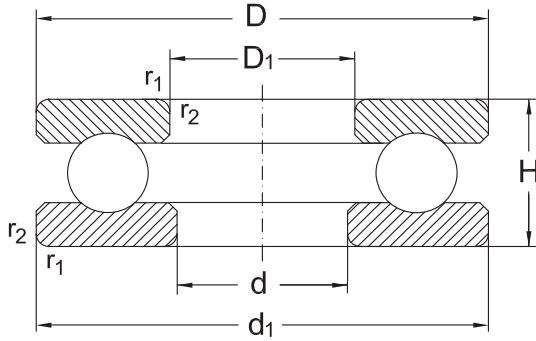

511/ 512/ 513/514

Shaft	Dimension			Designation	Basical axial load		Speed limit		
	d	D	H		r_1, r_2 min.	dyn. C_a	stat. C_{0a}	grease	oil
	mm				kN		min ⁻¹		
60	85	17	1	51112	37,9	98,6	2600	3600	
	95	26	1	51212	70,4	169	2000	3000	
	110	35	1,1	51312	123	267	1600	2200	
	130	51	1,5	51412 M	200	400	1200	1700	
65	90	18	1	51113	39,2	108	2400	3400	
	100	27	1	51213	78,5	191	2000	3000	
	115	36	1,1	51313	127	287	1600	2200	
	140	56	2	51413 M	216	450	1100	1600	
70	95	18	1	51114	39,3	113	2400	3400	
	105	27	1	51214	72,8	189	1900	2800	
	125	40	1,1	51314	153	341	1400	1900	
	150	60	2	51414 M	236	500	1100	1600	
75	100	19	1	51115	47,2	140	2200	3200	
	110	27	1	51215	73,7	199	1900	2800	
	135	44	1,5	51315	184	426	1300	1800	
	160	65	2	51415 M	250	560	1000	1500	
80	105	19	1	51116	48,5	145	2200	3200	
	115	28	1	51216	76,1	209	1800	2600	
	140	44	1,5	51316	181	426	1300	1800	
	170	68	2,1	51416 M	270	620	950	1400	

Thrust Ball bearings, single direction

Shaft	Dimensions		Mass
	d ₁	D ₁	Bearing
mm			[kg]
60	85	62	0,33
	95	62	0,65
	110	62	1,37
	130	62	3,70
65	90	67	0,36
	100	67	0,74
	115	67	1,49
	140	68	4,67
70	95	72	0,39
	105	72	0,78
	125	72	1,91
	150	73	5,72
75	100	77	0,52
	110	77	0,83
	135	77	2,61
	160	78	7,06
80	105	82	0,56
	115	82	0,91
	140	82	2,71
	170	83	8,23

Thrust Ball bearings, single direction

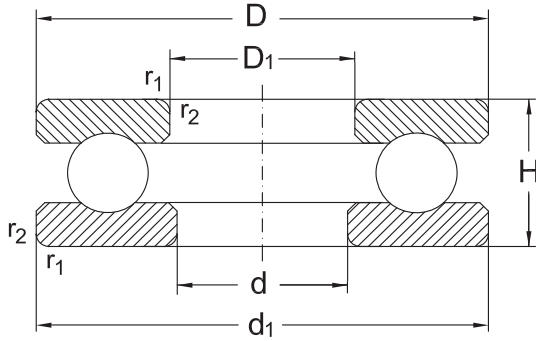

511/ 512/ 513/514

Shaft	Dimension			Designation	Basical axial load		Speed limit		
	d	D	H		r_1, r_2 min.	dyn. C_a	stat. C_{0a}	grease	oil
	mm				kN		min ⁻¹		
85	110	19	1	51117	48	151	2200	3200	
	125	31	1	51217	98	264	1600	2200	
	150	49	1,5	51317	290	716	1200	1700	
	180	72	2,1	51417 M	290	680	900	1300	
90	120	22	1	51118	62,3	190	1900	2800	
	135	35	1,1	51218	127	338	1500	2000	
	155	50	1,5	51318	196	465	1200	1700	
	190	77	2,1	51418 M	305	750	850	1200	
100	135	25	1	51120	85	270	1600	2200	
	150	38	1,1	51220	149	402	1400	1900	
	170	55	1,5	51320	247	628	1100	1600	
	210	85	3	51420 M	365	965	750	1000	
110	145	25	1	51122	86,5	290	1600	2200	
	160	38	1,1	51222	156	447	1300	1800	
	190	63	2	51322	319	869	950	1400	
	230	95	3	51422 M	415	1140	700	950	
120	155	25	1	51124	90	310	1500	2000	
	170	39	1,1	51224	170	509	1200	1700	
	210	70	2,1	51324	325	915	850	1200	
	250	102	4	51424 M	425	1220	670	900	

Thrust Ball bearings, single direction

Shaft	Dimensions		Mass
	d	d ₁	Bearing
mm			[kg]
85	110	87	0,60
	125	88	1,22
	150	88	3,53
	177	88	9,79
90	120	92	0,88
	135	93	1,68
	155	93	3,57
	187	93	11,60
100	135	102	1,30
	150	103	2,22
	170	103	4,95
	205	103	15,40
110	145	112	1,45
	160	113	2,41
	187	113	7,70
	225	113	20,80
120	155	122	1,59
	170	123	2,67
	205	123	10,70
	245	123	26,50

Thrust Ball bearings, single direction

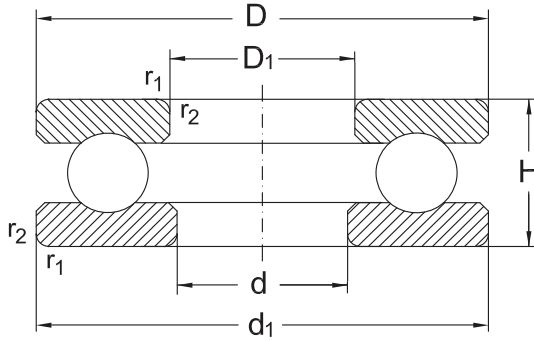

511/ 512/ 513/514

Shaft	Dimension			Designation	Basical axial load		Speed limit		
	d	D	H		r_1, r_2 min.	dyn. C_a	stat. C_{0a}	grease	oil
	mm				kN		min ⁻¹		
130	170	30	1	51126	117	392	1300	1800	
	190	45	1,5	51226	183	540	1100	1600	
	225	75	2,1	51326 M	360	1060	800	1100	
	270	110	4	51426 M	520	1600	600	800	
140	180	31	1	51128	112	400	1300	1800	
	200	46	1,5	51228	190	570	1000	1500	
	240	80	2,1	51328 M	400	1220	750	1000	
150	190	31	1	51130 M	110	400	1200	1700	
	215	50	1,5	51230 M	236	735	950	1400	
	250	80	2,1	51330 M	405	1290	700	950	
	300	120	4	51430 M	560	1800	560	750	
160	200	31	1	51132 M	112	430	1200	1700	
	225	51	1,5	51232 M	245	780	950	1400	
	270	87	3	51332M	479	1582	670	900	
170	215	34	1,1	51134 M	132	500	1100	1600	
	240	55	1,5	51234 M	285	930	850	1200	
	280	87	3	51334 M	496	1704	670	900	
180	225	34	1,1	51136 M	134	530	1000	1500	
	250	56	1,5	51236 M	290	1000	850	1200	
	300	95	3	51336 M	546	1956	600	800	

Thrust Ball bearings, single direction

Shaft	Dimensions		Mass
	d ₁	D ₁	Bearing
	mm		[kg]
130	170	132	2,37
	187	133	3,99
	220	134	13,00
	265	134	32,80
140	178	142	2,59
	197	143	4,33
	235	144	15,70
150	188	152	2,26
	212	153	6,09
	245	154	16,40
	295	154	43,10
160	198	162	2,39
	222	163	6,56
	265	164	21,30
170	213	172	3,08
	237	173	8,12
	275	174	22,50
180	222	183	3,17
	245	183	8,70
	295	184	28,3

Thrust Ball bearings, single direction

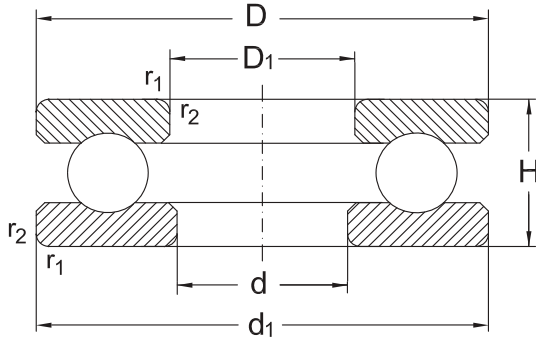

511/ 512/ 513/514

Shaft	Dimension			Designation	Basical axial load		Speed limit		
	d	D	H		r_1, r_2 min.	dyn. C_a	stat. C_{0a}	grease	oil
	mm				kN		min ⁻¹		
190	240	37	1,1	51138 M	170	655	950	1400	
	270	62	2	51238 M	335	1160	750	1000	
	320	105	4	51338 M	600	2200	560	750	
200	250	37	1,1	51140 M	170	655	950	1400	
	280	62	2	51240 M	340	1220	750	1000	
	340	110	4	51340 M	656	2414	530	700	
220	270	37	1,1	51144 M	176	735	850	1200	
	300	63	2	51244 M	355	1340	700	950	
240	300	45	1,5	51148 M	232	965	750	1000	
	340	78	2,1	51248 M	465	1860	600	800	
260	320	45	1,5	51152 M	236	1020	750	1000	
	360	79	2,1	51252 M	475	2000	560	750	
280	350	53	1,5	51156 M	315	1340	670	900	
	380	80	2,1	51256 M	490	2160	560	750	
300	380	62	2	51160 M	365	1600	600	800	
	420	95	3	51260 M	610	2750	480	630	
320	400	63	2	51164 M	375	1700	560	750	
	440	95	3	51264 M	620	2900	480	630	
340	420	64	2	51168 M	380	1800	560	750	
	460	96	3	51268 M	640	3150	450	600	

Thrust Ball bearings, single direction

Shaft	Dimensions		Mass
	d ₁	D ₁	Bearing
	mm		[kg]
190	237	193	4,08
	265	194	11,70
	315	195	35,70
200	245	203	4,26
	275	204	12,00
	335	205	44,30
220	265	223	4,64
	295	224	13,20
240	297	243	7,69
	335	244	23,00
260	317	263	8,25
	355	264	25,20
280	347	283	12,50
	375	284	26,70
300	376	304	17,70
	415	304	42,30
320	396	324	19,10
	435	325	44,20
340	416	344	20,50
	455	345	47,00

Thrust Ball bearings, single direction

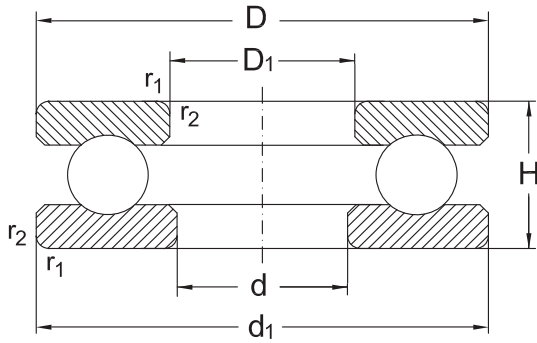

511/ 512/ 513/514

Shaft d	Dimension			Designation	Basical axial load		Speed limit	
	D	H	r_1, r_2 min.		dyn. C_a	stat. C_{0a}	grease	oil
	mm				kN		min ⁻¹	
360	440	65	2	51172 M	405	2000	530	700
	500	110	4	51272 M	765	3900	400	530
380	460	65	2	51176 M	430	2240	500	670
400	480	65	2	51180 M	440	2320	500	670
420	500	65	2	51184 M	440	2450	480	630
460	560	80	2,1	51192 M	530	3100	430	560
500	600	80	2,1	511/500 M	550	3350	400	530
530	640	85	3	511/530 M	620	3900	360	480
560	670	85	3	511/560 M	630	4150	300	380

Thrust Ball bearings, single direction

Shaft	Dimensions		Mass
d	d ₁	D ₁	Bearing
	mm		[kg]
360	436	364	21,50
	495	365	69,50
380	456	384	22,40
400	476	404	23,50
420	495	424	24,40
460	555	464	42,00
500	595	505	44,90
530	635	535	54,80
560	665	565	58,00

Thrust Ball bearings, double direction

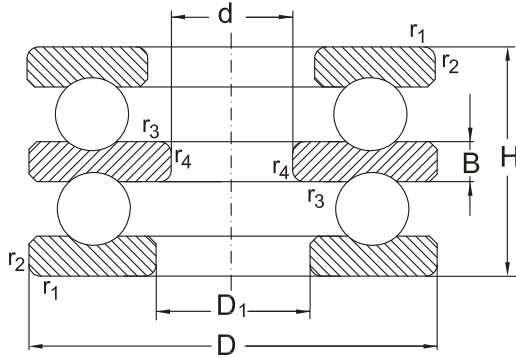

522/ 523/ 524

Shaft	Dimension				Designation	Basical axial load		Speed limit		
	d	D	H	r_1, r_2 min.		r_3, r_4 min.	dyn. C_a	stat. C_{0a}	grease	oil
	mm					kN		min ⁻¹		
10	32	22	0,6	0,3	52202	16,6	25	5000	6700	
15	40	26	0,6	0,3	52204	22,4	37,7	4300	5600	
	60	45	1	0,6	52205	56	90	2600	3600	
20	47	28	0,6	0,3	52205	28	50,4	3800	5000	
	52	34	1	0,3	52305	35,7	61,4	3200	4300	
	70	52	1	0,6	52406	72	125	2200	3200	
25	52	29	0,6	0,3	52206	28,1	54,3	3600	4800	
	60	38	1	0,3	52306	42,8	78,7	3000	4000	
	80	59	1,1	0,6	52407	86,5	156	2000	3000	
30	62	34	1	0,3	52207	40,7	83,8	3000	4000	
	68	36	1	0,6	52208	46,9	98,3	2800	3800	
	68	44	1	0,3	52307	55,5	105	2600	3600	
	78	49	1	0,6	52308	69,3	135	2200	3200	
	90	65	1,1	0,6	52408	112	204	1700	2400	
35	73	37	1	0,6	52209	47,7	105	2600	3600	
	85	52	1	0,6	52309	80,8	163	2000	3000	
	100	72	1,1	0,6	52409	129	245	1600	2200	
40	78	39	1	0,6	52210	50	111	2400	3400	
	95	58	1,1	0,6	52310	91,6	186	1900	2800	
	110	78	1,5	0,6	52410	156	310	1500	2000	

Thrust Ball bearings, double direction

Shaft	Dimensions		Mass
d	D1	B	Bearing
	mm		[kg]
10	17	5	0,08
15	22	6	0,15
	27	11	0,59
20	27	7	0,22
	27	8	0,32
	32	12	0,92
25	32	7	0,25
	32	9	0,47
	37	14	1,35
30	37	8	0,41
	42	9	55
	37	10	0,68
	42	12	1,01
	42	15	1,92
35	47	9	0,60
	47	12	1,25
	47	17	2,55
40	52	9	0,71
	52	14	1,77
	52	18	3,43

Thrust Ball bearings, double direction

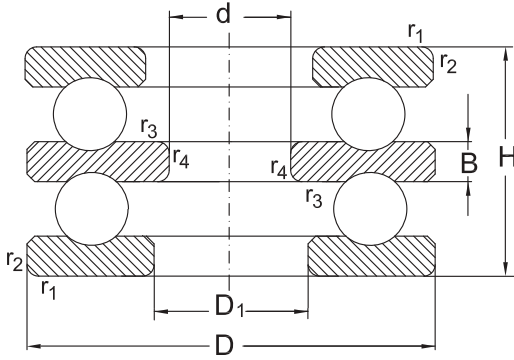

522/ 523/ 524

Shaft	Dimension				Designation	Basical axial load		Speed limit		
	d	D	H	r_1, r_2 min.		r_3, r_4 min.	dyn. C_a	stat. C_{0a}	grease	oil
	mm					kN		mn ⁻¹		
45	90	45	1	0,6	52211	69,4	159	2200	3200	
	105	64	1,1	0,6	52311	119	246	1700	2400	
	120	87	1,5	0,6	52411	180	360	1300	1800	
50	95	46	1	0,6	52212	73,6	179	2000	3000	
	110	64	1,1	0,6	52312	124	267	1600	2200	
	130	93	1,5	0,6	52412	200	400	1200	1700	
55	140	101	2	1	52413	216	450	1100	1600	
	100	47	1	0,6	52213	74,8	189	2000	3000	
	105	47	1	1	52214	73,6	189	1900	2800	
60	115	65	1,1	0,6	52313	106	220	1600	2200	
	125	72	1,1	1	52314	148	339	1400	1900	
	150	107	2	1	52414	236	500	1100	1600	
65	110	47	1	1	52215	77,4	209	1900	2800	
	135	79	1,5	1	52315	171	396	1300	1800	
	160	115	2	1	52415	250	560	1000	1500	
70	115	48	1	1	52216	78,5	218	1800	2600	
	140	79	1,5	1	52316	176	424	1300	1800	
	170	120	2	1	52416	270	620	950	1400	
	180	128	2,1	1,1	52417	290	680	900	1300	
70	125	55	1	1	52217	92,3	251	1600	2200	

Thrust Ball bearings, double direction

Shaft	Dimensions		Mass
d	D ₁	B	Bearing
	mm		[kg]
45	57	10	1,10
	57	15	2,38
	57	20	4,52
50	62	10	1,21
	62	15	2,53
	62	21	5,72
	68	23	7,18
55	67	10	1,34
	72	10	1,47
	67	15	2,73
	72	16	3,66
	73	24	8,76
60	77	10	1,57
	77	18	4,80
	78	26	10,80
65	82	10	1,72
	82	18	4,94
	83	27	12,70
	88	29	15,10
70	88	12	2,39

Thrust Ball bearings, double direction

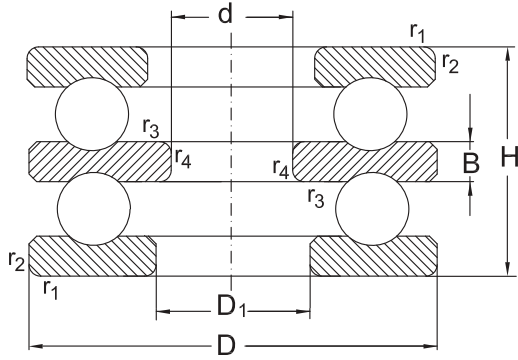

522/ 523/ 524

Shaft	Dimension				Designation	Basical axial load		Speed limit	
	d	D	H	r_1, r_2 min.		r_3, r_4 min.	dyn. C_a	stat. C_{0a}	grease
mm					kN		min ⁻¹		
70	150	87	1,5	1	52317	190	425	1200	1700
	190	135	2,1	1,1	52418	305	750	850	1200
75	135	62	1,1	1	52218	120	326	1500	2000
	155	88	1,5	1	52318	196	465	1200	1700
80	210	150	3	1,1	52420	365	965	750	1000
85	150	67	1,1	1	52220	147	410	1400	1900
	170	97	1,5	1	52320	236	596	1100	1600
95	160	67	1,1	1	52222	148	431	1300	1800
	190	110	2	1	52322 M	275	720	950	1400
100	170	68	1,1	1,1	52224	154	472	1200	1700
	210	123	2,1	1,1	52324 M	325	915	850	1200
110	190	80	1,5	1,1	52226	203	622	1100	1600
	225	130	2,1	1,1	52326 M	360	1060	800	1100
120	200	81	1,5	1,1	52228	190	570	1000	1500
	240	140	2,1	1,1	52328 M	400	1220	750	1000
130	215	89	1,5	1,1	52230 M	236	735	950	1400
140	225	90	1,5	1,1	52232 M	245	780	950	1400
150	240	97	1,5	1,1	52234 M	285	930	850	1200

Thrust Ball bearings, double direction

Shaft	Dimensions		Mass
d	D ₁	B	Bearing
	mm		[kg]
70	88	19	6,35
	88	30	17,80
75	93	14	3,22
	93	19	6,80
80	103	33	23,80
85	103	15	4,21
	103	21	8,94
95	113	15	4,63
	113	24	13,90
100	123	15	5,23
	123	27	19,40
110	133	18	7,99
	134	30	23,40
120	143	18	8,66
	144	31	28,20
130	153	20	11,40
140	163	20	12,10
150	173	21	14,90



Cylindrical Roller Thrust Bearings

Standards, Boundary dimensions

Standard plans	DIN 616
Cylindrical roller thrust bearings	DIN 722

General

Cylindrical Roller Thrust Bearings series 811 and 812 are single direction acting separable axial bearings.

Cylindrical roller thrust bearings are insensitive to shock loading and feature much higher load carrying capacity compared to thrust ball bearings. They accommodate very high axial loads but no radial forces. They provide a very rigid bearing assembly for high thrust loading with less space requirement.

Cylindrical roller thrust bearings are of simple design, they consist of a shaft washer (WS), a housing washer (GS), and a cylindrical roller and cage thrust assembly (K), see Abb. 1.

With all cylindrical roller thrust bearings, increased sliding friction can occur at the end of the cylindrical rollers.

In order to minimize this negative effect, ART cylindrical roller thrust bearings with wider sectional widths are produced using several short rollers in each cage pockets instead of using individual longer rollers.

Due to their specific kinematic behavior, cylindrical roller thrust bearings are only suitable for low speed applications only. Furthermore, they require minimal axial loads for their optimum function.

Design variants

ART cylindrical roller thrust bearings are produced in single direction design only as standard (see Abb. 1a)

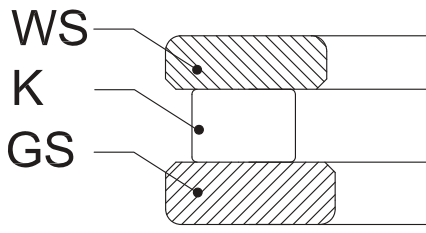

a

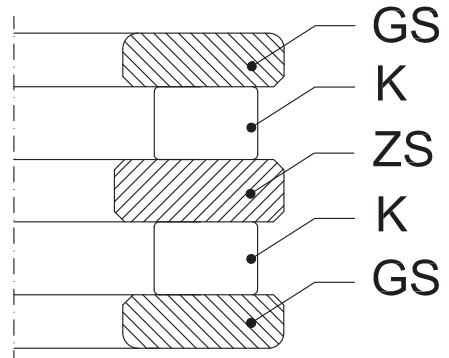

b

Double direction acting cylindrical roller thrust bearings are built using a combination of the components from single direction acting cylindrical roller thrust bearings together with intermediate washers ZS, (see Abb. 1 b).

Such intermediate washers are part of ART supplementary product range and are available on request. For application designs with space restrictions the cylindrical roller and cage thrust assemblies may be used without washers providing the contact faces of adjacent machine parts are machined as bearing raceways, (e.g. hardened and ground, etc.).

The components of cylindrical roller thrust bearing are frequently used either separately or in conjunction with other components in several applications (e.g. to build needle roller thrust assemblies) therefore, they are available as loose parts.

Misalignment

All cylindrical roller thrust bearing type do not allow any misalignment.

The contacting surfaces of both shaft and housing seats must be parallel.

Cages

Small ART cylindrical roller thrust bearings are fitted with shaft – centered polyamide cages as standard.

Polyamide cages are suitable for operating temperatures up to +120°C. Large cylindrical roller thrust bearings are produced with either solid brass cages (suffix MP), or with solid steel cages, (suffix FP).

Tolerances

ART cylindrical roller thrust bearings are produced to normal class tolerance (PN) as standard.

For applications of higher accuracy these bearings are produced to precision tolerance class (e.g. P6) on order request. For detailed values of the tolerance

classes see chapter “Bearing tolerances” (see page 39-40).

Minimum load:

All cylindrical roller thrust bearing require a certain minimum axial load to ensure a satisfactory operating function. To prevent excessive sliding friction, the minimum axial load applied should be greater than 5% of the axial bearing dynamic load rating C_a . Where such a minimum axial load is not possible the load must be increased by effective measures, (i.e. preloading the bearing) using pressure washers or springs.

Equivalent dynamic bearing load

Cylindrical roller thrust bearings are pure axial bearings; they are not able to accommodate any radial loads, therefore:

$$P = F_a$$

Equivalent static bearing load

For cylindrical roller thrust bearings:

$$P_0 = F_a$$

Design of adjacent machine parts

When cylindrical roller and cage thrust assemblies are used without washers, adjacent machines parts must be designed and machined as bearing raceways (e.g. hardened and ground etc.). The maximum permissible axial runout of the adjacent surfaces acting as raceway must also meet the requirements of the respective washers. The bore diameters of ART cylindrical roller and cage thrust assemblies have tolerances according to ISO Tolerance field (E11), whilst the tolerance of their outer diameters lies in the tolerance field (a13).

Cylindrical roller and cage thrust assemblies require an effective guidance when operating at

higher speeds.

To avoid excessive wear, at higher speeds, the guiding surface must be ground.

Bearing seats for cylindrical roller thrust bearings

For the design of cylindrical roller thrust bearing seats the following of tolerance fields have proven to be satisfactory in practice:

Centered at	Tolerance field	
	Shaft	Housing
Cylindrical roller and thrust assembly	h8	H9
Shaft washer	h6	-
Housing washer	-	H7

Abutment and Fillet dimensions for cylindrical roller thrust bearings

In case of cylindrical roller thrust bearings, an effective support of the bearing washers over the total width of their raceways by adjacent machine parts is necessary.

The bearing washer must contact adjacent parts with their side face only. The fillet radii of bearing corners must not touch the shoulder fillet radii of the shaft or housing shoulders.

Therefore, the largest fillet radius (r_f) must be smaller than the minimum fillet dimension of the bearing rings (r_g) as listed in the following tables.

Abutment and Fillet dimensions for cylindrical roller thrust bearings, series 811 and 812 [mm]

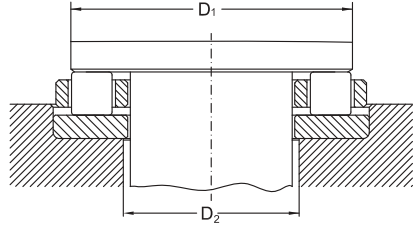
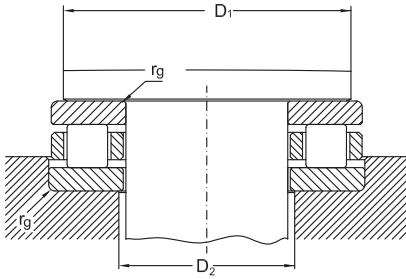

Shaft $\varnothing d$	Bore reference number	Bearing Series					
		811			812		
		D_1 min	D_2 min	r_g max	D_1 min	D_2 min	r_g max
mm							
15	2	25	18	0,3	-	-	-
17	3	27	20	0,3	-	-	-
20	4	32	23	0,3	-	-	-
25	5	39	28	0,6	-	-	-
30	6	44	33	0,6	49	33	0,6
35	7	49	38	0,6	56	41	1
40	8	56	44	0,6	63	45	1
45	9	61	49	0,6	68	50	1
50	10	66	54	0,6	73	55	1
55	11	73	60	0,6	84	61	1
60	12	80	65	1	89	66	1
65	13	85	70	1	94	71	1
70	14	90	75	1	99	76	1
75	15	95	80	1	104	81	1
80	16	100	85	1	109	86	1
85	17	105	90	1	117	93	1
90	18	114	96	1	127	98	1
100	20	129	106	1	140	110	1
110	22	139	116	1	150	120	1
120	24	149	126	1	160	130	1
130	26	162	138	1	179	141	1,5
140	28	172	148	1	189	151	1,5
150	30	182	158	1	204	161	1,5

Abutment and Fillet dimensions for cylindrical roller thrust bearings, series 811 and 812 [mm]

Shaft $\varnothing d$	Bore reference number	Bearing Series					
		811			812		
		D_1 min	D_2 min	r_g max	D_1 min	D_2 min	r_g max
mm							
160	32	192	168	1	214	171	1,5
170	34	207	178	1	227	183	1,5
180	36	217	188	1	237	193	1,5
190	38	230	200	1	256	204	2
200	40	240	210	1	266	214	2
220	44	260	230	1	286	234	2
240	48	288	252	1,5	322	258	2,1
260	52	308	272	1,5	342	278	2,1
280	56	337	293	1,5	362	298	2,1
300	60	365	315	2	398	322	2,5
320	64	385	335	2	418	342	2,5
340	68	405	355	2	438	362	2,5
360	72	425	375	2	475	385	3
380	76	445	395	2	495	405	3
400	80	465	415	2	515	425	3
420	84	485	435	2	552	448	4
440	88	522	458	2,1	572	468	4
460	92	542	478	2,1	592	488	4
480	96	562	498	2,1	621	509	4
500	/500	582	518	2,1	641	529	4
530	/530	619	551	2,5	680	560	4
560	/560	649	581	2,5	715	595	4
600	/600	689	621	2,5	764	636	4

Cylindrical Roller Thrust Bearings

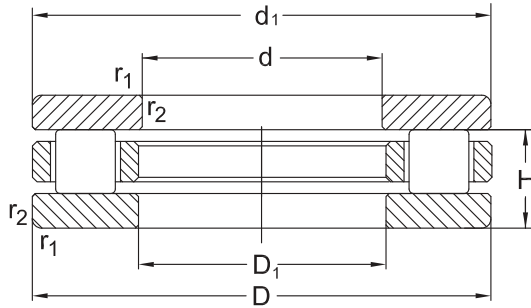

Dimension				Designation	Basical axial load		Speed limit	
d	D	H	r_1, r_2 min.		dyn. C_a	stat. C_{0a}	grease	oil
mm					kN		min^{-1}	
30	47	11	0,6	81106	28	83	2600	6700
	52	16	0,6	81206	50	132	2400	6300
35	52	12	0,6	81107	30	93	2200	6000
	62	18	1	81207	54	156	1900	5300
40	60	13	0,6	81108	42,5	137	1900	5300
	68	19	1	81208	76,5	220	1700	4800
45	65	14	0,6	81109	45	150	1700	4800
	73	20	1	81209	83	255	1600	4500
50	70	14	0,6	81110	42,5	143	1500	4300
	78	22	1	81210	88	285	1400	4000
55	78	16	0,6	81111	52	193	1400	4000
	90	25	1	81211	122	390	1200	3600
60	85	17	1	81112	73,5	265	1200	3600
	95	26	1	81212	114	335	1100	3400
65	90	18	1	81113	76,5	285	1100	3400
	100	27	1	81213	118	390	950	3000
70	95	18	1	81114	71	265	1000	3200
	105	27	1	81214	122	440	950	3000
75	100	19	1	81115	75	285	950	3000
	110	27	1	81215	125	440	900	2800
80	105	19	1	81116	76,5	300	900	2800
	115	28	1	81216	129	455	850	2600

Cylindrical Roller Thrust Bearings

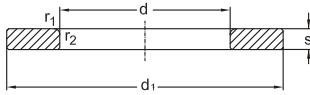

WS 8...

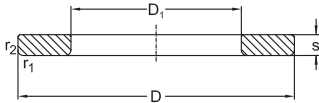

GS 8...

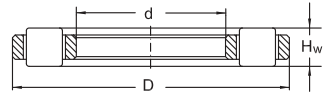

K 8...

Dimensions				Designation of Bearing Components			Mass
d	d ₁	D ₁	S	Cylindrical Roller and Cage thrust assembly	Shaft Washer	Housing Washer	
mm							[kg]
30	47	32	3	K81106	WS81106	GS81106	0,06
	52	32	4,25	K81206	WS81206	GS81206	0,13
35	52	37	3,5	K81107	WS81107	GS81107	0,08
	62	37	5,25	K81207	WS81207	GS81207	0,23
40	60	42	3,5	K81108	WS81108	GS81108	0,12
	68	42	5	K81208	WS81208	GS81208	0,27
45	65	47	4	K81109	WS81109	GS81109	0,14
	73	47	5,5	K81209	WS81209	GS81209	0,31
50	70	52	4	K81110	WS81110	GS81110	0,16
	78	52	6,5	K81210	WS81210	GS81210	0,38
55	78	57	5	K81111	WS81111	GS81111	0,23
	90	57	7	K81211	WS81211	GS81211	0,60
60	85	62	4,75	K81112	WS81112	GS81112	0,28
	95	62	7,5	K81212	WS81212	GS81212	0,74
65	90	67	5,25	K81113	WS81113	GS81113	0,33
	100	67	8	K81213	WS81213	GS81213	0,82
70	95	72	5,25	K81114	WS81114	GS81114	0,36
	105	72	8	K81214	WS81214	GS81214	0,87
75	100	77	5,75	K81115	WS81115	GS81115	0,43
	110	77	8	K81215	WS81215	GS81215	0,92
80	105	82	5,75	K81116	WS81116	GS81116	0,46
	115	82	8,5	K81216	WS81216	GS81216	1,02

Cylindrical Roller Thrust Bearings

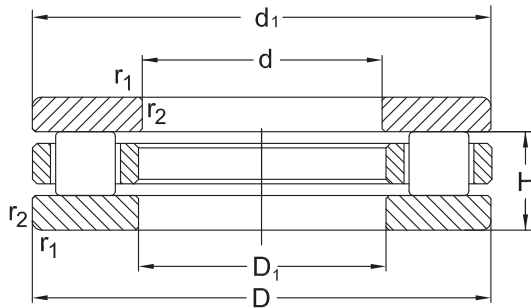

Dimension				Designation	Basical axial load		Speed limit	
d	D	H	r_1, r_2 min.		dyn. C_a	stat. C_{0a}	grease	oil
mm					kN		min^{-1}	
85	110	19	1	81117	76,5	310	850	2600
	125	31	1	81217	153	550	800	2400
90	120	22	1	81118	104	415	800	2400
	135	35	1,1	81218	190	670	800	2400
100	135	25	1	81120	146	585	750	2200
	150	38	1,1	81220	224	815	700	2000
110	145	25	1	81122	160	655	700	2000
	160	38	1,1	81222	232	865	670	1900
120	155	25	1	81124	160	680	670	1900
	170	39	1,1	81224	245	950	630	1800
130	170	30	1	81126	186	780	600	1700
	190	45	1,5	81226	365	1400	560	1600
140	180	31	1	81128	196	865	560	1600
	200	46	1,5	81228	375	1460	530	1500
150	190	31	1	81130	204	930	530	1500
	215	50	1,5	81230	455	1800	500	1400
160	200	31	1	81132	212	980	500	1400
	225	51	1,5	81232	465	1900	500	1400
170	215	34	1,1	81134	265	1220	500	1400
	240	55	1,5	81234	520	2080	480	1300
180	225	34	1,1	81136	275	1290	480	1300
	250	56	1,5	81236	520	2160	450	1200

Cylindrical Roller Thrust Bearings

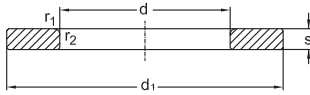

WS 8...

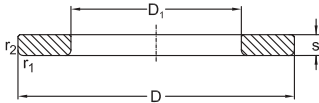

GS 8...

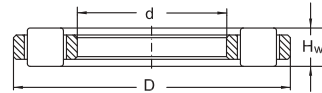

K 8...

Dimensions				Designation of Bearing Components			Mass
d	d ₁	D ₁	S	Cylindrical Roller and Cage thrust assembly	Shaft Washer	Housing Washer	
mm							[kg]
85	110	87	5,75	K81117	WS81117	GS81117	0,48
	125	88	9,5	K81217	WS81217	GS81217	1,36
90	120	92	6,5	K81118	WS81118	GS81118	0,72
	135	93	10,5	K81218	WS81218	GS81218	1,85
100	135	102	7	K81120	WS81120	GS81120	1,07
	150	103	11,5	K81220	WS81220	GS81220	2,45
110	145	112	7	K81122	WS81122	GS81122	1,12
	160	113	11,5	K81222	WS81222	GS81222	2,70
120	155	122	7	K81124	WS81124	GS81124	1,25
	170	123	12	K81224	WS81224	GS81224	2,98
130	170	132	9	K81126	WS81126	GS81126	1,72
	187	133	13	K81226	WS81226	GS81226	4,37
140	178	142	9,5	K81128	WS81128	GS81128	2,02
	197	143	13,5	K81228	WS81228	GS81228	4,76
150	188	152	9,5	K81130	WS81130	GS81130	2,15
	212	153	14,5	K81230	WS81230	GS81230	6,04
160	198	162	9,5	K81132	WS81132	GS81132	2,28
	222	163	15	K81232	WS81232	GS81232	6,52
170	213	172	10	K81134	WS81134	GS81134	3,01
	237	173	16,5	K81234	WS81234	GS81234	8,12
180	222	183	10	K81136	WS81136	GS81136	3,07
	247	183	17	K81236	WS81236	GS81236	8,69

Cylindrical Roller Thrust Bearings

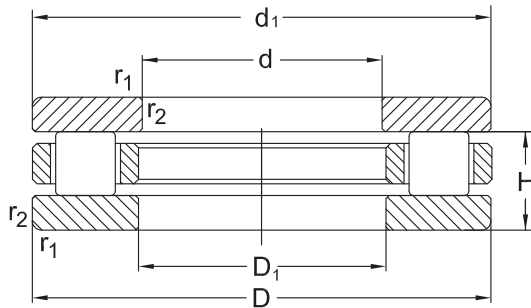

Dimension				Designation	Basical axial load		Speed limit	
d	D	H	r_1, r_2 min.		dyn. C_a	stat. C_{0a}	grease	oil
mm					kN		min^{-1}	
190	240	37	1,1	81138	315	1500	450	1200
	270	62	2	81238	655	2650	430	1100
200	250	37	1,1	81140	325	1600	450	1200
	280	62	2	81240	695	2900	430	1100
220	270	37	1,1	81144	355	1830	430	1100
	300	63	2	81244	735	3200	400	1000
240	300	45	1,5	81148	465	2360	380	950
	340	78	2,1	81248	980	4250	360	900
260	320	45	1,5	81152	500	2650	360	900
	360	79	2,1	81252	1040	4650	340	850
280	350	53	1,5	81156	670	3450	340	850
	380	80	2,1	81256	1060	4900	320	800
300	380	62	2	81160	800	4000	300	750
	420	95	3	81260	1400	6200	280	700
360	440	65	2	81172	900	4900	240	630
	500	110	4	81272	1960	9150	220	600
380	460	65	2	81176	880	4900	240	630
	520	112	4	81276	2000	9500	200	560

Cylindrical Roller Thrust Bearings

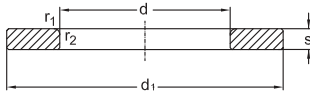

WS 8...

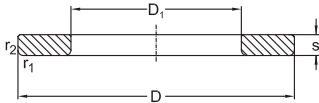

GS 8...

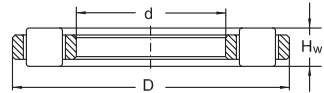

K 8...

Dimensions				Designation of Bearing Components			Mass
d	d ₁	D ₁	S	Cylindrical Roller and Cage thrust assembly	Shaft Washer	Housing Washer	
mm							[kg]
190	237	193	11	K81138	WS81138	GS81138	3,99
	267	194	18	K81238	WS81238	GS81238	11,70
200	247	203	11	K81140	WS81140	GS81140	4,17
	277	204	18	K81240	WS81240	GS81240	12,2
220	267	223	11	K81144	WS81144	GS81144	4,65
	297	224	18,5	K81244	WS81244	GS81244	13,4
240	297	243	13,5	K81148	WS81148	GS81148	7,43
	335	244	23	K81248	WS81248	GS81248	23,10
260	317	263	13,5	K81152	WS81152	GS81152	7,99
	355	264	23,5	K81252	WS81252	GS81252	25,1
280	347	283	15,5	K81156	WS81156	GS81156	12
	375	284	24	K81256	WS81256	GS81256	27,1
300	376	304	18,5	K81160	WS81160	GS81160	17,2
	415	304	28,5	K81260	WS81260	GS81260	42,50
360	436	364	20	K81172	WS81172	GS81172	21,4
	495	365	32,5	K81272	WS81272	GS81272	68,7
380	456	384	20	K81176	WS81176	GS81176	22,4
	515	385	33,5	K81276	WS81276	GS81276	73,3

Needle roller bearings



Needle roller bearings without inner ring

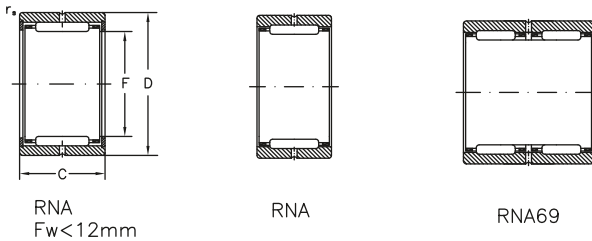

Dimensions				Basic radial load		Speed limit		Designation	Mass
F_w	D	C	r_s min.	dyn. C_r	stat. C_{or}	grease	oil		
mm				kN		min ⁻¹		-	Kg
8	15	12	0,3	3,7	3,95	19000	32000	RNA081512	0,008
	15	16	0,3	4,95	5,65	19000	32000	RNA081516	0,012
9	16	12	0,3	4,3	4,8	18000	30000	RNA091612	0,010
	16	16	0,3	5,6	6,9	18000	30000	RNA091616	0,013
10	17	12	0,3	4,5	5,35	17000	28000	RNA101712	0,011
	17	16	0,3	5,8	6,5	17000	28000	RNA101716	0,014
12	18	15	0,3	5,6	7,75	16000	26000	RNA121815 TN	0,012
	19	12	0,3	4,65	5,8	16000	26000	RNA121912	0,013
	19	16	0,3	6,15	8,1	16000	26000	RNA121916	0,017
	22	12	0,3	5,3	6,65	16000	26000	RNA122212	0,021

Needle roller bearings without inner ring

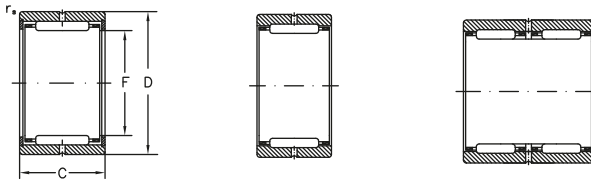

RNA
F_w < 12mm

RNA

RNA69

Dimensions				Basic radial load dyn. C _r	Speed limit grease oil min ⁻¹	Designation	Mass Kg		
F _w	D	C	r _s min.						
mm				kN		-			
14	22	13	0,3	8,25	9,1	15000	24000	RNA4900	0,017
	22	16	0,3	9,8	11,3	15000	24000	RNA142216	0,021
	22	20	0,3	11,8	15,4	15000	24000	RNA142220	0,028
16	24	13	0,3	9,1	10,6	15000	24000	RNA4901	0,018
	24	22	0,3	14,8	20,2	15000	24000	RNA6901	0,032
18	28	15	0,3	9,5	11,9	14000	22000	RNA182815	0,036
20	28	13	0,3	10,4	13,2	13000	20000	RNA4902	0,022
	28	23	0,3	16,8	24,5	13000	20000	RNA6902	0,040
22	30	13	0,3	10,7	13,9	11000	18000	RNA4903	0,023
	30	23	0,3	18,2	27,8	11000	18000	RNA6903	0,043
25	37	17	0,3	20	24,4	9500	16000	RNA4904	0,053
	37	30	0,3	33	47,6	9500	16000	RNA6904	0,101
30	40	20	0,3	21	33	8000	13000	RNA304020	0,065
	42	17	0,3	22,2	28,3	8000	13000	RNA4905	0,068
	42	30	0,3	40,1	60,1	8000	13000	RNA6905	0,155
35	45	20	0,3	24,2	38,5	7000	11000	RNA354520	0,074
	47	17	0,3	23,7	32,1	7000	11000	RNA4906	0,140
	47	30	0,3	43,1	49,3	7000	11000	RNA6906	0,131
38	48	20	0,3	24,3	41,4	7000	11000	RNA384820	0,080
42	55	20	0,6	29,8	45,5	6300	9500	RNA4907	0,109
	55	36	0,6	52,7	95	6300	9500	RNA6907	0,214
45	55	30	0,3	40,2	86,9	6000	9000	RNA455530	0,137
48	62	22	0,6	38,7	60,9	5600	8500	RNA4908	0,147
	62	40	0,6	63,8	116	5600	8500	RNA6908	0,266
50	62	22	1	35,5	60,3	5300	8000	RNA506222	0,153
	62	25	0,6	36,3	76	5300	8000	RNA506225	0,157
	62	35	0,6	49,4	114	5300	8000	RNA506235	0,209
52	68	22	0,6	46,4	73,9	5000	7500	RNA4909	0,197
	68	40	0,6	64,5	123	5000	7500	RNA6909	0,283
55	68	25	0,6	38,5	82,2	5000	7500	RNA556825 TN	0,181
58	72	22	0,6	45	73,5	4800	7000	RNA4910	0,167
	72	40	0,6	67,3	136	4800	7000	RNA6910	0,335
60	72	25	0,6	40,2	87	4500	6700	RNA607225 TN	0,160
	72	35	0,6	55,7	130	4500	6700	RNA607235	0,224

Needle roller bearings without inner ring

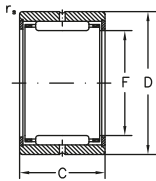

RNA
F_w < 12mm



RNA

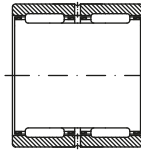

RNA69

Dimensions				Basic radial load		Speed limit		Designation	Mass
F _w	D	C	r _s min.	dyn. C _r	stat. C _{0r}	grease	oil		
mm				kN		min ⁻¹		-	Kg
63	80	25	0,6	59,3	101	4500	6700	RNA4911	0,278
	80	45	0,6	83,8	173	4500	6700	RNA6911	0,477
68	85	25	1	62	109	4000	6000	RNA4912	0,296
	85	45	1	89,1	175	4000	6000	RNA6912	0,493
72	90	25	1	58,3	110	3800	5600	RNA4913	0,318
	90	45	1	91,3	193	3800	5600	RNA6913	0,545
80	95	25	1	53,4	115	3400	5000	RNA809525	0,312
	100	30	1	76,5	148	3400	5000	RNA4914 TN	0,485
	100	54	1	125	254	3400	5000	RNA6914	0,545
85	105	30	1	80,6	158	3200	4800	RNA4915	0,504
	105	54	1	127	270	3200	4800	RNA6915	0,965
90	110	30	1	84,9	169	3000	4500	RNA4916	0,520
	110	54	1	144	316	3000	4500	RNA6916	0,973
95	115	26	1	74,3	137	2800	4300	RNA95/26	0,523
100	120	35	1,1	98,8	222	2600	4000	RNA4917	0,672
	120	63	1,1	143	378	2600	4000	RNA6917	1,24
105	125	35	1,1	110	222	2400	3800	RNA4918	0,712
	125	63	1,1	144	400	2400	3800	RNA6918	1,36
110	130	30	1,1	99,6	210	2200	3600	RNA110/30	0,629
	130	35	1,1	105	244	2200	3600	RNA4919	0,729
	130	63	1,1	149	411	2200	3600	RNA6919	1,48
115	140	40	1,1	124	267	2200	3600	RNA4920	1,17
120	140	30	1	102	222	2000	3400	RNA4822	0,729
125	150	40	1,1	127	283	2000	3400	RNA4922	1,25
130	150	30	1	86,8	228	1800	3000	RNA4824	0,730
135	165	45	1,1	170	385	1800	3000	RNA4924	1,93
145	165	35	1,1	122	316	1700	2800	RNA4826	1,02
150	180	50	1,5	188	421	1700	2800	RNA4926	2,25
155	175	35	1,1	128	323	1600	2600	RNA4828	1,21
	180	32	1,5	116	258	1600	2600	RNA155/32	1,22
160	190	50	1,5	190	484	1600	2600	RNA4928	2,50
165	190	40	1,1	150	386	1500	2400	RNA4830	1,68

Needle roller bearings

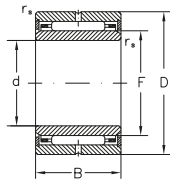

NA
d < 9 mm

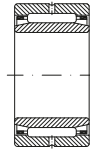

NA

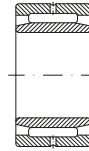

NAV

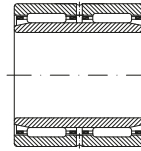

NA69

Dimensions					Basic radial load		Speed limit		Designation	Mass
d	D	B	r _s min.	F _w	dyn. C _r	stat. C _{0r}	grease	oil		
mm					kN		min ⁻¹		-	Kg
5	15	12	0,3	8	3,7	3,95	19000	32000	NA051512	0,013
	15	16	0,3	8	4,95	5,65	19000	32000	NA051516	0,016
6	16	12	0,3	9	4,3	4,8	18000	30000	NA061612	0,014
	16	16	0,3	9	5,6	6,9	18000	30000	NA061616	0,018
7	17	12	0,3	10	4,5	5,35	17000	28000	NA071712	0,015
	17	16	0,3	10	5,8	6,5	17000	28000	NA071716	0,020
9	19	12	0,3	12	4,65	5,8	16000	26000	NA091912	0,018
	19	16	0,3	12	6,15	8,1	16000	26000	NA091916	0,023
10	22	13	0,3	14	8,25	9,1	15000	24000	NA4900	0,024
	22	16	0,3	14	9,8	11,3	15000	24000	NA102216	0,031
	22	20	0,3	14	11,8	15,4	15000	24000	NA102220	0,038
12	24	13	0,3	16	9,1	10,6	15000	24000	NA4901	0,027
	24	22	0,3	16	14,8	20,2	15000	24000	NA6901	0,048
15	28	13	0,3	20	10,4	13,2	13000	20000	NA4902	0,035
	28	23	0,3	20	16,8	24,5	13000	20000	NA6902	0,065
17	30	13	0,3	22	10,7	13,9	11000	18000	NA4903	0,039
	30	23	0,3	22	18,2	27,8	11000	18000	NA6903	0,074
20	37	17	0,3	25	20,6	24,4	9500	16000	NA4904	0,077
	37	30	0,3	25	33	47,6	9500	16000	NA6904	0,143
25	42	17	0,3	30	22,2	28,3	8000	13000	NA4905	0,096
	42	17	0,3	30	30	42,8	3000	6000	NA4905 V	0,100
	42	30	0,3	30	40,1	60,1	8000	13000	NA6905	0,170
30	45	20	0,3	35	24,2	38,5	7000	11000	NA304520	0,117
	47	17	0,3	35	23,7	32,1	7000	11000	NA4906	0,107
	47	30	0,3	35	43,1	69,3	7000	11000	NA6906	0,202
35	55	20	0,6	42	29,8	45,5	6300	9500	NA4907	0,174
	55	36	0,6	42	52,7	95	6300	9500	NA6907	0,330
40	55	30	0,3	45	40,2	86,9	6000	9000	NA405530	0,221
	62	22	0,6	48	38,7	60,9	5600	8500	NA4908	0,239
	62	22	0,6	48	55	97,1	2000	4000	NA4908 V	0,266
	62	40	0,6	48	63,8	116	5600	8500	NA6908	0,450
	65	22	1	50	40,7	66,9	5600	8500	NA406522	0,290
45	62	25	0,6	50	36,3	76	5300	8000	NA456225	0,235
	62	35	0,6	50	49,4	114	5300	8000	NA456235	0,330
	62	22	0,6	52	46,4	73,9	5000	7500	NA4909	0,285
	68	40	0,6	52	64,5	123	5000	7500	NA6909	0,515
50	68	25	0,6	55	38,5	82,2	5000	7500	NA506825 TN	0,268
	72	22	0,6	58	45	73,5	4800	7000	NA4910	0,280
	72	40	0,6	58	67,3	136	4800	7000	NA6910	0,545

Needle roller bearings

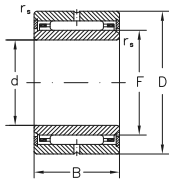

NA
d < 9 mm

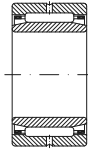

NA

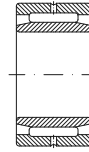

NAV

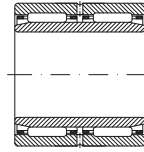

NA69

Dimensions				Basic radial load		Speed limit		Designation	Mass	
d	D	B	r _s min.	F _w	dyn. C _r	stat. C _{0r}	grease oil	-	Kg	
mm										
55	72	25	0,6	60	40,2	87	4500	6700	NA557225 TN	0,283
	72	35	0,6	60	55,7	130	4500	6700	NA557235	0,380
	80	25	1	63	59,3	101	4500	6700	NA4911	0,423
	80	25	1	63	80,3	151	1500	3000	NA4911 V	0,448
	80	45	1	63	83,3	173	4500	6700	NA6911	0,795
60	85	25	1	68	62	109	4000	6000	NA4912	0,454
	85	25	1	68	83,4	163	1400	2800	NA4912 V	0,480
	85	45	1	68	89,1	175	4000	6000	NA6912	0,836
65	90	25	1	72	58,3	110	3800	5600	NA4913	0,472
	90	45	1	72	91,3	193	3800	5600	NA6913	0,881
70	95	25	1	80	53,4	115	3400	5000	NA709525	0,538
	100	30	1	80	76,5	148	3400	5000	NA4914 TN	0,725
	100	30	1	80	103	231	1200	2700	NA4914 V	0,774
	100	54	1	80	125	254	3400	5000	NA6914	1,39
75	105	30	1	85	80,6	80,6	3200	4800	NA4915	0,796
	105	54	1	85	127	127	3200	4800	NA6915	1,51
80	110	30	1	90	84,9	84,9	3000	4500	NA4916	0,870
	110	54	1	90	144	144	3000	4500	NA6916	1,48
85	115	26	1	95	74,3	74,3	2800	4300	NA85/26	0,830
	120	35	1,1	100	98,8	98,8	2600	4000	NA4917	1,28
	120	63	1,1	100	143	143	2600	4000	NA6917	2,33
	130	45	1,1	104	121	121	900	1800	NA4617 V	2,57
90	125	35	1,1	105	110	110	2400	3800	NA4918	1,34
	125	63	1,1	105	144	144	2400	3800	NA6918	2,47
95	130	35	1,1	110	105	105	2200	3600	NA4919	1,39
	130	63	1,1	110	149	149	2200	3600	NA6919	2,63
100	130	30	1,1	110	99,6	99,6	2200	3600	NA100/30	1,00
	140	40	1,1	115	174	124	2200	3600	NA4920	1,93
110	140	30	1	120	102	102	2000	3400	NA4822	1,15
	150	40	1,1	125	127	127	2000	3400	NA4922	2,09
120	150	30	1	130	86,8	86,8	1800	3000	NA4824	1,23
	165	45	1,1	135	170	170	1800	3000	NA4924	2,95
130	165	35	1,1	145	122	122	1700	2800	NA4826	1,90
	180	50	1,5	150	188	188	1700	2800	NA4926	3,98
140	175	35	1,1	155	128	128	1600	2600	NA4828	1,99
	180	32	1,5	155	116	116	1600	2600	NA140/32	2,05
	190	50	1,5	160	190	190	1600	2600	NA4928	4,32
150	190	40	1,1	165	150	150	1500	2400	NA4830	2,85





Spherical plain bearings

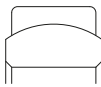
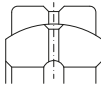
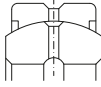

Rod ends

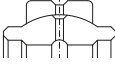
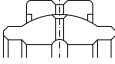

Spherical plain bearings and rod ends URB are manufactured with material of the best quality on machines of high precision, therefore we are able to guarantee that they are products of high quality, suitable to a many lot of uses in sector of industry, farming, hydraulics, pneumatics and everywhere

it is requested a precision use, or hard loads, or maintenance free. The tolerances of manufacture and assembly respect the rules of standard ISO (and DIN for some series used for hydraulics) and they ae interchangeable with products of the most important manufactures.

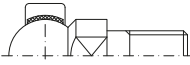
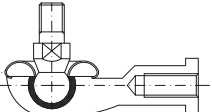

Name and number	Equivalent			Bore diameter range (mm)	Design feature
	SKF	INA	IKO		
 <p>Spherical plain radial bearings with fitting crack GE...E GEG...E</p>	page 566 GE...E	GE...DO GE...FO	GE...E GE...G	4-12 4-12	Outer ring without single split in axial direction. No lubrication grooves and holes, both outer and inner rings are properly phosphorlylate-treated
 <p>Spherical plain radial bearings with fitting crack GE...ES GEG...ES</p>	page 568 GE...ES GEH...ES	GE...DO GE...FO	GE...ES GE...GS	15-3000 15-280	Outer ring with single split in axial direction. Lubrication grooves and holes in the outer and inner rings. Both outer and inner rings are properly phosphorlylate-treated
 <p>Spherical plain radial bearings with two seals and fitting crack GE...ES 2RS GEG...ES 2RS</p>	page 569 GE...ES 2RS GEH...ES 2RS	GE...DO 2RS GE...FO 2RS	GE...ES 2RS GE...GS 2RS	15-300 15-280	Outer ring with single split in axial direction. With two seals. Lubrication grooves and holes in the outer and inner rings. Both outer and inner rings are properly phosphorlylate-treated

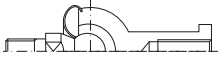
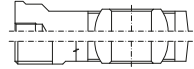
Name and number	Equivalent			Bore diameter range (mm)	Design feature
	SKF	INA	IKO		
 <p>page 570</p> <p>Spherical plain radial bearings with wide inner ring and fitting crack. GEEW...ES</p>	GEG...ES	GE...LO	-	12-100	Outer ring with single split in axial direction. Inner ring with cylindrical extension at either side. Lubrication grooves and holes in the outer and inner rings. Both outer and inner rings are properly phosphorlylate-treated.
 <p>page 571</p> <p>Spherical plain radial bearings with two seals and wide inner ring and fitting crack GEEW...ES 2RS GEEW...ES 2RS</p>	GEM...ES 2RS	GE...HO 2RS	-	20-80 12-100	Outer ring with single split in axial direction. With two seals. Inner ring with cylindrical extension at either side. Lubrication grooves and holes in the outer and inner rings. Both outer and inner rings are properly phosphorlylate-treated
 <p>page 572</p> <p>Maintenance-free spherical plain radial bearings GE...E GE...ET 2RS GEG...C GEG...ET 2RS</p>	GE...C GE...TE 2RS GEH...C GEH...C 2RS	GE...UK GE...UK 2RS GE...FW GE...FW 2RS	GE...EC GE...EL 2RS	4-30 20-140 4-30 30-140	Outer ring pressed around inner ring. To line SF1 material on the surface of spherical plain. Spherical surface of inner ring with chromium plating.
 <p>page 575</p> <p>Angular contact spherical plain bearings GAC...S</p>	GAC...F	GE...SW	-	25-120	Separable outer and inner rings. Lubrication grooves and holes in the outer and inner rings. Both outer and inner rings are properly phosphorlylate-treated.
 <p>page 576</p> <p>Spherical plain thrust bearings GX...S</p>	GX...F	GE...AW	-	10-120	Separable shaft and housing washers. Lubrication grooves and holes in the housing washer. Both shaft and housing washer are properly phosphorlylate-treated.

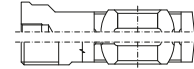
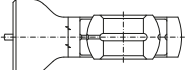
Name and number	Equivalent			Bore diameter range (mm)	Design feature
	SKF	INA	IKO		
 <p>page 577</p> <p>Spherical plain radial bearings with fitting crack. Dimensions in inches. GEZ...ES GEZ...ES 2RS</p>	GEZ...ES GEZ...ES 2RS	GE...ZO GE...ZO 2RS	SBB... SBB...2RS	12,7-152,4 12,7-152,4	As type GE...ES, but dimensions in inches.
 <p>page 579</p> <p>Spherical plain radial bearings with two pieces. GE...XS K</p>	-	-	SB...	12-150	Outer ring with two pieces in axial direction. Lubrication grooves and holes in the outer and inner rings. Both outer and inner rings are properly phosphorlylate-treated
 <p>page 581</p> <p>Spherical plain radial bearings with two seals, two pieces. GEK...XS 2RS</p>	-	-	-	25-60	Outer ring with two axial pieces and two seals. Spherical surface of inner ring with cromium plating. Lubrication grooves and holes in the outer and inner rings.
 <p>page 582</p> <p>Ball joint rod ends with one shank. SQD...C</p>	-	-	-	5-16	Ball joint housing is an outer ring of spherical plain radial bearing. To line SF1 material on the surface of spherical plain.
 <p>page 583</p> <p>Winding shape ball joint rod ends with a dust cover. SQ...C RS</p>	-	-	-	5-22	Ball joint housing is a "L" shaped shank with dust cover with female tread. They are available for right or left hand thread. To line SF1 material on the surface of spherical plain.

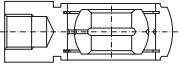
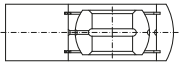
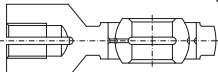
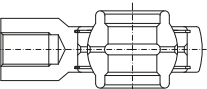
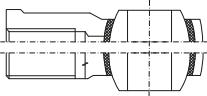
Name and number	Equivalent			Bore diameter range (mm)	Design feature
	SKF	INA	IKO		
 <p>page 585</p> <p>Straight ball joint rod ends with a dust cover. SQZ...C RS</p>	-	-	-	5-22	Ball joint housing is an axial shank with dust cover with femal thread. Stretching rod with right or left hand thread. To line SF1 material on the surface of spherical plain.
 <p>pages 587, 592</p> <p>Combination rod ends SI...E SA...E</p>	SI...E SA...E	GIR...DO GAR...DO	- -	5-12 5-12	Bearings with a stretching rod. Stretching rod with right or left-hand, male or female thread. It is made up of a spherical plain radial bearing of type GE...E and rod body.
 <p>pages 587, 592</p> <p>Combination rod ends SI...ES SA...ES SI...ES 2RS SA...ES 2RS</p>	SI...ES/SIA...ES SA...ES/SIA...ES - -	GIR...DO GAR...DO GIR...DO 2RS GAR...DO 2RS	- - - -	15-80 15-80 15-80 15-80	Bearings with a stretching rod. Stretching rod with right or left-hand, male or female thread. It is made up of a spherical plain radial bearing of type GE...ES and rod body. The housing with a lubrication hole or a grease nipple.
 <p>pages 587, 592</p> <p>Combination rod ends SI...C SA...C SI...C 2RS SA...C 2RS</p>	SI...C SA...C SI...TE 2RS SA...TE 2RS	GIR...UK GAR...UK GIR...UK 2RS GAR...UK 2RS	- - - -	15-80 15-80 35-80 35-80	Bearings with a stretching rod. Stretching rod with right or left-hand, male or female thread. It is made up of a spherical plain radial bearing of type GE...ES and rod body. To line SF1 material on the surface of spherical plain.
 <p>page 593</p> <p>Ball joint ends for hydraulics with grease nipple, welding steel body TAC</p>		GK...DO	-	10-18	Round bal joint ends to weld on the bottom of cylinder. Standard dimensions DIN 648. Sliding contact surface: steel/steel

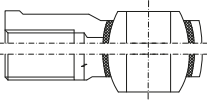
Name and number	Equivalent			Bore diameter range (mm)	Design feature
	SKF	INA	IKO		
 <p>page 594</p> <p>Screwed ball joint ends for hydraulics also with screw clamping device and grease nipple TAPR...N</p>	SIR...ES	GIHR...DO GIHRK...DO	- -	20-120 20-120	Screwed ball joint ends with screw on shank and also with body equipped of clamping screws in hard execution. Sliding contact surface: steel/steel
 <p>page 596</p> <p>Ball joint ends for hydraulics with grease nipple, welding steel body TPN</p>	SCF...ES	GF...DO	-	2020	Ball joint ends in strong execution to weld advisable with alternate loads. Sliding contact surface: steel/steel
 <p>page 597</p> <p>Screw on ball joint ends for hydraulics with screw clamping device and grease nipple TAPR...DO</p>	SIJ...ES	GIHO-K...DO	-	12-100	Ball joint ends with internal thread and clamping device through two screws on two sides Standard DIN 24555. Sliding contact surface: steel/steel
 <p>page 598</p> <p>Screw on ball joint ends for hydraulics with screw clamping device and grease nipple TAPR...CE</p>	SIQG...ES	GIHN-K...LO	-	12-125	Stout ball joint ends with internal thread. Standard DIN 24338 with screws clamping device sliding contact surface: steel/steel
 <p>pages 599, 600</p> <p>Rod ends POS... PHS...</p>	SAKAC...M SIKAC...M	GAKFR...PB GIKFR...PB	POS... PHS...	5-30 5-30	Bearings with a stretching rod. Stretching rod with right or left-hand, male or female thread. To line bronze material on the surface of spherical plain. Spherical surface of ball with chromium plating.

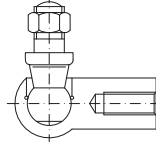
Name and number	Equivalent			Bore diameter range (mm)	Design feature
	SKF	INA	IKO		
 <p>Maitanance-free rod POS...EC_ PHS...EC</p>	page 600 SAKB...F SIKB...F	GAKFR...PW GIKFR...PW	POS...EC PHS...EC	5-30 5-30	Bearings with a stretching rod with right or left-hand, male or female thread. To line SF1 material on the surface of spherical plain. Spherical surface of ball with chromium plating.
 <p>Spherical plain radial bearings SSR</p>	page 601 -	-	- -	5-30	Outer ring with single split in axial direction. Lubrication grooves and holes in the outer rings. Sliding contact surfaces: bronze/steel.
 <p>Ball joints rod ends DIN 71802</p>	page 602 -	-	- - - -	8-19	Ball joints rod ends with shank and spring clamping.

Spherical plain radial bearings with fitting crack

Two seals and fitting crack, fitting groove

ISO 6124-1979, ISO 6125-1979

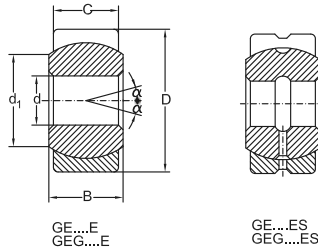

Dimensions				Load ratings				Designation	Mass
d	D	B	C	d ₁ min	dyn.	stat.	α^*		
mm					kN	kN		-	kg
4	12	5	3	6	2	10	16	GE4 E	0,0033
5	14	6	4	7	3,4	17	13	GE5 S	0,0038
6	14	6	4	8	3,4	17	13	GE6 S	0,0042
8	16	8	5	10	5,5	27	15	GE8 S	0,0075
10	19	9	6	13	8,1	40	12	GE10 E	0,011
12	22	10	7	15	10	54	10	GE12 E	0,015
15	26	12	9	18	17	85	8	GE15 E	0,027
	26	12	9	18	17	85	8	GE15 ES-2RS	0,027
17	30	14	10	20	21	106	10	GE17 ES	0,041
	30	14	10	20	21	106	10	GE17 ES-RS	0,041
20	35	16	12	24	30	146	9	GE20 ES	0,066
	35	16	12	24	30	146	9	GE20 ES-2RS	0,066
25	42	20	16	29	48	240	7	GE25 ES	0,119
	42	20	16	29	48	240	7	GE25 ES-2RS	0,119
30	47	22	18	34	62	310	6	GE30 ES	0,153
	47	22	18	34	62	310	6	GE30 ES-2RS	0,153
35	55	25	20	39	80	400	6	GE35 ES	0,233
	55	25	20	39	80	400	6	GE35 ES-2RS	0,233
40	62	28	22	45	100	500	7	GE40 ES	0,306
	62	28	22	45	100	500	7	GE40 ES-2RS	0,306
45	68	32	25	50	127	640	7	GE45 ES	0,427
	68	32	25	50	127	640	7	GE45 ES-2RS	0,427
50	75	35	28	55	156	780	6	GE50 ES	0,546
	75	35	28	55	156	780	6	GE50 ES-2RS	0,546
60	90	44	36	66	245	1220	6	GE60 ES	1,045
	90	44	36	66	245	1220	6	GE60 ES-2RS	1,045
70	105	49	40	77	315	1560	6	GE70 ES	1,55
	105	49	40	77	315	1560	6	GE70 ES-2RS	1,55
80	120	55	45	88	400	2000	6	GE80 ES	2,31
	120	55	45	88	400	2000	6	GE80 ES-2RS	2,31
90	130	60	50	98	490	2450	5	GE90 ES	2,75

Spherical plain radial bearings with fitting crack

Two seals and fitting crack, fitting groove

ISO 6124-1979, ISO 6125-1979

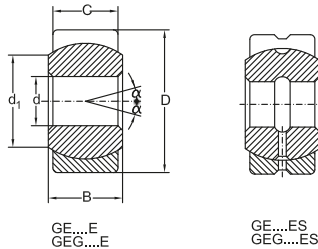

Dimensions				Load ratings			Designation	Mass	
d	D	B	C	d ₁ min	dyn.	stat.			α^*
mm					kN	kN	-	kg	
90	130	60	50	98	490	2450	5	GE90 ES-2RS	2,75
100	150	70	55	109	610	3050	7	GE100 ES	4,45
	150	70	55	109	610	3050	7	GE100 ES-2RS	4,45
110	160	70	55	120	655	3250	6	GE110 ES	4,82
	160	70	55	120	655	3250	6	GE110 ES-2RS	4,82
120	180	85	70	130	950	4750	6	GE120 ES	8,05
	180	85	70	130	950	4750	6	GE120 ES-2RS	8,05
140	210	90	70	150	1080	5400	7	GE140 ES	11,02
	210	90	70	150	1080	5400	7	GE140 ES-2RS	11,02
160	230	105	80	170	1370	6800	8	GE160 ES	14,01
	230	105	80	170	1370	6800	8	GE160 ES-2RS	14,01
180	260	105	80	192	1530	7650	6	GE180 ES	18,65
	260	105	80	192	1530	7650	6	GE180 ES-2RS	18,65
	260	105	80	192	1530	7650	6	GE180 DS	18,65
200	290	130	100	212	2120	10600	7	GE200 ES	28,03
	290	130	100	212	2120	10600	7	GE200 ES-2RS	28,03
	290	130	100	212	2120	10600	7	GE200 DS	28,03
220	320	135	100	238	2320	11600	8	GE220 ES	35,91
	320	135	100	238	2320	11600	8	GE220 ES-2RS	35,91
	320	135	100	238	2320	11600	8	GE220 DS	35,91
240	340	140	100	265	2550	12700	8	GE240 ES	39,91
	340	140	100	265	2550	12700	8	GE240 ES-2RS	39,91
	340	140	100	265	2550	12700	8	GE240 DS	39,91
260	370	150	110	285	3050	15300	7	GE260 ES	51,84
	370	150	110	285	3050	15300	7	GE260 ES-2RS	51,84
	370	150	110	285	3050	15300	7	GE260 DS	51,84
280	400	155	120	310	3550	18000	6	GE280 ES	65,36
	400	155	120	310	3550	18000	6	GE280 ES-2RS	65,36
	400	155	120	310	3550	18000	6	GE280 DS	65,36
300	430	165	120	330	3800	19000	7	GE300 ES	78,07
	430	165	120	330	3800	19000	7	GE300 ES-2RS	78,07
	430	165	120	330	3800	19000	7	GE300 DS	78,07

*The sizes are not binding.

Spherical plain radial bearings with fitting crack

Two seals and fitting crack, fitting groove

ISO 6124-1979, ISO 6125-1979

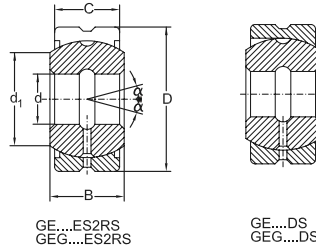

Dimensions				Load ratings			Designation	Mass	
d	D	B	C	d ₁ min	dyn.	stat.			α*
mm				kN			-	kg	
4	14	7	4	7	3,4	17	20	GEG4 E	0,0045
5	16	9	5	8	5,5	27	21	GEG5 S	0,0066
6	16	9	5	9	5,5	27	21	GEG6 S	0,0081
8	19	11	6	11	8,1	40	21	GEG8 E	0,014
10	22	12	7	13	10	54	18	GEG10 E	0,021
12	26	15	9	16	17	85	18	GEG12 E	0,033
15	30	16	10	19	21	106	16	GEG15 E	0,049
	30	16	10	19	21	106	16	GEG15 ES-2RS	0,049
17	35	20	12	21	30	146	19	GEG17 ES	0,083
	35	20	12	21	30	146	19	GEG17 ES-2RS	0,083
20	42	25	16	24	48	240	17	GEG20 ES	0,153
	42	25	16	24	48	240	17	GEG20 ES-2RS	0,153
25	47	28	18	29	62	310	17	GEG25 ES	0,203
	47	28	18	29	62	310	17	GEG25 ES-2RS	0,203
30	55	32	20	34	80	400	17	GEG30 ES	0,304
	55	32	20	34	80	400	17	GEG30 ES-2RS	0,304
35	62	35	22	39	100	500	16	GEG35 ES	0,408
	62	35	22	39	100	500	16	GEG35 ES-2RS	0,408
40	68	40	25	44	127	640	17	GEG40 ES	0,542
	68	40	25	44	127	640	17	GEG40 ES-2RS	0,542
45	75	43	28	50	156	780	15	GEG45 ES	0,713
	75	43	28	50	156	780	15	GEG45 ES-2RS	0,713
50	90	56	36	57	245	1220	17	GEG50 ES	1,44
	90	56	36	57	245	1220	17	GEG50 ES-2RS	1,44
60	105	63	40	67	315	1560	17	GEG60 ES	1,60
	105	63	40	67	315	1560	17	GEG60 ES-2RS	1,60
70	120	70	45	77	400	2000	16	GEG70 ES	3,01
	120	70	45	77	400	2000	16	GEG70 ES-2RS	3,01
80	130	75	50	87	490	2450	14	GEG80 ES	3,64
	130	75	50	87	490	2450	14	GEG80 ES-2RS	3,64

Spherical plain radial bearings with fitting crack

Two seals and fitting crack, fitting groove

ISO 6124-1979, ISO 6125-1979

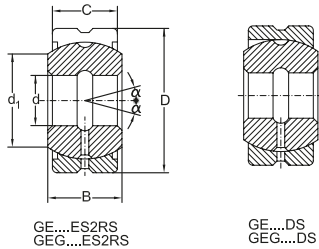

Dimensions				Load ratings			Designation	Mass	
d	D	B	C	d ₁ min	dyn.	stat.	α*		
mm					kN	kN	-	kg	
90	150	85	55	98	610	3050	15	GEG90 ES	5,22
	150	85	55	98	610	3050	15	GEG90 ES-2RS	5,22
100	160	85	55	110	655	3250	14	GEG100 ES	6,05
	160	85	55	110	655	3250	14	GEG100 ES-2RS	6,05
110	180	100	70	122	950	4750	12	GEG110 ES	9,68
	180	100	70	122	950	4750	12	GEG110 ES-2RS	9,68
120	210	115	70	132	1080	5400	16	GEG120 ES	14,72
	210	115	70	132	1080	5400	16	GEG120 ES-2RS	14,72
140	230	130	80	151	1370	6800	16	GEG140 ES	19,01
	230	130	80	151	1370	6800	16	GEG140 ES-2RS	19,01
160	260	135	80	176	1530	7650	16	GEG160 ES	20,02
	260	135	80	176	1530	7650	16	GEG160 ES-2RS	20,02
	260	135	80	176	1530	7650	16	GEG160 DS	20,02
180	290	155	100	196	2120	10600	14	GEG180 ES	32,21
	290	155	100	196	2120	10600	14	GEG180 ES-2RS	32,21
	290	155	100	196	2120	10600	14	GEG180 DS	32,21
200	320	165	100	220	2320	11600	15	GEG200 ES	45,28
	320	165	100	220	2320	11600	15	GEG200 ES-2RS	45,28
	320	165	100	220	2320	11600	15	GEG200 DS	45,28
220	340	175	100	243	2550	12700	16	GEG220 ES	51,12
	340	175	100	243	2550	12700	16	GEG220 ES-2RS	51,12
	340	175	100	243	2550	12700	16	GEG220 DS	51,12
240	370	190	110	263	3050	15300	15	GEG240 ES	65,12
	370	190	110	263	3050	15300	15	GEG240 ES-2RS	65,12
	370	190	110	263	3050	15300	15	GEG240 DS	65,12
260	400	205	120	285	3550	18000	15	GEG260 ES	82,44
	400	205	120	285	3550	18000	15	GEG260 ES-2RS	82,44
	400	205	120	285	3550	18000	15	GEG260 DS	82,44
280	430	210	120	310	3800	19000	15	GEG280 ES	97,21
	430	210	120	310	3800	19000	15	GEG280 ES-2RS	97,21
	430	210	120	310	3800	19000	15	GEG280 DS	97,21

*The sizes are not binding.

Spherical plain radial bearings with wide inner ring and fitting crack

Two seals and wide inner ring and fitting crack

ISO 61204/2-1982

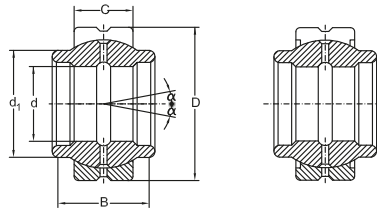

GEEW...ES

GEEW...ES2RS
GEEW...ES2RS

Dimensions				Load ratings			Designation	Mass	
d	D	B	C	d ₁ min	dyn.	stat.	α*		
mm					kN	kN	-	kg	
12	22	12	7	15,5	10	54	4	GEEW12 ES	0,022
	22	12	7	15,5	10	54	4	GEEW12 ES-2RS*	0,022
15	26	15	9	18,5	17	85	5	GEEW15 ES	0,031
	26	15	9	18,5	17	85	5	GEEW15 ES-2RS	0,031
16	28	16	9	20	17	85	4	GEEW16 ES	0,035
	28	16	9	20	17	85	4	GEEW16 ES-2RS	0,035
17	30	17	10	21	21	106	7	GEEW17 ES	0,044
	30	17	10	21	21	106	7	GEEW17 ES-2RS	0,044
20	35	20	12	25	30	146	4	GEEW20 ES	0,071
	35	20	12	25	30	146	4	GEEW20 ES-2RS	0,071
25	42	25	16	30,5	48	240	4	GEEW25 ES	0,131
	42	25	16	30,5	48	240	4	GEEW25 ES-2RS	0,131
30	47	30	18	34	62	310	4	GEEW30 ES	0,168
	47	30	18	34	62	310	4	GEEW30 ES-2RS	0,168
32	52	32	18	37	62	310	4	GEEW32 ES	0,182
	52	32	18	37	62	310	4	GEEW32 ES-2RS	0,182
35	55	35	20	40	80	400	4	GEEW35 ES	0,253
	55	35	20	40	80	400	4	GEEW35 ES-2RS	0,253
40	62	40	22	46	100	500	4	GEEW40 ES	0,338
	62	40	22	46	100	500	4	GEEW40 ES-2RS	0,338
45	68	45	25	52	127	640	4	GEEW45 ES	0,481
	68	45	25	52	127	640	4	GEEW45 ES-2RS	0,481
50	75	50	28	57	156	780	4	GEEW50 ES	0,558
	75	50	28	57	156	780	4	GEEW50 ES-2RS	0,558
60	90	60	36	68	245	1220	3	GEEW60 ES	1,15
	90	60	36	68	245	1220	3	GEEW60 ES-2RS	1,15
63	95	63	36	71,5	245	1220	4	GEEW63 ES	1,23
	95	63	36	71,5	245	1220	4	GEEW63 ES-2RS	1,23
70	105	70	40	78	315	1560	4	GEEW70 ES	1,71
	105	70	40	78	315	1560	4	GEEW70 ES-2RS	1,71

Spherical plain radial bearings with wide inner ring and fitting crack

Two seals and wide inner ring and fitting crack

ISO 61204/2-1982

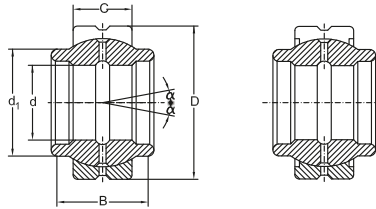

GEEW...ES

GEEW...ES2RS
GEEM...ES2RS

Dimensions				Load ratings			Designation	Mass	
d	D	B	C	d ₁ min	dyn.	stat.	α*		
mm					kN	kN	-	kg	
80	120	80	45	91	400	2000	4	GEEW80 ES	2,39
	120	80	45	91	400	2000	4	GEEW80 ES-2RS	2,39
100	150	100	55	113	610	3050	4	GEEW100 ES	4,80
	150	100	55	113	610	3050	4	GEEW100 ES-2RS	4,80
125	180	125	70	138	950	4750	4	GEEW125 ES	8,50
	180	125	70	138	950	4750	4	GEEW125 ES-2RS	8,50
20	35	24	12	24	30	146	6	GEEM20 ES-2RS	0,073
25	42	29	16	29	48	240	4	GEEM25 ES-2RS	0,13
30	47	30	18	34	62	310	4	GEEM30 ES-2RS	0,17
35	55	35	20	40	80	400	4	GEEM35 ES-2RS	0,25
40	62	38	22	45	100	500	4	GEEM40 ES-2RS	0,35
45	68	40	25	52	127	640	4	GEEM45 ES-2RS	0,49
50	75	43	28	57	156	780	4	GEEM50 ES-2RS	0,60
60	90	54	36	68	245	1220	3	GEEM60 ES-2RS	1,15
70	105	65	40	78	315	1560	4	GEEM70 ES-2RS	1,65
80	120	74	45	90	400	2000	4	GEEM80 ES-2RS	2,50

*The sizes are not binding.

Maintenance free spherical plain radial bearings

GB304.7-81, GB304.9-81 (ISO6124-1979, ISO6125-1979)

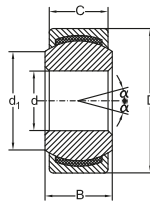

GE...C
GE...ET2RS

Dimensions					Load ratings		α^*	Designation	Mass
d	D	B	C	d_1 min	dyn.	stat.			
mm					kN	kN	-	kg	
4	12	5	3	6	2,1	5,4	16	GE4 C	0,0033
5	14	6	4	7	3,6	9,1	13	GE5 C	0,0038
6	14	6	4	8	3,6	9,1	13	GE6 C	0,0042
8	16	8	5	10	5,8	14	15	GE8 C	0,0075
10	19	9	6	13	8,6	21	12	GE10 C	0,011
12	22	10	7	15	11	28	10	GE12 C	0,015
15	26	12	9	18	18	45	8	GE15 C	0,027
17	30	14	10	20	22	56	10	GE17 C	0,041
20	35	16	12	24	31	78	9	GE20 C	0,066
	35	16	12	24	31	78	9	GE20 ET-2RS	0,066
25	42	20	16	29	51	127	7	GE25 C	0,119
	42	20	16	29	51	127	7	GE25 ET-2RS	0,119
30	47	22	18	34	65	166	6	GE30 C	0,163
	47	22	18	34	65	166	6	GE30 ET-2RS	0,163
35	55	25	20	-	110	220	6	GE35 ET-2RS	0,25
40	62	28	22	-	140	280	6	GE40 ET-2RS	0,30
45	68	32	25	-	180	350	6	GE45 ET-2RS	0,35
50	75	35	28	-	220	430	6	GE50 ET-2RS	0,50
60	90	44	36	-	340	690	6	GE60 ET-2RS	1,00
70	105	49	40	-	430	870	6	GE70 ET-2RS	1,40
80	120	55	45	-	560	1140	6	GE80 ET-2RS	2,00
90	130	60	50	-	690	1350	6	GE90 ET-2RS	2,50

Maintenance free spherical plain radial bearings GB304.7-81, GB304.9-81 (ISO6124-1979, ISO6125-1979)

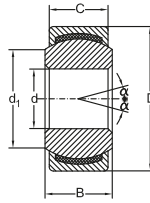

GE...C
GE...ET2RS

Dimensions		B	C	d ₁ min	Load ratings		α*	Designation	Mass
d	D				dyn.	stat.			
mm					kN	kN	-	kg	
100	150	70	55	-	850	1700	6	GE100 ET-2RS	4,00
110	160	70	55	-	900	1850	6	GE110 ET-2RS	4,50
120	180	85	70	-	1300	2700	6	GE120 ET-2RS	7,20
140	210	90	70	-	1500	3000	6	GE140 ET-2RS	10,00

Maintenance free spherical plain radial bearings

ISO6124-1979, ISO 6125-1979

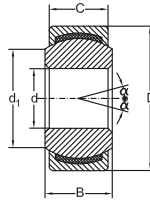

GE...C
GE...ET2RS

Dimensions				Load ratings				Designation	Mass
d	D	B	C	d ₁ min	dyn.	stat.	α*		
mm					kN	kN		-	kg
4	14	7	4	7	3,6	9,1	20	GEG4 C	0,0045
5	16	9	5	8	5,8	14	21	GEG5 C	0,0066
6	16	9	5	9	5,8	14	21	GEG6 C	0,0081
8	19	11	6	11	8,8	21	21	GEG8 C	0,014
10	22	12	7	13	11	28	18	GEG10 C	0,021
12	26	15	9	16	18	45	18	GEG12 C	0,033
15	30	16	10	19	22	56	16	GEG15 C	0,049
17	35	20	12	21	31	78	19	GEG17 C	0,083
20	42	25	16	24	51	127	17	GEG20 C	0,153
25	47	28	18	29	65	166	17	GEG25 C	0,203
30	55	32	20	34	83	212	17	GEG30 C	0,304
	55	32	20	-	110	220	17	GEG30 ET-2RS	0,30
35	62	35	22	-	140	270	17	GEG35 ET-2RS	0,35
40	68	40	25	-	180	350	15	GEG40 ET-2RS	0,50
45	75	43	28	-	220	430	15	GEG45 ET-2RS	0,60
50	90	56	36	-	340	680	15	GEG50 ET-2RS	1,40
60	105	63	40	-	430	850	15	GEG60 ET-2RS	2,00
70	120	70	45	-	550	1100	16	GEG70 ET-2RS	2,80
80	130	75	50	-	680	1350	14	GEG80 ET-2RS	3,40
90	150	85	55	-	850	1700	15	GEG90 ET-2RS	5,00
100	160	85	55	-	900	1800	14	GEG100 ET-2RS	5,50
110	180	100	70	-	1300	2700	12	GEG110 ET-2RS	9,00
120	210	115	70	-	1500	3000	15	GEG120 ET-2RS	14,50
140	230	130	80	-	1900	3500	15	GEG140 ET-2RS	18,20

*The sizes are not binding.

ET/C - To line SF1 material on the surface of spherical plain.

Angular contact spherical plain bearings

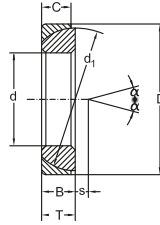

GAC...S

Dimensions						Load ratings			Designation	Mass	
d	D	B	C	T	d ₁	S	dyn.	stat.	α*		
mm							kN	kN	-	kg	
25	47	15	14	15	42	0,6	47,5	236	3,5	GAC25 S	0,148
30	55	17	15	17	49,5	1,3	63	315	3	GAC30 S	0,208
35	62	18	16	18	55,5	2,1	76,5	390	3	GAC35 S	0,268
40	68	19	17	19	62	2,8	90	450	3	GAC40 S	0,327
45	75	20	18	20	68,5	3,5	106	530	3	GAC45 S	0,416
50	80	20	19	20	74	4,3	118	585	3	GAC50 S	0,455
60	95	23	21	23	88,5	5,7	160	800	3	GAC60 S	0,714
70	110	25	23	25	102	7,2	208	1040	2,5	GAC70 S	1,04
80	125	29	25,5	29	115	8,6	250	1250	2,5	GAC80 S	1,54
90	140	32	28	32	128,5	10,1	320	1600	2,5	GAC90 S	2,09
100	150	32	31	32	141	11,6	345	1760	2	GAC100 S	2,34
110	170	38	34	38	155	13	475	2360	2	GAC110 S	3,68
120	180	38	37	38	168	14,5	510	2550	2	GAC120 S	3,97

*The sizes are not binding.

On request: sliding contact surface steel / PTFE, example GX...C.

Spherical plain thrust bearing

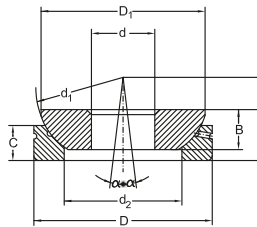

GX...S

Dimensions						Load ratings			Designation	Mass			
d	D	H	B	C	d ₁	d ₂	D ₁	S	dyn. kN	stat. kN	α*		kg
10	30	9,5	7,5	7	32	15,5	27,5	7	24	120	9	GX10 S	0,036
12	35	13	9,5	9,3	38	18	32	8	32,5	163	8	GX12 S	0,072
15	42	15	11	10,8	46	22,5	39	10	52	260	8	GX15 S	0,108
17	47	16	11,8	11,2	52	27	43,5	11	58,5	300	10	GX17 S	0,137
20	55	20	14,5	13,8	60	31	50	12,5	75	375	9	GX20 S	0,246
25	62	22,5	16,5	16,7	68	34,5	58,5	14	129	640	7	GX25 S	0,415
30	75	26	19	19	82	42	70	17,5	170	850	7	GX30 S	0,614
35	90	28	22	20,7	98	50,5	84	22	260	1290	8	GX35 S	0,973
40	105	32	27	21,5	114	59	97	24,5	375	1860	9	GX40 S	1,59
45	120	36,5	31	25,5	128	67	110	27,5	490	2450	9	GX45 S	2,24
50	130	42,5	33	30,5	139	70	120	30	655	3250	7	GX50 S	3,14
60	150	45	37	34	160	84	140	35	735	3650	8	GX60 S	4,63
70	160	50	42	36,5	176	94,5	153	35	800	4050	8	GX70 S	5,37
80	180	50	43,5	38	197	107,5	172	42,5	1040	5200	8	GX80 S	6,91
100	210	59	51	46	222	127	198	45	1200	6000	8	GX100 S	10,98
120	230	64	53,5	50	250	145	220	52,5	1250	6200	6	GX120 S	13,97

*The sizes are not binding.

On request: sliding contact surface steel / PTFE, example GX...C.

Spherical plain radial bearings dimension in inches with fitting crack Two seals and fitting crack

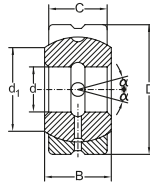

GE.Z....ES

Dimensions				Load ratings			α*	Designation	Mass
d	D	B	C	d ₁ min	dyn.	stat.			
mm				kN			-	kg	
12,7	22,225	11,1	9,525	14,1	13,7	41,5	6	GEZ12 ES	0,022
15,875	26,988	13,894	11,913	18,3	22,0	65,5	6	GEZ15 ES	0,036
19,05	31,75	16,662	14,275	21,8	31,5	95,0	6	GEZ19 ES	0,053
22,225	36,513	19,431	16,662	25,4	4,25	127	6	GEZ22 ES	0,085
25,4	41,275	22,225	19,05	27,6	56,0	166	6	GEZ25 ES	0,121
	41,275	22,225	19,05	27,6	56,0	166	6	GEZ25 ES-2RS	0,121
31,75	50,8	27,762	23,8	36,0	86,5	260	6	GEZ31 ES	0,232
	50,8	27,762	23,8	36,0	86,5	260	6	GEZ31 ES-2RS	0,232
34,925	55,563	30,15	26,187	38,6	102	310	6	GEZ34 ES	0,351
	55,563	30,15	26,187	38,6	102	310	6	GEZ34 ES-2RS	0,351
38,1	61,913	33,325	28,575	41,2	125	375	6	GEZ38 ES	0,422
	61,913	33,325	28,575	41,2	125	375	6	GEZ38 ES-2RS	0,422
44,5	71,438	38,887	33,325	50,7	170	510	6	GEZ44 ES	0,641
	71,438	38,887	33,325	50,7	170	510	6	GEZ44 ES-2RS	0,641
50,8	80,963	44,45	38,1	57,9	224	670	6	GEZ50 ES	0,932
	80,963	44,45	38,1	57,9	224	670	6	GEZ50 ES-2RS	0,932
57,15	90,488	50,013	42,85	64,9	280	850	6	GEZ57 ES	1,33
	90,488	50,013	42,85	64,9	280	850	6	GEZ57 ES-2RS	1,33
63,5	100,013	55,55	47,625	73,3	355	1060	6	GEZ63 ES	1,85
	100,013	55,55	47,625	73,3	355	1060	6	GEZ63 ES-2RS	1,85
69,85	111,125	61,112	52,375	79,1	415	1250	6	GEZ69 ES	2,42
	111,125	61,112	52,375	79,1	415	1250	6	GEZ69 ES-2RS	2,42
76,2	120,65	66,675	57,15	86,8	500	1500	6	GEZ76 ES	3,10
	120,65	66,675	57,15	86,8	500	1500	6	GEZ76 ES-2RS	3,10
82,55	130,175	72,238	61,9	94,5	585	1760	6	GEZ82 ES	3,82
	130,175	72,238	61,9	94,5	585	1760	6	GEZ82 ES-2RS	3,82
88,9	139,7	77,775	66,675	101,6	680	2040	6	GEZ88 ES	4,79
	139,7	77,775	66,675	101,6	680	2040	6	GEZ88 ES-2RS	4,79

Spherical plain radial bearings dimension in inches with fitting crack Two seals and fitting crack

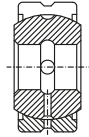

GEZ...ES2RS

Dimensions				Load ratings			α*	Designation	Mass
d	D	B	C	d ₁ min	dyn.	stat.			
mm				kN			-	kg	
95,25	149,225	83,337	71,425	108,7	780	2360	6	GEZ95 ES	5,78
	149,225	83,337	71,425	108,7	780	2360	6	GEZ95 ES-2RS	5,78
101,6	158,75	88,9	76,2	115,8	900	2650	6	GEZ101 ES	6,99
	158,75	88,9	76,2	115,8	900	2650	6	GEZ101 ES-2RS	6,99
107,95	168,275	94,463	80,95	122,8	1000	3000	6	GEZ107 ES	8,41
	168,275	94,463	80,95	122,8	1000	3000	6	GEZ107 ES-2RS	8,41
114,3	177,8	100,013	85,725	130,6	1120	3400	6	GEZ114 ES	9,79
	177,8	100,013	85,725	130,6	1120	3400	6	GEZ114 ES-2RS	9,79
120,65	187,325	105,562	90,475	137,6	1250	3750	6	GEZ120 ES	11,5
	187,325	105,562	90,475	137,6	1250	3750	6	GEZ120 ES-2RS	11,5
127	196	111,125	95,25	145,3	1400	4150	6	GEZ127 ES	13,5
	196	111,125	95,25	145,3	1400	4150	6	GEZ127 ES-2RS	13,5
152,4	222,25	120,65	104,775	168,2	1730	5200	5	GEZ152 ES	17,5
	222,25	120,65	104,775	168,2	1730	5200	5	GEZ152 ES-2RS	17,5

*The sizes are not binding.

Spherical plain radial bearings with two piece outer ring

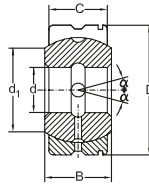

GE....XSK

Dimensions		B	C	d ₁ min	Load ratings		α*	Designation	Mass
d	D				dyn.	stat.			
mm					kN	kN	-	kg	
12	22	11	9	14	12,9	39,2	7	GE12 XS-K	0,019
15	26	13	11	17,5	19,5	57,8	6	GE15 XS-K	0,028
20	32	16	14	23	31,3	94,8	4	GE20 XS-K	0,053
22	37	19	16	25,5	40,3	122	6	GE22 XS-K	0,085
25	42	21	18	29	51,1	155	5	GE25 XS-K	0,116
30	50	27	23	36	81,2	248	6	GE30 XS-K	0,225
35	55	30	26	40	103	314	5	GE35 XS-K	0,302
40	62	33	28	44	122	370	6	GE40 XS-K	0,375
45	72	36	31	50,5	152	461	5	GE45 XS-K	0,598
50	80	42	36	58,5	225	622	5	GE50 XS-K	0,869
55	90	47	40	64,5	253	768	6	GE55 XS-K	1,26
60	100	53	45	72,5	321	980	6	GE60 XS-K	1,72
65	105	55	47	76	350	1060	5	GE65 XS-K	2,05
70	110	58	50	81,5	396	1220	5	GE70 S-K	2,23
75	120	64	55	89,5	478	1450	5	GE75 XS-K	3,01
80	130	70	60	97,5	571	1730	5	GE80 XS-K	3,98
85	135	74	63	100,5	624	1890	6	GE85 XS-K	4,31
90	140	76	65	105,5	670	2030	5	GE90 XS-K	4,72
95	150	82	70	113,5	776	2350	5	GE95 XS-K	6,05
100	160	88	75	121,5	891	2700	5	GE100 XS-K	7,43

Spherical plain radial bearings with two piece outer ring

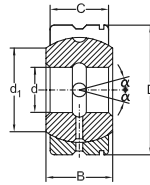

GE...XSK

Dimensions					Load ratings			Designation	Mass
d	D	B	C	d ₁ min	dyn.	stat.	α^*		
mm					kN	kN	-	kg	
110	170	93	80	130	1010	3070	5	GE110 XS-K	8,54
115	180	98	85	132,5	1110	3370	5	GE115 XS-K	10,3
120	190	105	90	140	1250	3780	6	GE120 XS-K	12,4
130	200	110	95	148,5	1390	4220	5	GE130 XS-K	13,8
150	220	120	105	166	1710	5170	5	GE150 XS-K	17,1

Spherical plain radial bearings with two seals and two piece outer ring

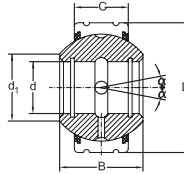

GEK...XS2ES

Dimensions		B	C	d ₁ min	Load ratings		α*	Designation	Mass
d	D				dyn.	stat.			
mm					kN	kN	-	kg	
25	68	40	28	30	117	590	19	GEK25 XS-2RS	0,516
30	70	47	32	37,3	163	813	19	GEK30 XS-2RS	0,785
35	80	54	38	44,5	226	1130	17	GEK35 XS-2RS	1,23
40	90	64	44	48	298	1490	19	GEK40 XS-2RS	1,83
45	100	72	52	54	398	1990	17	GEK45 XS-2RS	2,56
50	110	80	58	60	493	2450	17	GEK50 XS-2RS	3,43
55	125	90	64	63,2	598	2990	19	GEK55 XS-2RS	5,02
60	135	98	72	69,3	732	3660	17	GEK60 XS-2RS	6,43

Ball joint ends with one shank

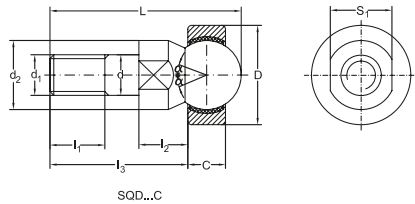

Dimensions										Load ratings			Designation	Mass
d	d ₁	d ₂ min	L _{max}	I ₁ min	I ₂	I ₃ max	S ₁	C	D	dyn.	stat.	α*		
mm										kN	kN	-	kg	
5	M5	9	27,5	8	8	19	7	6	16	2,4	6,2	25	SQD5 C	0,014
6	M6	10	33,5	11	8,8	23,8	8	6,75	18	3,2	8,1	25	SQD6 C	0,021
8	M8	12	41	12	11,6	28,6	10	9	22	5,5	14	25	SQD8 C	0,042
10	M10x1,25	14	49	15	14,2	34,2	11	10,5	26	7,8	20	25	SQD10 C	0,067
12	M12x1,25	19	55,1	17	15,1	38,1	16	12	30	10	27	25	SQD12 C	0,108
14	M14x1,25	19	70,7	22	16,8	51,3	16	13,5	34	13	35	20	SQD14 C	0,167
16	M16x1,25	22	76,3	23	18	54,5	18	15	38	17	45	20	SQD16 C	0,238

Winding shape ball joint rod ends

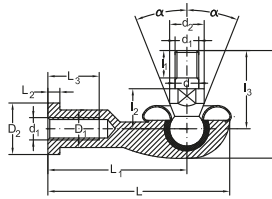

Dimensions

d	d ₁	d ₂ min	d ₃ max	l max	l ₁ min	l ₂	l ₃ max	S ₁	L max	L ₁
mm										
5	M5	9	20	30	8	10	21	7	36	27
	M5	9	20	30	8	10	21	7	36	27
6	M6	10	20	36	11	11	26	8	40,5	30
	M6	10	20	36	11	11	26	8	40,5	30
8	M8	12	24	43,5	12	14	31	10	49	36
	M8	12	24	43,5	12	14	31	10	49	36
10	M10X1,25	14	30	51,5	15	17	37	11	58	43
	M10X1,25	14	30	51,5	15	17	37	11	58	43
12	M12X1,25	19	32	57,5	17	19	42	16	66	50
	M12X1,25	19	32	57,5	17	19	42	16	66	50
14	M14X1,25	19	38	73,5	22	21,5	56	16	75	57
	M14X1,25	19	38	73,5	22	21,5	56	16	75	57
16	M16X1,25	22	44	79,5	23	23,5	60	18	84	64
	M16X1,25	22	44	79,5	23	23,5	60	18	84	64
18	M18X1,25	25	45	90	25	26,5	68	21	93	71
	M18X1,25	25	45	90	25	26,5	68	21	93	71
20	M20X1,25	29	50	90	25	27	68	24	99	77
	M20X1,25	29	50	90	25	27	68	24	99	77
22	M22X1,25	29	52	95	26	28	70	24	109	84
	M22X1,25	29	52	95	26	28	70	24	109	84

Winding shape ball joint rod ends

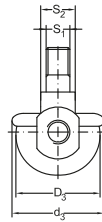

I ₂ max	I ₃ min	D ₁ max	D ₂ max	D ₃ max	S ₂	Load ratings		α*	Designation	Mass
						dyn. kN	stat. kN			
4	14	9	12	18	10	2,7	9,2	25	SQ5 C	0,025
4	14	9	12	18	10	2,7	9,2	25	SQ5 C-RS	0,025
5	14	10	13	20	10	3,6	12	25	SQ6 C	0,039
5	14	10	13	20	10	3,6	12	25	SQ6 C-RS	0,039
5	17	12,5	16	25	13	5,7	19	25	SQ8 C	0,068
5	17	12,5	16	25	13	5,7	19	25	SQ8 C-RS	0,068
6,5	21	15	19	29	16	8,2	27	25	SQ10 C	0,112
6,5	21	15	19	29	16	8,2	27	25	SQ10 C-RS	0,112
6,5	25	17,5	22	31	18	11	37	25	SQ12 C	0,164
6,5	25	17,5	22	31	18	11	37	25	SQ12 C-RS	0,164
8	26	20	25	35	21	14	48	25	SQ14 C	0,254
8	26	20	25	35	21	14	48	25	SQ14 C-RS	0,254
8	32	22	27	39	24	16	53	20	SQ16 C	0,336
8	32	22	27	39	24	16	53	20	SQ16 C-RS	0,336
10	34	25	31	44	27	18	61	20	SQ18 C	0,464
10	34	25	31	44	27	18	61	20	SQ18 C-RS	0,464
10	35	27,5	34	44	30	18	612	20	SQ20 C	0,538
10	35	27,5	34	44	30	18	612	20	SQ20 C-RS	0,538
12	41	30	37	50	30	22	75	16	SQ22 C	0,713
12	41	30	37	50	30	22	75	16	SQ22 C-RS	0,713

*The sizes are not binding.

Available with thread M1,5 (SQ10 and SQ12) and M2 (SQ14 and SQ16)

C - to line SF1 material on the surface of spherical plain. The shank of ball joint housing may be left - hand thread, for left - hand thread, suffix "L" is added to bearings number and thread sign, e. g. SQL6C, M6L - 6H.

Straightball joint rod ends

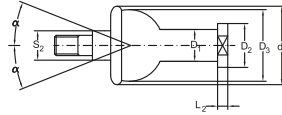
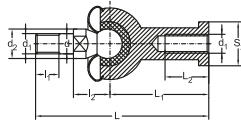

SQZ...CRS

Dimensions

d	d ₁	d ₂ min	d ₃ max	l ₁ min	l ₂	S ₁	L max	L ₁	L ₂ max	L ₃ min
mm										
5	M5	9	20	8	11	7	46	24	4	12
	M5	9	20	8	11	7	46	24	4	12
6	M6	10	20	11	12,2	8	55,2	28	5	15
	M6	10	20	11	12,2	8	55,2	28	5	15
8	M8	12	24	12	16	10	65	32	5	16
	M8	12	24	12	16	10	65	32	5	16
10	M10X1,25	14	30	15	19,5	11	74,5	35	6,5	18
	M10X1,25	14	30	15	19,5	11	74,5	35	6,5	18
12	M12X1,25	19	32	17	21	16	84	40	6,5	20
	M12X1,25	19	32	17	21	16	84	40	6,5	20
14	M14X1,25	19	38	22	23,5	16	104,5	45	8	25
	M14X1,25	19	38	22	23,5	16	104,5	45	8	25
16	M16X1,25	22	44	23	25,5	18	112	50	8	27
	M16X1,25	22	44	23	25,5	18	112	50	8	27
18	M18X1,25	25	45	25	31	21	130,5	58	10	32
	M18X1,25	25	45	25	31	21	130,5	58	10	32
20	M20X1,25	29	50	25	31	24	133	63	10	38
	M20X1,25	29	50	25	31	24	133	63	10	38
22	M22X1,25	29	52	26	33	24	145	70	12	43
	M22X1,25	29	52	26	33	24	145	70	12	43

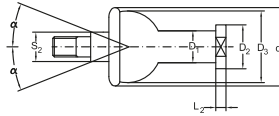
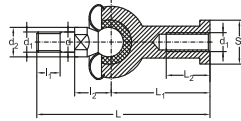

SQZ...C-RS

D ₁ max	D ₂ max	D ₃ max	S ₂	Load ratings		α*	Designation	Mass
				dyn. kN	stat. kN			
9	12	17	10	1,7	5,7	15	SQZ5 C	0,025
9	12	17	10	1,7	5,7	15	SQZ5 C-RS	0,025
10	13	20	10	2,2	7,5	15	SQZ6 C	0,040
10	13	20	10	2,2	7,5	15	SQZ6 C-RS	0,040
12,5	16	24	13	3,3	11	15	SQZ8 C	0,075
12,5	16	24	13	3,3	11	15	SQZ8 C-RS	0,075
15	19	28	16	4,8	16	15	SQZ10 C	0,121
15	19	28	16	4,8	16	15	SQZ10 C-RS	0,121
17,5	22	32	18	6,6	22	15	SQZ12 C	0,187
17,5	22	32	18	6,6	22	15	SQZ12 C-RS	0,187
20	25	36	21	8,7	29	11	SQZ14 C	0,277
20	25	36	21	8,7	29	11	SQZ14 C-RS	0,277
22	27	40	24	10	33	11	SQZ16 C	0,361
22	27	40	24	10	33	11	SQZ16 C-RS	0,361
25	31	45	27	11	37	11	SQZ18 C	0,539
25	31	45	27	11	37	11	SQZ18 C-RS	0,539
27,5	34	45	30	11	37	7,5	SQZ20 C	0,575
27,5	34	45	30	11	37	7,5	SQZ20 C-RS	0,575
30	37	50	30	14	46	7,5	SQZ22 C	0,757
30	37	50	30	14	46	7,5	SQZ22 C-RS	0,757

*The sizes are not binding.

C - to line SF1 material on the surface of spherical plain. The shank of ball joint housing may be left - hand thread, for left - hand thread, suffix "L" is added to bearings number and thread sign, e. g. SQL6C, M6L - 6H.

Combination (series e) rod ends (ISO 6126 - 1982)

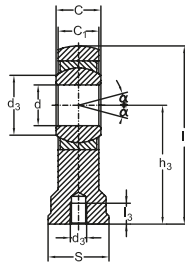

Dimensions

d	B	C ₁ max	d ₁ min	d ₂ max	d ₃	h ₁	l ₃ min	l ₄ max	l ₅ max	d ₄ max
mm										
5	6	4,5	7	21	M5	30	11	42	5	10
6	6	4,5	8	21	M6	30	11	42	5	11
	6	4,5	8	21	M6	30	11	42	5	11
8	8	6,5	10	24	M8	36	15	49	5	13
	8	6,5	10	24	M8	36	15	49	5	13
10	9	7,5	13	29	M10	43	15	58	6,5	16
	9	7,5	13	29	M10	43	15	58	6,5	16
12	10	8,5	15	34	M12	50	18	67	7	18
	10	8,5	15	34	M12	50	18	67	7	18
15	12	10,5	18	40	M14	61	21	81	8	21
	12	10,5	18	40	M14	61	21	81	8	21
	12	10,5	18	40	M14	61	21	81	8	21
17	14	11,5	20	46	M16	67	24	90	10	24
	14	11,5	20	46	M16	67	24	90	10	24
	14	11,5	20	48	M16	67	24	90	10	24
20	16	13,5	24	53	M20x1,5	77	30	104	10	28
	16	13,5	24	53	M20x1,5	77	30	104	10	28
	16	13,5	24	53	M20x1,5	77	30	104	10	28
25	20	18	29	64	M24x2	94	36	126	12	35
	20	18	29	64	M24x2	94	36	126	12	35
	20	18	29	64	M24x2	94	36	126	12	35
30	22	20	34	73	M30x2	110	45	147	15	42
	22	20	34	73	M30x2	110	45	147	15	42
	22	20	34	73	M30x2	110	45	147	15	42

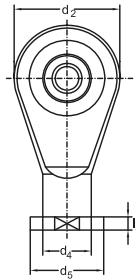

d ₃ max	S	Load ratings			α*	Designation	Mass
		dyn.	stat.				
mm		kN	kN	-	-	kg	
13	10	3,4	8,1	13	SI5 E	0,016	
13	11	3,4	8,1	13	SI6 E	0,017	
13	11	3,4	8,1	13	SI6 C**	0,017	
16	13	5,5	12,9	15	SI8 E	0,035	
16	13	5,5	12,9	15	SI8 C**	0,035	
19	16	8,1	17,6	12	SI10 E	0,061	
19	16	8,1	17,6	12	SI610 C**	0,061	
22	18	10,8	24,5	10	SI12 E	0,096	
22	18	10,8	24,5	10	SI12 C**	0,096	
26	21	17	36	8	SI15 ES	0,162	
26	21	17	36	8	SI15 ES-2RS	0,162	
26	21	17	36	8	SI15 C**	0,162	
29	24	21	45	10	SI17 ES	0,233	
29	24	21	45	10	SI17 ES-2RS	0,233	
29	24	21	45	10	SI17 C**	0,233	
34	30	30	60	9	SI20 ES	0,324	
34	30	30	60	9	SI20 ES-2RS	0,324	
34	30	30	60	9	SI20 C**	0,324	
42	36	48	83	7	SI25 ES	0,625	
42	36	48	83	7	SI25 ES-2RS	0,625	
42	36	48	83	7	SI25 C**	0,625	
50	46	62	110	6	SI30 ES	0,976	
50	46	62	110	6	SI30 ES-2RS	0,976	
50	46	62	110	6	SI30 C**	0,976	

Combination (series e) rod ends (ISO 6126 - 1982)

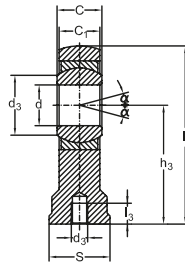

Dimensions

d	B	C ₁ max	d ₁ min	d ₂ max	d ₃	h ₁	l ₃ min	l ₄ max	l ₅ max	d ₄ max
mm										
35	25	22	39	82	M36x2	125	60	167	15	48
	25	22	39	82	M36x2	125	60	167	15	48
	25	22	39	82	M36x2	125	60	167	15	48
40	28	24	45	92	M39x2	142	65	190	18	52
	28	24	45	92	M39x2	142	65	190	18	52
	28	24	45	92	M39x2	142	65	190	18	52
45	32	28	50	102	M42x3	145	65	199	20	58
	32	28	50	102	M42x3	145	65	199	20	58
	32	28	50	102	M42x3	145	65	199	20	58
50	35	31	55	112	M45x3	160	68	221	20	62
	35	31	55	112	M45x3	160	68	221	20	62
	35	31	55	112	M45x3	160	68	221	20	62
60	44	39	66	135	M52x3	175	70	247	20	70
	44	39	66	135	M52x3	175	70	247	20	70
	44	39	66	135	M52x3	175	70	247	20	70
70	49	43	77	160	M56x4	200	80	283	20	80
	49	43	77	160	M56x4	200	80	283	20	80
	49	43	77	160	M56x4	200	80	283	20	80
80	55	48	88	180	M64x4	230	85	325	25	95
	55	48	88	180	M64x4	230	85	325	25	95
	55	48	88	180	M64x4	230	85	325	25	95

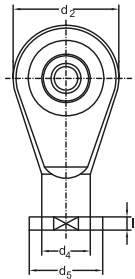

d ₃ max	S	Load ratings			α*	Designation	Mass
		dyn.	stat.				
mm		kN	kN	-	-	kg	
58	55	80	146	6	SI35 ES	1,52	
58	55	80	146	6	SI35 ES-2RS	1,52	
58	55	80	146	6	SI35 C**	1,52	
65	60	100	180	7	SI40 ES	2,06	
65	60	100	180	7	SI40 ES-2RS	2,06	
65	60	100	180	7	SI40 C**	2,06	
70	65	127	240	7	SI45 ES	2,72	
70	65	127	240	7	SI45 ES-2RS	2,72	
70	65	127	240	7	SI45 C-2RS**	2,72	
75	70	156	290	6	SI50 ES	3,57	
75	70	156	290	6	SI50 ES-2RS	3,57	
75	70	156	290	6	SI50 ES-2RS**	3,57	
88	80	245	450	6	SI60 ES	5,63	
88	80	245	450	6	SI60 ES-2RS	5,63	
88	80	245	450	6	SI60 ES-2RS**	5,63	
98	85	315	610	6	SI70 ES	8,33	
98	85	315	610	6	SI70 ES-2RS	8,33	
98	85	315	610	6	SI70 ES-2RS**	8,33	
110	95	400	750	6	SI80 ES	13,04	
110	95	400	750	6	SI80 ES-2RS	13,04	
110	95	400	750	6	SI80 ES-2RS**	13,04	

SIL...ES - for left hand thread. Suffix "L" is added to bearings number and thread sign, eg. SIL30ES. Sliding contact surface: steel/steel. Available with increased thread

*The sizes are not binding.

**Sliding contact surface: steel/PTFE.

Combination (series e) rod ends (ISO 6126 - 1982)

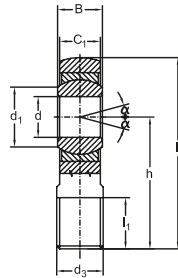

SA...E/ES
SA...ES2RS

Dimensions				Load ratings						Designation	Mass		
d	B	C ₁ max	d ₁ min	d ₂ max	d ₃	h	l ₁ min	l ₂ max	dyn.	stat.	α*		
mm												kN	kN
5	6	4,5	7	21	M5	36	16	48	3,4	8,1	1	SA5 E	0,011
6	6	4,5	8	21	M6	36	16	48	3,4	8,1	13	SA6 E	0,013
	6	4,5	8	21	M6	42	21	48	3,4	8,1	13	SA6 C**	0,013
8	8	6,5	10	24	M8	42	21	55	5,5	12,9	15	SA8 E	0,026
	8	6,5	10	24	M8	42	21	55	5,5	12,9	15	SA8 C**	0,026
10	9	7,5	13	29	M10	48	26	63	8,1	17,8	12	SA10 E	0,044
	9	7,5	13	29	M10	48	26	63	8,1	17,8	12	SA10 C**	0,044
12	10	8,5	15	34	M12	54	28	71	10,8	24,5	10	SA12 E	0,066
	10	8,5	15	34	M12	54	28	71	10,8	24,5	10	SA12 C**	0,066
15	12	105	18	40	M14	63	34	83	17	36	8	SA15 ES	0,121
	12	105	18	40	M14	63	34	83	17	36	8	SA15 ES-2RS	0,121
	12	105	18	40	M14	63	34	83	17	36	8	SA15 C**	0,121
17	14	115	20	46	M16	69	36	92	21	45	10	SA17 ES	0,172
	14	115	20	46	M16	69	36	92	21	45	10	SA17 ES-2RS	0,172
	14	115	20	46	M16	69	36	92	21	45	10	SA17 C**	0,172
20	16	135	24	53	M20x1,5	78	43	105	30	60	9	SA20 ES	0,283
	16	135	24	53	M20x1,5	78	43	105	30	60	9	SA20 ES-2RS	0,283
	16	135	24	53	M20x1,5	78	43	105	30	60	9	SA20 C**	0,283
25	20	18	29	64	M24x2	94	53	126	48	83	7	SA25 ES	0,504
	20	18	29	64	M24x2	94	53	126	48	83	7	SA25 ES-2RS	0,504
	20	18	29	64	M24x2	94	53	126	48	83	7	SA25 C**	0,504
30	22	20	34	73	M30x2	110	65	147	62	110	6	SA30 ES	0,835
	22	20	34	73	M30x2	110	65	147	62	110	6	SA30 ES-2RS	0,835
	22	20	34	73	M30x2	110	65	147	62	110	6	SA30 C**	0,835

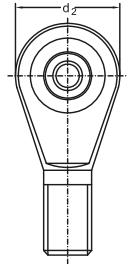

Dimensions									Load ratings			Designation Mass	
d	B	C ₁ max	d ₁ min	d ₂ max	d ₃	h	l ₁ min	l ₂ max	dyn.	stat.	α*		
mm									kN	kN			
35	25	22	39	82	M36x2	140	82	182	80	148	6	SA35 ES	1,41
	25	22	39	82	M36x3	140	82	182	80	148	6	SA35 ES-2RS	1,41
	25	22	39	82	M36x3	140	82	182	80	146	6	SA35 C-2RS**	1,41
40	28	24	45	92	M39x3	150	86	198	100	180	7	SA40 ES	1,86
	28	24	45	92	M39x3	150	86	198	100	180	7	SA40 ES-2RS	1,86
	28	24	45	92	M39x3	150	86	198	100	180	7	SA40 2RSC**	1,86
45	32	28	50	102	M42x3	163	92	217	127	240	7	SA45 ES	2,57
	32	28	50	102	M42x3	163	92	217	127	240	7	SA45 ES-2RS	2,57
	32	28	50	102	M42x3	163	92	217	127	240	7	SA45 C-2RS**	2,57
50	35	31	55	112	M45x3	185	104	246	156	290	6	SA50 ES	3,58
	35	31	55	112	M45x3	185	104	246	156	290	6	SA50 ES-2RS	3,58
	35	31	55	112	M45x3	185	104	246	156	290	6	SA50 C-2RS**	3,58
60	44	39	66	135	M52x3	210	115	282	245	450	6	SA60 ES	5,73
	44	39	66	135	M52x3	210	115	282	245	450	6	SA60 ES-2RS	5,73
	44	39	66	135	M52x3	210	115	282	245	450	6	SA60 C-2RS**	5,73
70	49	43	77	160	M56x4	235	125	318	315	610	6	SA70 ES	7,94
	49	43	77	160	M56x4	235	125	318	315	610	6	SA70 ES-2RS	7,94
	49	43	77	160	M56x4	235	125	318	315	610	6	SA70 C-2RS**	7,94
80	55	48	88	180	M64x4	270	140	365	400	750	6	SA80 ES	12,06
	55	48	88	180	M64x4	270	140	365	400	750	6	SA80 ES-2RS	12,06
	55	48	88	180	M64x4	270	140	365	400	750	6	SA80 C-2RS**	12,06

For left hand thread. Suffix "L" is added to bearings number and thread sign, eg. SAL30ES. Sliding contact surface: steel/steel. Available with increased thread

*The sizes are not binding.

**Sliding contact surface: steel/PTFE.

Rod ends for hydraulic components

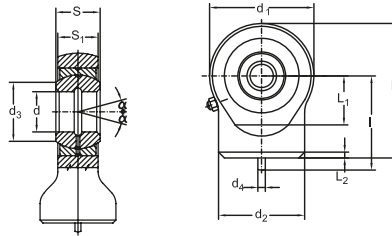

TAC...

Dimensions											Designation
d	S	d ₁	l	d ₂	d ₃	d ₄	S ₁	L	L ₁	L ₂	
mm											
10	9	29	24	15	13	3	7	38,5	14	2	TAC 210
12	10	34	27	17,5	15	3	8	44	16	2	TAC 212
15	12	40	31	21	18	4	10	51	18	2,5	TAC 215
17	14	46	35	24	20,5	4	11	58	20	3	TAC 217
20	16	53	38	27,5	24	4	13	65,4	23	3	TAC 220
25	20	64	45	33,5	29	4	17	77	27	4	TAC 225
30	22	73	51	40	34	4	19	87,5	30	4	TAC 230
35	25	82	61	47	39,5	4	21	102	37	4	TAC 235
40	28	92	69	52	45	4	23	115	44	5	TAC 240
45	32	102	77	58	50,5	6	27	128	48	5	TAC 245
50	35	112	88	62	56	6	30	144	58	6	TAC 250
60	44	135	100	70	66,5	6	38	167,5	68	8	TAC 260
70	49	160	115	80	77,5	6	42	195	78	10	TAC 270
80	55	180	141	95	89	6	47	231	91	10	TAC 280

Contact surface: steel / steel
The sizes are not binding.

Rod ends for hydraulic components

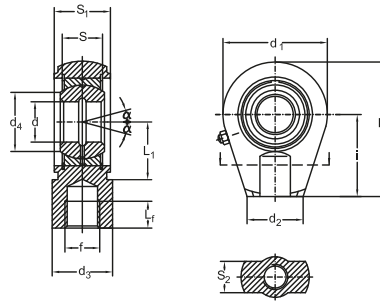

TAPR...N

Dimensions												Designation	
d	S	d ₁	l	L _f	d ₂	d ₃	d ₄	S ₁	S ₂	L	L ₁	f	
mm													-
20	16	56	50	17	36	25	24	19	17	80	25	M16x1,5	TAPR 420 N
25	20	56	50	17	36	25	29	23	21	80	28	M16x1,5	TAPR 425 N
30	22	64	60	23	40	32	34	28	26	94	30	M22x1,5	TAPR 430 N
35	25	78	70	29	50	40	39,5	30	28	112	38	M28x1,5	TAPR 435 N
40	28	94	85	36	60	49	45	35	33	135	45	M35x1,5	TAPR 440 N
50	35	116	105	46	72	61	56	40	37	168	55	M45x1,5	TAPR 450 N
60	44	130	130	59	90	75	66,5	50	46	200	65	M58x1,5	TAPR 460 N
70	49	154	150	66	100	86	77,5	55	51	232	75	M65x1,5	TAPR 470 N
80	55	176	170	81	125	102	89	60	55	265	80	M80x2	TAPR 480 N
90	60	206	210	101	146	124	98	65	60	323	90	M100x2	TAPR 490 N
100	70	230	235	111	166	138	109,5	70	65	360	105	M110x2	TAPR 495 N
110	70	265	265	125	190	152	121	80	75	407,5	115	M120x3	TAPR 496 N
120	85	340	310	135	257	172	135,5	90	85	490	140	M130x5	TAPR 497 N

Contact surface: steel / steel
The sizes are not binding.

Rod ends for hydraulic components

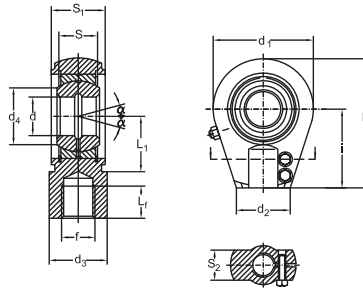

TAPR...U

Dimensions												Designation	
d	S	d ₁	l	L _f	d ₂	d ₃	d ₄	S ₁	S ₂	L	L ₁	f	
mm													-
20	16	56	50	17	36	25	24	19	17	80	25	M16x1,5	TAPR 520 U
25	20	56	50	17	36	25	29	23	21	80	28	M16x1,5	TAPR 525 U
30	22	64	60	23	40	32	34	28	26	94	30	M16x1,5	TAPR 530 U
35	25	78	70	29	50	40	39,5	30	28	112	38	M28x1,5	TAPR 535 U
40	28	94	85	36	60	49	45	35	33	135	45	M35x1,5	TAPR 540 U
50	35	116	105	46	72	61	56	40	37	168	55	M45x1,5	TAPR 550 U
60	44	130	130	59	90	75	66,5	50	46	200	65	M58x1,5	TAPR 560 U
70	49	154	150	66	100	86	77,5	55	51	232	75	M65x1,5	TAPR 570 U
80	55	176	170	81	125	102	89	60	55	265	80	M80x2	TAPR 580 U
90	60	206	210	101	146	124	98	65	60	323	90	M100x2	TAPR 590 U
100	70	230	235	111	168	138	109,5	70	65	360	105	M110x2	TAPR 595U
110	70	265	265	125	190	152	121	80	75	407,5	115	M120x3	TAPR 596 U
120	85	340	310	135	257	172	135	90	85	490	140	M130x5	TAPR 597 U

Contact surface: steel / steel
The sizes are not binding.

Rod ends for hydraulic components

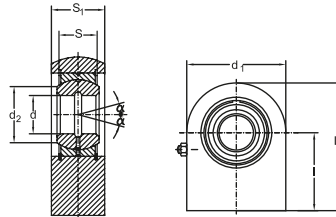

TPN...

Dimensions							Designation
d	S	d ₁	i	d ₂	S ₁	L	
mm							-
20	16	50	38	24	19	63	TPN 320
25	20	55	45	29	23	72,5	TPN 325
30	22	65	51	34	28	83,5	TPN 330
35	25	83	61	39,5	30	102,5	TPN 335
40	28	100	69	45	35	119	TPN 340
45	32	110	77	50,5	40	132	TPN 345
50	35	123	88	56	40	149,5	TPN 350
60	44	140	100	66,5	50	170	TPN 360
70	49	164	115	77,5	55	197	TPN 370
80	55	180	141	89	60	231	TPN 380
90	60	226	150	98	65	263	TPN 390
100	70	250	170	109,5	70	295	TPN 395
110	70	295	185	121	80	332,5	TPN 396
120	85	360	210	135,5	90	390	TPN 397

Contact surface: steel / steel
The sizes are not binding.

Rod ends for hydraulic components DIN 24555

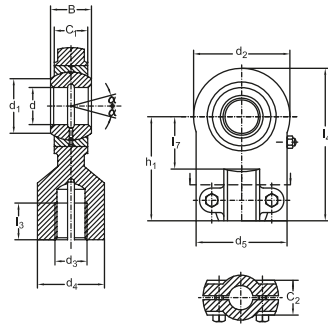

TAPR...DO

Dimensions													Designation
d	B	d ₂	d ₁	d ₃	d ₄	d ₅	C ₁	C ₂	h ₁	l ₃	l ₄	l ₇	
mm													-
12	10	32	15	M10x1,25	17	40	8	13	42	15	58	18	TAPR 701 DO
16	14	42	20	M12x1,25	21	45	11	13	48	17	69	22	TAPR 702 DO
20	16	50	25	M14x1,5	25	55	13	17	58	19	83	28	TAPR 703 DO
25	20	62	29	M16x1,5	30	62	-	68	23	99	34		TAPR 704 DO
30	22	76	34	M20x1,5	36	80	19	-	85	29	123	38	TAPR 705 DO
40	28	96	45	M27x2	45	90	23	-	105	37	153	48	TAPR 706 DO
50	35	116	55	M33x2	55	105	30	-	130	46	188	62	TAPR 707 DO
60	44	150	66	M42x2	68	134	38	-	150	57	255	74	TAPR 708 DO
80	55	195	88	M48x2	78	156	47	-	185	64	282,5	98	TAPR 709 DO
100	70	235	109	M64x3	100	190	57	-	240	86	357,5	122	TAPR 710 DO

Contact surface: steel / steel
The sizes are not binding.

Rod ends for hydraulic components

DIN 24338

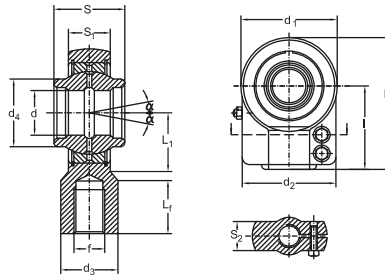

TAPR...CE

Dimensions												Designation	
d	S	d ₁	l	L _f	d ₂	d ₃	d ₄	S ₁	S ₂	L	L ₁	f	
mm													-
12	12	32	38	17	32	16	15,5	10,5	12	54	14	M12x1,25	TAPR 612 CE
16	16	40	44	19	40	21	20	13	11,5	64	18	M14x1,5	TAPR 616 CE
20	20	47	52	23	47	25	25	17	14	77	22	M16x1,5	TAPR 620 CE
25	25	58	65	29	54	30	30,5	21	17	96	27	M20x1,5	TAPR 625 CE
32	32	70	80	37	66	38	38	27	22	118	32	M27x2	TAPR 632 CE
40	40	89	97	46	80	47	46	32	26	145,5	41	M33x2	TAPR 640 CE
50	50	108	120	57	96	58	57	40	32	179	50	M24x2	TAPR 650 CE
63	63	132	140	64	114	70	71,5	52	38	211	62	M48x2	TAPR 663 CE
70	70	155	160	76	135	80	79	57	42	245	70	M56x2	TAPR 670 CE
80	80	168	180	86	148	90	91	66	48	270	78	M64x3	TAPR 680 CE
90	90	185	195	91	160	100	99	72	52	296	85	M72x3	TAPR 690 CE
100	100	210	210	96	178	110	113	84	62	322	98	M80x3	TAPR 695 CE
110	110	235	235	101	190	125	124	88	62	364	105	M90x3	TAPR 696 CE
125	125	264	260	106	200	135	138	103	72	405	120	M100x3	TAPR 697 CE

Contact surface: steel / steel
The sizes are not binding.

Rod ends

ISO 6126 - 1982

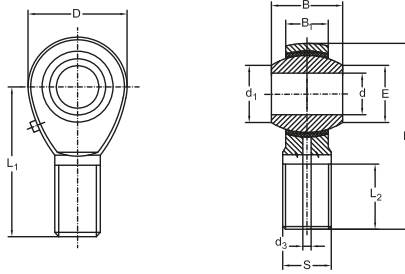

POS
POS...EC

Dimensions									Load ratings		Designation	Mass	
d	d ₁	B ₁	E	B	D	S	L ₁	L ₂	dyn.	stat.	-	kg	
mm										kN	kN	-	kg
5	7,7	8	11,11	7	16	M5x0,8	33	20	3,2	7	POS5*	0,014	
	7,7	8	11,11	7,5	18	M5	33	20	3,2	7	POS5 EC**	0,014	
6	9	9	12,70	7	18	M6x1	36	22	3,5	8	POS6*	0,019	
	8,9	9	12,70	7,5	20	M6	36	22	3,5	8	POS6 EC**	0,019	
8	10,4	12	15,88	9	22	M8x1,25	42	25	5,8	13	POS8*	0,036	
	10,3	12	15,88	9,5	24	M8	42	25	5,8	13	POS8 EC**	0,036	
10	12,9	14	19,05	11	26	M10x1,5	48	29	8,6	18	POS10*	0,060	
	12,9	14	19,05	11,5	30	M10	48	29	8,6	18	POS10 EC**	0,070	
12	15,4	16	22,23	12	30	M12x1,75	54	33	11,5	24	POS12*	0,089	
	15,4	16	22,23	12,5	34	M12	54	33	11,5	24	POS12 EC*	0,110	
14	16,9	19	25,40	14	34	M14x2	60	36	17,5	36	POS14*	0,129	
	16,8	19	25,40	14,5	38	M14	60	36	17,5	36	POS14 EC**	0,130	
16	19,4	21	28,58	15	38	M16x2	66	40	20	40	POS16*	0,181	
	19,3	21	28,58	15,5	42	M16	66	40	20	40	POS16 EC**	0,220	
17	20,6	22	30,16	16	40	M16x1,5	69	42	22	45	POS17*	0,206	
18	21,9	23	31,75	17	42	M18x1,5	72	44	27	50	POS18*	0,250	
	21,8	23	31,75	17,5	46	M18x1,5	72	44	27	50	POS18 EC**	0,290	
20	24,4	25	34,93	18	46	M20x1,5	78	47	31	60	POS20*	0,333	
	24,3	25	34,93	18,5	50	M20x1,5	78	47	31	60	POS20 EC**	0,360	
22	25,9	28	38,10	20	50	M22x1,5	84	51	43	72	POS22*	0,430	
	25,8	28	38,1	21	56	M22x1,5	84	51	43	72	POS22 EC**	0,490	
25	29,5	31	42,86	22	56	M24x2	94	57	50	85	POS25*	0,575	
	29,5	31	42,86	23	60	M24x2	94	57	50	85	POS25 EC**	0,65	
28	32,3	35	47,59	25	66	M27x2	103	62	60	90	POS28*	0,800	
	32,2	35	47,59	26	66	M27x2	103	62	60	90	POS28 EC**	0,870	
30	34,9	37	50,80	26	67	M30x2	110	66	66	110	POS30*	0,996	
	34,8	37	50,80	27	70	M30x2	110	66	66	110	POS30 EC**	1,060	

*For left hand thread, suffix "L" is added to bearings number and thread sign, eg. TSML. Sliding contact surface: steel/steel. Available with increased thread. Sliding contact surface: steel/bronze.

**For left hand thread, suffix "L" is added to bearings number and thread sign, eg. TSML...C. Sliding contact surface: steel/steel. Available with increased thread. Sliding contact surface: steel/PTFE. The sizes are not binding.

Rod ends

ISO 6126 - 1982

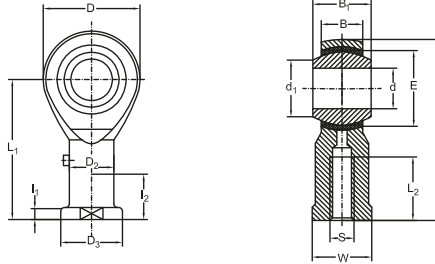

PHS
PHS...EC

Dimensions											Load ratings		Designation	Mass		
d	d ₁	B ₁	E	B	D	S	L ₁	L ₂	D ₂	D ₃	I ₁	W	dyn.	stat.	-	kg
mm													kN	kN	-	kg
5	7,7	8	11,11	7	16	M5x0,8	27	8	9	12	4	9	3,2	7	PHS5	0,018
	7,7	8	11,11	7,5	18	M5	27	8	9	12	4	10	3,2	7	PHS5 EC	0,018
6	9,0	9	12,71	7	18	M6x1	30	9	10	13	5	11	3,5	8	PHS6	0,026
	8,9	9	12,71	7,5	20	M6	30	9	10	13	5	10	3,5	8	PHS6 EC	0,026
8	10,4	12	15,88	9	22	M8x1,25	36	12	12,5	16	5	14	5,8	13	PHS8	0,045
	10,3	12	15,88	9,5	24	M8	36	12	12,5	16	5	13	5,8	13	PHS8 EC	0,045
10	12,9	14	19,05	11	26	M10x1,5	43	15	15	19	6,5	17	8,6	18	PHS10	0,076
	12,9	14	19,05	11	26	M10x1,25	43	15	15	19	6,5	17	8,6	18	PHS10,1	0,076
	12,9	14	19,05	11,5	30	M10	43	15	15	19	6,5	16	8,6	18	PHS10 EC	0,088
	12,9	14	19,05	11,5	30	M10x1,25	43	15	15	19	6,5	16	8,6	18	PHS10,1 EC	0,088
12	15,4	16	22,23	12	30	M12x1,75	50	18	17,5	22	6,5	19	11,5	24	PHS12	0,114
	15,4	16	22,23	12	30	M12x1,25	50	18	17,5	22	6,5	19	11,5	24	PHS12,1	0,114
	15,4	16	22,23	12,5	34	M12	50	18	17,5	22	6,5	18	11,5	24	PHS12 EC	0,120
	15,4	16	22,23	12,5	34	M12x1,25	50	18	17,5	22	6,5	18	11,5	24	PHS12,1 EC	0,120
14	16,9	19	25,40	14	34	M14x2	57	21	20	25	8	22	17,5	36	PHS14	0,158
	16,8	19	25,40	14,5	38	M14	57	21	20	25	8	21	17,5	36	PHS14 EC	0,140
16	19,4	21	28,58	15	38	M16x2	64	24	22	27	8	22	20	40	PHS16	0,200
	19,4	21	28,58	15	38	M16x1,5	64	24	22	27	8	22	20	40	PHS16,1	0,200
	19,3	21	28,58	15,5	42	M16	64	24	22	27	8	24	20	40	PHS16 EC	0,240
	19,3	21	28,58	15,5	42	M16x1,5	64	24	22	27	8	24	20	40	PHS16,1 EC	0,240
17	20,6	22	30,16	16	40	M16x1,5	67	25	24	31	10	27	22	45	PHS17	0,259
18	21,9	23	31,75	17	42	M18x1,5	71	27	25	31	10	27	27	50	PHS18	0,288
	21,8	23	31,75	17,5	46	M18	71	27	25	31	10	27	27	50	PHS18 EC	0,320
20	24,4	25	34,93	18	46	M20x1,5	77	30	27,5	37	10	30	31	60	PHS20	0,372
	24,3	25	34,93	18,5	50	M20	77	30	27,5	37	10	30	31	60	PHS20 EC	0,430
22	25,9	28	38,10	20	50	M22x1,5	84	33	30	37	12	32	43	72	PHS22	0,475
	25,8	28	38,10	21	56	M22	84	33	30	37	12	34	43	72	PHS22 EC	0,610
	29,6	31	42,86	22	56	M24x2	94	36	33,5	42	12	36	50	85	PHS25	0,673
25	29,5	31	42,86	23	60	M24	94	36	33,5	42	12	36	50	85	PHS25 EC	0,810
28	32,3	35	47,59	25	66	M27x2	103	41	37	46	14	41	60	90	PHS28	0,950
	32,2	35	47,59	26	66	M27	103	41	37	46	14	41	60	90	PHS28 EC	1,120
30	34,9	37	50,80	26	67	M30x2	110	45	40	50	15	41	66	110	PHS30	1,050
	34,8	37	50,80	27	70	M30	110	45	40	50	15	46	66	110	PHS30 EC	1,350

Spherical plain bearings

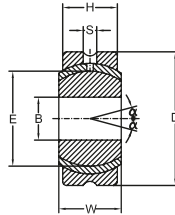

SSR

Dimensions									Max static load ratings		Designation	Mass
B	W	H	O	D	R	S	E	α	dyn.	stat.	-	kg
mm									kN	kN	-	kg
5	8	7	7,71	16	0,5	1,5	11,11	24	9,30	2,30	SSR5	0,010
6	9	7	8,96	18	0,5	1,5	12,7	28	10,70	2,70	SSR6	0,012
8	12	9	10,4	22	0,5	1,5	15,88	25	17,20	4,30	SSR8	0,024
10	14	11	12,92	26	0,5	1,5	19,05	23	25,10	6,30	SSR10	0,040
12	16	12	15,43	30	1	2	22,23	24	32,00	8,00	SSR12	0,058
14	19	14	16,86	34	1	2	25,4	23	42,70	10,70	SSR14	0,086
15	20	14	18,2	36	1	2	26,99	24	45,30	11,30	SSR15	0,098
16	21	15	19,39	38	1	2	28,58	24	51,40	12,90	SSR16	0,116
17	22	16	20,63	40	1	2,5	30,16	23	57,90	14,50	SSR17	0,135
18	23	17	21,89	42	1,5	2,5	31,75	23	64,80	162,0	SSR18	0,157
20	25	18	24,38	46	1,5	2,5	34,93	24	75,40	18,90	SSR20	0,200
22	28	20	25,84	50	1,5	2,5	38,1	23	91,40	22,90	SSR22	0,262
25	31	22	29,6	56	1,5	3	42,86	23	113,20	28,30	SSR25	0,362
28	35	25	32,29	62	1,5	3	47,83	22	142,90	35,70	SSR28	0,500
30	37	26	34,81	67	2	3	50,8	23	158,50	39,60	SSR30	0,608

Materials: - housing - steel
 - insert - bronze
 - ball - chrome steel

The sizes are not binding.

Ball joint rod end with spring clamping

DIN 71802

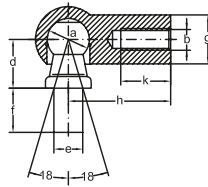

B

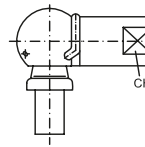

BS

Dimensions								Mass	
a	b	d	e	f	g	h	k	CH*	B and BS
H9/h8			h11						
mm								-	kg
8	M5	9	5	4	8	22	10,2	7	12,85
8	M5	9	5	7,5	8	22	10,2	7	13,35
10	M6	11	6	4,5	10	25	11,5	8	21,3
10	M6	11	6	8	10	25	11,5	8	22
13	M8	13	8	5	13	30	14	11	43,2
13	M8	13	8	10	13	30	14	11	45
16	M10	16	10	6	16	35	15,5	13	82,3
16	M10	16	10	13	16	35	15,5	13	86,6
19	M14x1,5	20	14	12	22	45	21,5	17	181
19	M14x2	20	14	18	22	45	21,5	17	188,7

Surface: zinc - plating FeZN7 Uni 4721 - or coarse oiled surface by request.

*Clamping plains.

C45 special.

The sizes are not binding.

Ball joint rod end with spring clamping and safety ring

DIN 71802

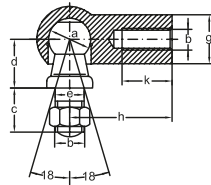

A

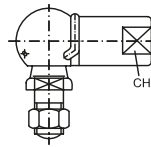

AS

Dimensions

a	b	c	d	e	g	h	L ₁	L ₂	k	CH*	Mass
H9/h8				h11							A and AS
mm											g
8	M5	10	9	5	8	22	25,2	28,5	10,2	7	15,2
10	M6	12	11	6	10	25	30,2	32,5	11,5	8	25,2
13	M8	16	13	8	13	30	38,2	39,5	14	11	53,1
16	M10	19	16	10	16	35	47,5	47	15,5	13	102,8
19	M14x1,5	27	20	14	22	45	62,5	60	21,5	17	220,9
19	M14x2	27	20	14	22	45	62,5	60	21,5	17	220,9

Surface: zinc - plating FeZN7 Uni 4721 - or coarse oiled surface by request.

*Clamping plains.

C45 special.

The sizes are not binding.

ART BEARINGS



Linear ball bearings bushing

Load Rating

Basic dynamic load rating

This term is arrived at based on an evaluation of a number of identical linear systems individually run in the same conditions, if 90% of them can run with the load with a constant value in a constant direction) for a distance of 50 km without damage caused by rolling fatigue. This is the basis of the rating.

Allowable static moment

This term defines the allowable limit value of static moment load with reference to the amount of permanent deformation similar to that used for evaluation of basic rated load (Co).

Static safety factor

This factor is used based on the application condition as shown in Table 1.

Basic static load rating

This term defines a static load such that, at the contacting position where the maximum stress is exercised, the sum of the permanent deformation of the rolling elements and that of the rolling plane is 0,0001 time of the diameter of the rolling elements.

Static safety factors	
Condition of use	Low limit of fs
When the shaft has less deflection and shock	1 to 2
When elastic deformation should be considered with respect to pinch load	2 to 4
When the equipment is subject to vibration and impacts	3 to 5

Table 1

Rating life

Rating life of the linear system

As long as linear system reciprocates while being loaded, continuous stress acts on the linear system to cause flaking on the rolling bodies and planes because of material fatigue. The travelling distance of linear system until the first flaking occurs is called the life of the system. The life of the dimensions, structure, material, heat treatment and processing method, when used in the same conditions. This variation is brought about from the essential variations in the material fatigue itself. The rating life defined below is used as an index for the life expectancy of the linear system.

Rating life

Rating life is the total travelling distance that 90% of a group of systems of the same size can reach without causing any flaking when they operate under the same conditions.

The rating life can be obtained from the following equation with the basic dynamic load rating and the load on the linear system:

For ball type:

$$L = \left(\frac{C}{P}\right)^3 \times 50$$

where:

- L - rating life, km,
- C - basic dynamic load rating, N,
- P - load, N.

Consideration and influence of vibration impact loads and distribution of load should be taken into account when designing a linear motion system. It is difficult to calculate the actual load.

The rating life is also affected by the operating temperature. In these conditions, the expression (1) is arranged as follows:

For ball type:

$$L = \left(\frac{f_H^3 \times f_r \times f_c}{f_w \times P} \right) \times 50$$

where:

- L - rating life, km,
- f_H - hardness factor (see figure 1),
- C - basic dynamic load rating, N,
- f_T - temperature coefficient (see figure 2),
- P - load, N,
- f_C - contact coefficient (see table 2),
- f_W - load coefficient (see table 3).

The rating life in hours can be calculated by obtaining the travelling distance per unit time. The rating life in hours can be obtained from the following expression when the stroke length and the number of strokes are constant:

$$L_h = \frac{L \times 10^3}{2 l_s \times n_1 \times 60}$$

where:

- L_h - rating life in hours, hr,
- l_s - stroke length, m
- L - rating life, km,
- n_1 - no of trokes per minute, cpm.

Hardness factor

The shaft be sufficiently hardened when a linear bushing is used. If not properly hardened, permissible load is lowered and the life of the bushing will be shortened



Fig. 1

Temperature coefficient

If the temperature of the linear system exceeds 100°C, Hardness of the linear system and the

shaft lowers to decrease the permissible load compared to that of the linear system used at room temperature rise shortens the rating life.

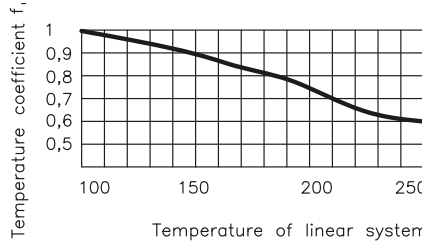

Fig. 2

Contact coefficient

Generally two or more linear bushing are used on one shaft. Thus, the load on each linear system differs depending on each precessing accuracy. Because the linear bushing are not loaded equally, the number of linear bushing per shaft changes the permissible load of system.

Contact coefficient	
Table 2	
Number of linear system per shaft	Contact coefficient f_c
1	1,00
2	0,81
3	0,72
4	0,66
5	0,61

Load coefficient

When calculating the load on the linear system, it is necessary to accurately obtain object weight, inertial force based on motion speed, moment load, and each transition as time passes. However, it is difficult to calculate those values accurately because reciprocating motion involves the repetition of start and stop as well as vibration and impact. A more practical approach is to obtain the load coefficient by taking the actual operating conditions into account.

Load coefficient		Table 3
Operating Conditions	f_w	
Operation at low speed (15 m/min. or less) without impulsive shock from outside	1,0 to 1,5	
Operation at intermediate speed (60 m/min. or less) without impulsive shock	1,5 to 2,0	
Operation at high speed (over 60 m/min.) with impulsive shock from outside	2,0 to 3,5	

Frictional resistance

The static frictional resistance of the ART linear system is so low as to be only slightly different from the kinetic frictional resistance, enabling smooth linear movement from low to high speeds. In general, the friction resistance is expressed by the following equation.

$$F = \mu W + f$$

where:

- F - frictional resistance,
- μ - coefficient of friction,
- W - load weight,
- f - sealing resistance.

The frictional resistance of each ART linear system depends on the model, load weight, speed, and lubricant. The sealing resistance depends on lip interference and lubricant, regardless of the load weight. The sealing resistance of one linear system is about 200 to 500 gf. The coefficient of friction depends on the load weight, moment load, and preload. Table 6 shows the coefficient of kinetic friction of each type of linear system which has been installed and lubricated properly and applied with normal load ($P/C=0,2$)

Coefficient of linear system friction			Table 4
Linear System Type	Models	Ambient Working Temperature	
Linear Bushing	LM LME LMB	0,002 to 0,003	

Ambient working temperature

The ambient working temperature range for each ART linear system depends on the model. Consult ART on use outside the recommended temperature range.

Temperature conversion equation:

$$C = \frac{5}{9}(F - 32)$$

$$F = 32 + \frac{9}{5}C$$

Ambient working temperature			Table 5
Linear System Type	Models	Ambient Working Temperature	
Linear Bushing	LM LME LMB	-20 to 80°C	

Lubrication and dust prevention

Using ART linear systems without lubrication increases the abrasion of the rolling elements, shortening the life span. The ART linear systems, therefore require appropriate lubrication. For lubrication ART recommends turbine oil conforming to ISO Standards G32 to G68 or lithium base soap grease no. 2. Some ART linear systems are sealed to block dust out and seal lubricant in. If used in a harsh or corrosive environment, however, apply a protective cover to the part involving linear motion.

Structure and features

The ART linear bushing consists of an outer cylinder, ball retainer, balls and two end rings. The ball retainer which holds the balls, in the recirculating trucks inheld inside the outer cylinder by end rings.

Those parts are assembled to optimize their performance. The surface finish is maintained sufficient

hardness by heat treatment, therefore it ensures the bushings projected travel life and satisfactory durability.

The ball retainer is made from synthetics to reduce running noise.

High precision and rigidity

The URB linear bushing is reduced from a solid steel outer cylinder and incorporates an industrial strength resin retainer.

Ease of assembly

The standard type of URB linear bushing can be loaded from any direction. Precision control is possible using only the shaft supporter, and the mounting surface can be machined easily.

Ease of replacement

URB linear bushing of each type are completely interchangeable because of their standardized dimensions and strict precision control. Replacement because of wear or damage is therefore easy and accurate.

Variety of types

URB offers a full line of linear bushing: The standard, integral single - retainer closed type, the clearance adjustable type and the open type. The user can choose from among these according to the application requirements to be met.

Linear ball bushing designation

Designation			
Group I	Group II	Group III	Group IV
Type	Nominal shaft diameter	Modification	Seal

Example:
LM 25 UU AJ

Type:

LM - metric dimension series most widely used in Japan,

LME - metric dimension series generally used in Europe,

LMB - inch dimension series used mainly in USA.

Modification:

No entry - standard type,

AJ - adjustable type,

OP - open type.

Seal:

No entry - no seal,

U - seal on one side,

UU - seals on both sides.

Tolerance

Note that precision of inscribed circle diameters and outside diameters for the clearance adjustable type (...AJ) and the open type (...OP) indicates the value obtained before the corresponding type is subjected to cutting process.

Load rating and life expectancy

The life of a linear bushing can be obtained from the following equation with the basic dynamic load rating and the load applied to the bush:

$$L = \left(\frac{f_H \times f_T \times f_C}{f_w \times P} \times \frac{C}{P} \right)^3 \times 50$$

where:

L - rated life, km,

C - basic dynamic load rating, N

P - working load, N,

f_w - load coefficient,

f_H - hardness factor (see page 607),

f_T - temperature coefficient (see page 607),

f_C - contact coefficient (see page 607).

The lifespan of a linear bushing in hours can be obtained by calculating the travelling distance per unit time.

The lifespan can be obtained from the following equation if the stroke length and the number of strokes are constant:

$$L_h = \left(\frac{L \times 10^3}{2 \times l_s \times n_1 \times 60} \right)$$

where:

L_h - lifespan, hr,

l_s - stroke length, m,

L - rated life, km,

n_1 - number of strokes per minute, cpm.

Relation between ball circuits and load rating

The URB linear bushing includes ball circuits that are spaced equally and circumferentially. The load rating varies according to the loaded position on the circumference.

The value in the dimension table indicates the load rating when the load is placed on top of one ball circuit. If the URB linear bushing is used with

two ball circuits loaded uniformly, the load rating will be greater. The following table shows the values by the number of ball circuits in such cases:

Row position load ratio	Number of rows				
	3	4	5	6	8
Row position load ratio $Q_i = P_0$	 $Q_i = P_0$	 $Q_i = 1,106P_0$	 $Q_i = 1,1354P_0$	 $Q_i = 1,841P_0$	
Row position $Q_0 = P_0$	 $Q_0 = 1,414P_0$	 $Q_0 = 1,618P_0$	 $Q_0 = 1,732P_0$	 $Q_0 = 2,052P_0$	
Load ratio $Q_0/Q_i = 1$	$Q_0/Q_i = 1,414$	$Q_0/Q_i = 1,463$	$Q_0/Q_i = 1,280$	$Q_0/Q_i = 1,115$	

Sample calculations

Obtaining the rated life and lifespan the URB linear bushing used in the following conditions:

Linear bushing	LM20
Stroke length	50 mm
Number of strokes per minute	50 cpm
Load per bush	490 N

The basic dynamic load rating of the linear bushing is 882N from the dimension table. From equation (1) therefore, the rated life is obtained as follows:

$$L = \left(\frac{f_H \times f_T \times f_C}{f_W \times P} \times \frac{C}{P} \right)^3 \times 50 = \left(\frac{882^3}{490^3} \right) \times 50 = 292 \text{ km,}$$

where:

$$f_H = f_T = f_C = f_W = 1.0$$

From equation (2), the lifespan is obtained as follows:

$$L_h = \left(\frac{L \times 10^3}{2 \times l_s \times n_1 \times 60} \right) = \left(\frac{292 \times 10^3}{2 \times 0,05 \times 50 \times 60} \right) = 973 \text{ hr}$$

Selecting the linear bushing type satisfying the following conditions:

Number of linear bushing used	4
Stroke length	1 m
Traveling speed	10 m/min
Number of strokes per minute	5 cpm
Lifespan	10 hr
Total load	980 N

From equation (2), the travelling distance within the lifespan is obtained as follows

$$L = 2 \times l_s \times n_1 \times 60 \times L_h = 6000 \text{ km}$$

From equation (1), the basic dynamic load rating is obtained as follows:

$$C = \sqrt[3]{\frac{L}{50}} \times \left(\frac{f_W}{f_H + f_T + f_C} \right) \times P = 1492 \text{ N}$$

Assume the following with a pair of shafts each with two linear bushing:

$$f_C = 0,81, f_W = f_T = f_H = 1$$

As a result, LM30 is selected from the dimension table as the URB linear bushing type satisfying the value of C.

Clearance and fit

When a standard-type ART linear bushing is used with a shaft, inadequate clearance, adjustment may cause early bush failure and/or poor, rough traveling.

The clearance adjustable linear bush and open linear bush can be clearance adjusted when assembled in the housing which can control the outside cylinder diameter. However, too much clearance adjustment increases the deformation of the outside cylinder, to affect its precision and life. Therefore, the appropriate clearance between the bush and shaft, and clearance between the bush and housing are required according to the application. Table 7 shows recommended fit of the bush:

Division Model	Shaft	Transitional	Housing	
	Normal fit High class		Loose fit	Tight fit
LM LMB	g6	h6	H7	J7
LME	h6	j6	H7	J7

Note. The clearance may be zero or negative. Please attention the movement.

Shaft and housing

To optimize performance of the ART linear bushing high precision of the shaft and housing is required.

Shaft

The rolling balls in the ART linear bushing are in point contact with the shaft surface. Therefore, the shaft dimensions, tolerance, surface finish and hardness greatly affect the travelling performance of the bush. The shaft should be manufactured with due attention to the following points:

- Since the surface finish critically affects smooth rolling of balls, grind the shaft at 1,5 S or better.
- The best hardness of the shaft is HRC 60 to 64; Hardness less than HRC 60 decreases the life considerably, and hence reduces the permissible load. On the other hand, hardness over HRC 64 accelerates ball wear.
- The shaft diameter for the clearance adjustable linear bush and open linear bush should as much as possible be of the lower value of the inscribed

circle diameter in the specification table. Do not set the shaft diameter to the upper value.

- Zero clearance or negative clearance increases the frictional resistance slightly. If the negative clearance is too tight, the deformation of the outside cylinder will become larger, to shorten the bush life.

Housing

There is a wide range of housing differing in design, machining and mounting. For the fitness and shapes of housing see in table 8 and the following section on mounting.

Mounting

When inserting the linear bush into the bushing do not hit the linear bush on the side ring holding the retainer but apply the cylinder circumference with a proper jig and push the linear bush into the housing by hand or lightly knock it in. In inserting the shaft after mounting the bush, be careful not to shock the balls. Note that if two shafts are used in parallel, the parallelism is the most important factor to assure the smooth linear movement. Take care in setting the shafts.

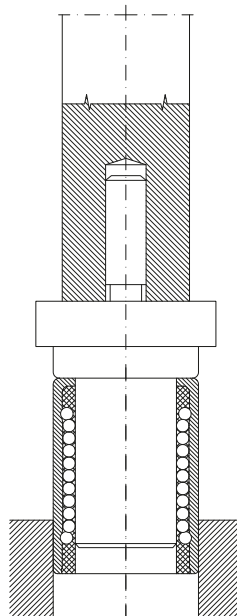

Examples of mounting

The popular way to mount a linear bush is to operate it with an appropriate interference. It is recommended, however, to make a loose fit in principle because otherwise precision is apt to be minimized. The following examples show assembling of the inserted bush in terms of designing and mounting for reference.

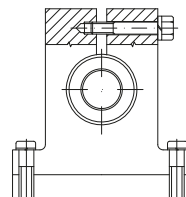
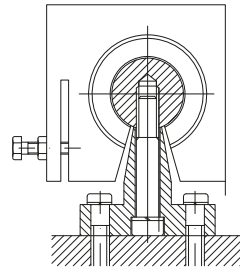
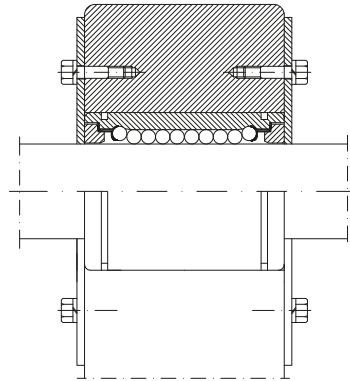
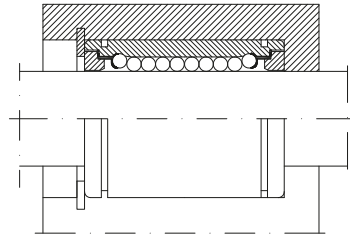
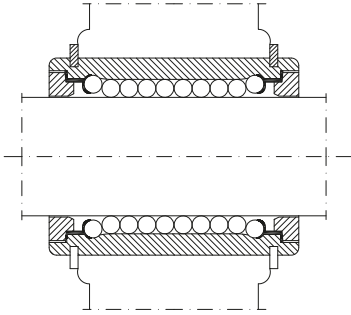

ART ball bushing interchangeability list

Ball bushing compact type

ART	NTN	STAR	INA	SKF	FAG
KH...	KH...	0658 - 0... -00	KH...	LBBR...	LNA...
				LBBS...	LFA
KH... PP	KH...LL	0658 - 2... -40	KN...PP	LBBR...2LS	LNA...2RS
				LBBS...2LS	LFA...2RS

Ball bushing resin retainer

ART	NB	INA	SKF	THK	IKO	THOMSON	EASE
LME	KB...G	KB	LBAR/LBCR	LME...	LBE...	MA M...	SDE
LME...UU	KB...GUU	KB...PP	LBAR/LBCR...2LS	LME...UU	LBE...UU	MA M...WW	SDE...UU
LME...AJ	KB...GAJ	KBS...	LBAS...	LME...AJ	LBE...AJ	MA M...ADJ	SDE...AJ
LME...UUAJ	KB...GUUAJ	KBS...PP	LBAS...2LS	LME...UUAJ	LBE...UUAJ	MA M...ADJ WW	SDE...UUAJ
LME...OP	KB...GOP	KBO...	LBAT/LBCT...	LME...OP	LBE...OP	MA M...OPN	SDE...OP
LME...UUOP	KB...GUUOP	KBO...PP	LBAT/LBCT...2LS	LME...UUOP	LBE...UUOP	MA M...OPN WW	SDE...UUOP

The above types are metric dimension series generally used in Europe.

ART	NB	THK	EASE	ART	NB	THK	EASE
LM	SM...G	LM...	SDM	LMB	SW...G	LMB...	SDB
LM...UU	SM...GUU	LM...UU	SDM...UU	LMB...UU	SW...GUU	LMB...UU	SDB...UU
LM...AJ	SM...GAJ	LM...AJ	SDM...AJ	LMB...AJ	SW...GAJ	LMB...AJ	SDB...AJ
LM...UUAJ	SM...GUUAJ	LM...UUAJ	SDM...UUAJ	LMB...UUAJ	SW...GUUAJ	LMB...UUAJ	SDB...UUAJ
LM...OP	SM...GOP	LM...OP	SDM...OP	LMB...OP	SW...GOP	LMB...OP	SDB...OP
LM...UUOP	SM...GUUOP	LM...UUOP	SDM...UUOP	LMB...UUOP	SW...GUUOP	LMB...UUOP	SDB...UUOP

The above types are metric dimension series generally used in Japan and other countries.

The above types are inch dimension series generally used in US.

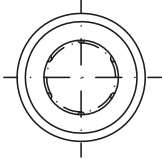
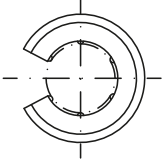
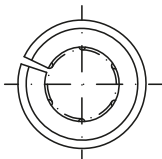
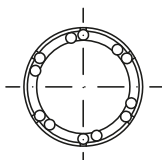
<p>Standard type</p>  <p>page 615 - 620</p>	
<p>Open type</p>  <p>page 615 - 620</p>	<p>One ball circuit (50° - 80°) is removed to allow an opening slot to fit over rail supports.</p>
<p>Adjustable type</p>  <p>page 615 - 620</p>	<p>This type has a slot in the outside cylinder. This design allows for clearance adjustment.</p>
<p>Drawn cup type</p>  <p>page 621</p>	<p>This type linear ball bushing consist of thin walled drawn cups, plastic cages and grade 10 steel balls. Bushings are available with seals at one or both ends.</p>

Linear ball bushing

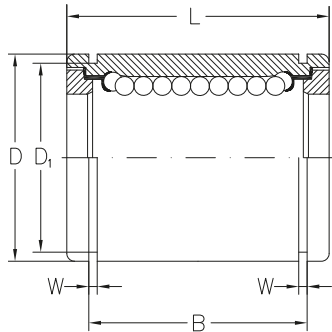

Nominal part no.						Nominal shaft diameter
Standard type	Seal type	Ball circuit	Mass	Adjustable type	Open type	Tolerance
-	-		gr	-	-	mm
LM5	LM5 UU	4	4	-	-	5 ⁰ _{-0,008}
LM6	LM6 UU	4	8	LM6 AJ	-	6 ⁰ _{-0,009}
LM8 S	LM8 SUU	4	11	LM8 SAJ	-	8
LM8	LM8 UU	4	16	LM8 AJ	-	8
LM10	LM10 UU	4	30	LM10 AJ	-	10
LM12	LM12 UU	4	31,5	LM12 AJ	LM12 OP	12
LM13	LM13 UU	4	43	LM13 AJ	LM13 OP	13
LM16	LM16 UU	4	69	LM16 AJ	LM16 OP	16
LM20	LM20 UU	5	87	LM20 AJ	LM20 OP	20 ⁰ _{-0,010}
LM25	LM25 UU	6	220	LM25 AJ	LM25 OP	25
LM30	LM30 UU	6	250	LM30 AJ	LM30 OP	30
LM35	LM35 UU	6	390	LM35 AJ	LM35 OP	35 ⁰ _{-0,012}
LM40	LM40 UU	6	585	LM40 AJ	LM40 OP	40
LM50	LM50 UU	6	1580	LM50 AJ	LM50 OP	50
LM60	LM60 UU	6	2000	LM60 AJ	LM60 OP	60 ⁰ _{-0,015}

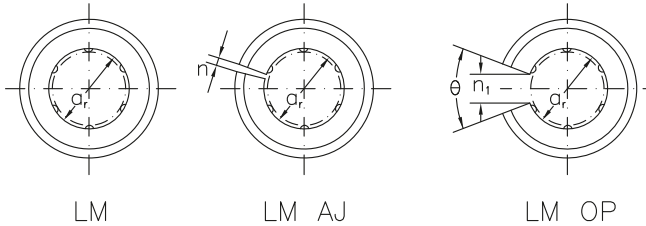

Major dimensions and tolerance

D _{Tolerance}	L _{Tolerance}	B _{Tolerance}	W	D1	H	h1		Eccen- tricity max	Radial clearance max	Basic load C	Rating C ₀	Nominal part no.
mm								μm		kN		
10 ⁰ _{-0,009}	15 ⁰ _{-0,012}	10,2 ⁰ _{-0,2}	1,1	9,6	-	-	-	8	-3	0,17	0,21	LM5
12 ⁰ _{-0,011}	19 ⁰ _{-0,02}	13,5 ⁰ _{-0,2}	1,1	11,5	1	-	-	12	-5	0,21	0,27	LM6
15 ⁰ _{-0,011}	17 ⁰ _{-0,02}	11,5 ⁰ _{-0,2}	1,1	14,3	1	-	-	12	-5	0,18	0,23	LM8S
15 ⁰ _{-0,011}	24 ⁰ _{-0,02}	17,5 ⁰ _{-0,2}	1,1	14,3	1	-	-	12	-5	0,27	0,41	LM8
19 ⁰ _{-0,013}	29 ⁰ _{-0,02}	22 ⁰ _{-0,2}	1,3	18	1	-	-	12	-5	0,38	0,56	LM10
21 ⁰ _{-0,013}	30 ⁰ _{-0,02}	23 ⁰ _{-0,2}	1,3	20	1,5	8	80°	12	-5	0,42	0,61	LM12
23 ⁰ _{-0,013}	32 ⁰ _{-0,02}	23 ⁰ _{-0,2}	1,3	22	1,5	9	80°	12	-7	0,52	0,79	LM13
28 ⁰ _{-0,013}	37 ⁰ _{-0,02}	26,5 ⁰ _{-0,2}	1,6	27	1,5	11	80°	12	-7	0,79	1,2	LM16
32 ⁰ _{-0,016}	42 ⁰ _{-0,02}	30,5 ⁰ _{-0,2}	1,6	30,5	1,5	11	60°	15	-9	0,88	1,4	LM20
40 ⁰ _{-0,016}	59 ⁰ _{-0,03}	41 ⁰ _{-0,3}	1,85	38	2	12	50°	15	-9	1	1,6	LM25
45 ⁰ _{-0,016}	64 ⁰ _{-0,03}	44,5 ⁰ _{-0,3}	1,85	43	2,5	15	50°	15	-9	1,6	2,8	LM30
52 ⁰ _{-0,019}	70 ⁰ _{-0,03}	49,5 ⁰ _{-0,3}	2,1	49	2,5	17	50°	20	-13	1,7	3,2	LM35
60 ⁰ _{-0,019}	80 ⁰ _{-0,03}	60,5 ⁰ _{-0,3}	2,1	57	3	20	50°	20	-13	2,2	4,1	LM40
70 ⁰ _{-0,022}	100 ⁰ _{-0,03}	74 ⁰ _{-0,3}	2,6	76,5	3	25	50°	20	-13	3,9	8,1	LM50
80 ⁰ _{-0,022}	110 ⁰ _{-0,03}	85 ⁰ _{-0,3}	3,15	86,5	3	30	50°	25	-16	4,8	10,2	LM60

LM < Built-in synthetic resin retainers >

This type is a metric dimension series widely used in Japan and other countries.

Linear ball bushing

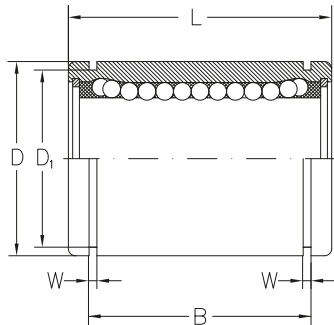

Nominal part no.						Nominal shaft diameter
Standard type	Seal type	Ball circuit	Mass	Adjustable type	Open type	Tolerance
-	-		gr	-	-	mm
LME5	LME5 UU	3	11	LME5 AJ	-	$5^{+0,008}_0$
LME8	LME8 UU	4	20	LME8 AJ	-	8
LME12	LME12 UU	4	41	LME12 AJ	LME12 OP	12
LME16	LME16 UU	4	57	LME16 AJ	LME16 OP	$16^{+0,009}_{-0,001}$
LME20	LME20 UU	5	91	LME20 AJ	LME20 OP	20
LME25	LME25 UU	6	215	LME25 AJ	LME25 OP	$25^{+0,011}_{-0,001}$
LME30	LME30 UU	6	325	LME30 AJ	LME30 OP	30
LME40	LME40 UU	6	705	LME40 AJ	LME40 OP	$40^{+0,013}_{-0,002}$
LME50	LME50 UU	6	1130	LME50 AJ	LME50 OP	50
LME60	LME60 UU	6	2220	LME60 AJ	LME60 OP	60

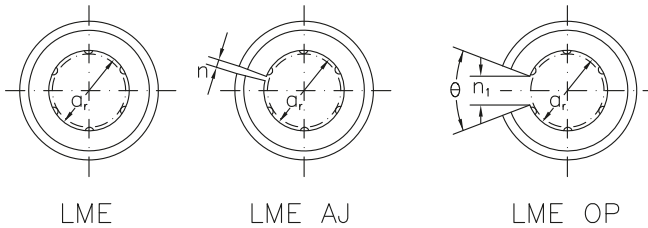

Major dimensions and tolerance

$D_{\text{Tolerance}}$	$L_{\text{Tolerance}}$	$B_{\text{Tolerance}}$	W	D1	H	h1		Eccen- tricity max	Radial clearance max	Basic load C	Rating C_0	Nominal part no.
mm								μm		kgF		
12 ⁰ _{-0,008}	22 ⁰ _{-0,02}	14,5 ⁰ _{-0,2}	1,1	11,5	1	-	-	12	-5	21	27	LME5
16 ⁰ _{-0,008}	25 ⁰ _{-0,02}	16,5 ⁰ _{-0,2}	1,1	15,2	1	-	-	12	-5	21	41	LME8
22 ⁰ _{-0,009}	32 ⁰ _{-0,02}	22,9 ⁰ _{-0,2}	1,3	21	1,5	7,5	78°	12	-7	52	79	LME12
26 ⁰ _{-0,009}	36 ⁰ _{-0,02}	24,9 ⁰ _{-0,2}	1,3	24,9	1,5	10	78°	12	-7	59	91	LME16
32 ⁰ _{-0,011}	45 ⁰ _{-0,02}	31,5 ⁰ _{-0,2}	1,6	30,3	2	10	60°	15	-9	88	140	LME20
40 ⁰ _{-0,011}	58 ⁰ _{-0,03}	44,1 ⁰ _{-0,3}	1,85	37,5	2	12,5	60°	15	-9	100	160	LME25
47 ⁰ _{-0,011}	68 ⁰ _{-0,03}	52,1 ⁰ _{-0,3}	1,85	44,5	2	12,5	50°	15	-9	160	280	LME30
62 ⁰ _{-0,013}	80 ⁰ _{-0,03}	60,6 ⁰ _{-0,3}	2,15	59	3	16,8	50°	17	-13	220	410	LME40
75 ⁰ _{-0,013}	100 ⁰ _{-0,03}	77,6 ⁰ _{-0,3}	2,65	72	3	21	50°	17	-13	390	810	LME50
90 ⁰ _{-0,015}	125 ⁰ _{-0,04}	101,7 ⁰ _{-0,4}	3,15	86,5	3	27,2	54°	20	-13	480	1020	LME60

LM < Built-in synthetics resin retainers >

This type is a metric dimension series generally used in Europe.

Linear ball bushing

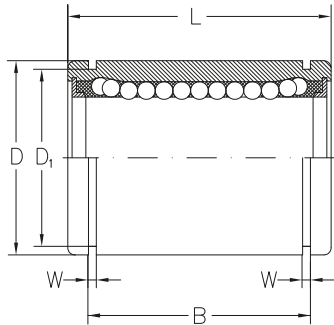

Nominal diameter	Nominal part no.		Ball circuit	Mass	Adjustable type	Open type	Nominal shaft diameter	Major dimensions and tolerance		
	Standard type	Seal type						Tolerance	D _{Tolerance}	
inch/mm	-	-	-	kg	-	-	inch/mm	-	-	
1/4 6,350	LMB4	LMB4 UU	4	0,008	LMB4 AJ	-	0,250 6,350	0 -0,0040	0,5000 12,700	0 -0,00045
										0 -0,011
3/8 9,525	LMB6	LMB6 UU	4	0,014	LMB6 AJ	-	0,3750 9,525	0 15,875	0,6250 15,875	0 -0,00050
1/2 12,700	LMB8	LMB8 UU	4	0,037	LMB8 AJ	LMB8 OP	0,5000 12,700	0 -0,0090	0,8750 22,225	0 -0,013
5/8 15,875	LMB10	LMB10 UU	4	0,076	LMB10 AJ	LMB10 OP	0,625 15,875	1,1250 28,575		
3/4 19,050	LMB12	LMB12 UU	5	0,095	LMB12 AJ	LMB12 OP	0,7500 19,050	0 -0,0040	1,2500 31,750	0 -0,00065
1 25,400	LMB16	LMB16 UU	6	0,200	LMB16 AJ	LMB16 OP	1,0000 25,400	1,5625 39,688		
1-1/4 31,750	LMB20	LMB20 UU	6	0,440	LMB20 AJ	LMB20 OP	1,2500 31,750	0 -0,0050	2,0000 50,800	0 -0,00075
1-1/2 38,000	LMB24	LMB24 UU	6	0,670	LMB24 AJ	LMB24 OP	1,5000 38,100	2,3750 60,325	0 60,325	0 -0,019
2 50,800	LMB32	LMB32 UU	6	0,114	LMB32 AJ	LMB32 OP	2,0000 50,800	0 -0,0010	3,0000 76,200	0 -0,00090
										0 -0,022

LM < Built-in synthetics resin retainers >

This type is a metric dimension series widely used in Japan and other countries

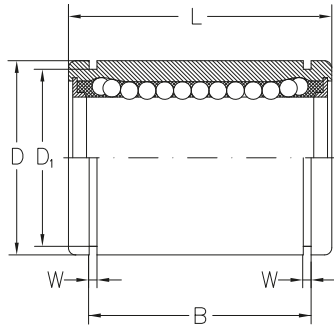

L	Tolerance B		Tolerance W		D1	h	h1	θ	Eccen- tricity	Radial clearance	Basic load rating		Nominal part no.
	max	max	C	C ₀									
inch/mm													
0,7500 19,050	0 -0,008	0,5110 12,98	0 -0,008	0,390 0,992	0,4687 11,906	0,04 1	- -	- -	0,0005 12	-0,0001 -3	206	265	LMB4
	0 -0,200	0 -0,200											
0,8750 22,225		0,6358 16,15		0,390 0,992	0,5880 14,935	0,04 1	- -	- -	0,0005 12	-0,0001 -3	225	314	LMB6
1,2500 31,750		0,9625 24,46		0,0459 1,168	0,8209 20,853	0,06 1,5	0,34 7,9375	80°	0,0005 12	-0,0001 -4	510	764	LMB8
1,5000 38,100		1,1039 28,04		0,0559 1,422	1,0590 26,899	0,06 1,5	0,375 9,525	80°	0,0005 12	-0,0001 -4	774	1180	LMB10
1,6250 41,275		1,1657 29,61		0,0559 1,422	1,1760 29,870	0,06 1,5	0,4375 11,1125	60°	0,0006 15	-0,0002 -6	862	1370	LMB12
2,2500 57,150	0 -0,012	1,7547 44,57	0 -0,012	0,0679 1,727	1,4687 37,306	0,06 1,5	0,5625 14,2875	50°	0,0006 15	-0,0002 -6	980	1570	LMB16
2,6250 66,675	0 -0,300	2,0047 50,92	0 -0,300	0,0679 1,727	1,8859 47,904	0,10 2,5	0,625 15,875	50°	0,0008 20	-0,0003 -8	1570	2740	LMB20
3,000 76,200		2,4118 61,26		0,0859 2,184	2,2389 56,870	0,12 3	0,75 19,05	50°	0,0008 20	-0,0003 -8	2180	4020	LMB24
4,000 101,600		3,1917 81,07		0,1029 2,616	2,8379 72,085	0,12 3	1,0 25,40	50°	0,0010 25	-0,0005 -13	3820	7940	LMB32
	0 -0,022												

Standard linear ball bushing Steel drawn cup/cage plastic

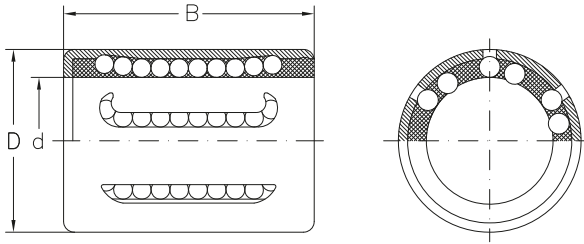

Dimensions		B	Load capacity		Designation bearing	Mass
d	D		dyn.	stat.		
mm					-	g
6	12	22	400	239	KH0622	7
8	15	24	435	280	KH0824	12
10	17	26	500	370	KH1026	14,5
12	19	28	620	510	KH1228	18,5
14	21	28	620	520	KH1428	20,5
16	24	30	800	620	KH1630	27,5
20	28	30	950	790	KH2030	32,5
25	35	40	1990	1670	KH2540	66
30	40	50	2800	2700	KH3050	95
40	52	60	4400	4450	KH4060	182
50	62	70	5500	6300	KH5070	252

Pillow blocks

Feature

The spherical outside surface ball bearings of ART are deep groove ball bearings with wide and narrow inner rings, consisting of insert bearings (SA200, SB200, UC200, UEL200, UK200, UCX00 and UC300) and various housing. The type of bearing units are defined according to the different mounting methods of the bearings to shafts: the set-screws type, the adapter type, the eccentric locking collar type.

The ART housing are mainly casting housing. There are pressed steel plate housing as well align with ease during operation and can be conveniently mounted or dismounted.

The bearing units can operate satisfactorily under working conditions, especially for machines operating in dusty or muddy surroundings. Thus, they are widely used in agricultural, construction and transmission machineries, etc.

There are various types of sealing devices for our products, such as synthetic rubber seals, slinger with synthetic rubber seals and triple lip seals etc.

Sufficient lubricating grease has been put into the bearing during manufacturing, which can act as lubricating as well as rust proof. No more grease is needed to put in during the lubricating period when the bearings operate under normal conditions. Lubricating grease can be added from the fittings when the relubricate bearings operate under hard conditions.

The outer ring of the bearing, has spherical outside surface which can be fitted to the concave spherical surface of the housing, and the fit between them can be clearance fit or interference fit according to different conditions. This combination provides self-alignment between the self-contained bearing and the housing, and compensates for a certain alignment errors or flexing of the shaft when the bearing is in operation. This definitely increases the bearing service life.

Lubrication

The Spherical Outside Surface Ball Bearings of ART generally use CG-2 rust proof lithium based lubricating grease, with physical chemical properties shown in the following table 1. Grease is filled in the spherical outside surface ball bearings during manufacturing.

Static safety factors		
		Table 1
Density 1/mm	Without operation	268
	Operated 60 times	260
Dropping point °C		128
Mechanical impurities pc/gr	10-25 µm	within 1000
	25-75 µm	within 500
	above 75 µm	0
Base oil kinematical viscosity 40° cst		80,3

The bearings usually operate below the temperature of 120°C (the measuring temperature of the outer rings is 100°C). Grease life reduction has to be taken into account when the bearing continues to operate at a temperature should not be lower than -30°C.

The permissible speed of rotation is connected with the fit between shaft and bearing. It is reconnected with the fit between shaft and bearing. It is recommended that, under normal operating conditions, the fit between the bearing and the shaft is h7. Looser fit allowing lower speed is recommended when heavier load is applied.

Tolerance for bearing units

Tolerances on inner rings of bearing with cylindrical bore									
Unit: 0.001 mm									
Nominal bore diameter		Cylindrical bore				Radial run-out			
d		bore diameter dm		d		width Bi			
over	incl.	high	low	high	low	high	low	max.	
mm									
10	18	+18	0	+22	-4	0	-120	12	
18	30	+21	0	+25	-4	0	-120	15	
30	50	+25	0	+30	-5	0	-120	18	
50	80	+30	0	+36	-6	0	-150	22	
80	120	+35	0	+42	-7	0	-200	28	
120	150	+40	0	+48	-8	0	-250	35	

Table 2

Note: dm is defined as the arithmetical mean of the largest and smallest diameter obtained by two-point measurements.

Tolerances on inner rings of bearings with tapered bore					
Unit: 0.001 mm					
Nominal bore diameter		Δd		Δd1-Δd	
d	incl.	high	low	max.	min.
mm					
18	30	+33	0	+21	0
30	50	+39	0	+25	0
50	80	+46	0	+30	0
80	120	+54	0	+35	0
120	150	+63	0	+40	0

Table 3

Note: The deviation from nominal taper are defined by the limits of (Δd1-Δd), where Δd1 is actual deviations of d1 from nominal diameter at the largest end of bore and Δd is actual deviation of d from bearing bore nominal diameter.

d1 is obtained by the following formula:
 $d1 = d + 0.083333 B$, where B is width of the bearing inner ring.

The nominal taper angle = 2° 23'9.4".

Please refer to the figures 1.

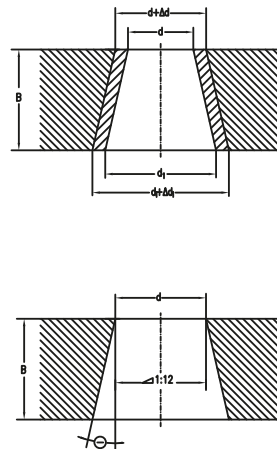

Fig. 1

Tolerances on outer ring Unit: 0.001 mm				
Nominal bore diameter	D _m	Radial run-out		
		high	low	max.
D over	incl.	deviations		
mm				
40	50	0	-11	20
50	80	0	-13	25
80	120	0	-15	35
120	150	0	-18	40
150	160	0	-25	45

Table 4

Note: D_m is defined as the arithmetical means of the largest and the smallest diameter obtained by two-point measurement.

The low deviation of outside diameter D_m does not apply within the distance of 1/4 the width of outer ring from the sides.

Tolerance for distance "h" between the radial plane passing through center of outer ring and a side of inner ring Unit: 0.001 mm		
Nominal bore diameter	n	
	d over	incl. deviations
mm		
40	50	± 200
50	80	± 250
80	120	± 300
120	160	± 350

Table 5

Please refer to the figures 2.

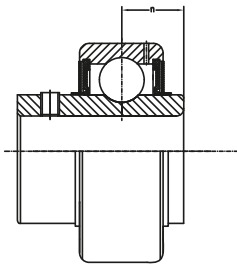

Fig. 2

Chamfer dimensions		
Nominal dimensions	r	
	max.	min.
mm		
1	1.5	0.6
1.5	2	1
2	2.5	1.5
2.5	3	2
3	3.5	2.5
3.5	4	3
4	4.5	3.5
5	6	4

Table 6

Please refer to the figures 3.

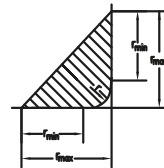

Fig. 3

Center height tolerances for pillow block type housing

Please refer to below figures 4 and table 7

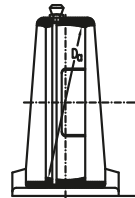

Fig. 4

Tolerances for flanged type housing (F, FS, FL, FT, FA, FB, FC)

Please refer below figures 5a, 5b and table 8a, 8b.

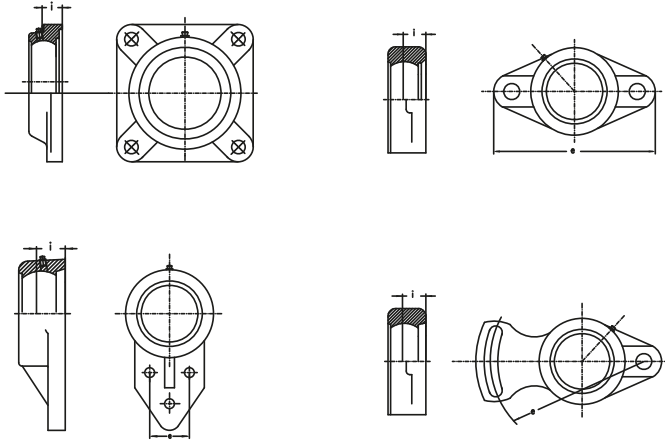

Fig. 5a

Tolerances for flanged type housings (F, FS, FL, FT, FA, FB) Center height tolerances for pillow block type housings Unit: 0.001 mm						Table 7
Housing number						h deviations
mm						
P203			AK204	PA203		
P204			AK205	PA204	PH204	
P205		P305	AK206	PA205	PH205	
P206	PX05	P306	AK207	PA206	PH206	±150
P207	PX06	P307	AK208	PA207	PH207	
P208	PX07	P308	AK209	PA208	PH208	
P209	PX08	P309	AK210	PA209	PH209	
P210	PX09	P310	AK211	PA210	PH210	
P211	PX10	P311	AK212	PA211	PH211	
P212	PX11	P312	AK213	PA212	PH212	
P213	PX12	P313	AK214	PA213	PH213	
P214	PX13	P314	AK215		PH214	
P215	PX14	P315			PH215	±200
P216	PX15	P316			PH216	
P217	PX16					
P218						

Unit: 0.001 mm								Table 8a	
Housing number								e	i
mm								deviations	deviations
F204		FL204		FT204	FS204	FA204	FB204		
F205	F305	FL205	FL305	FT205	FS205	FA205	FB205		
F206	F306	FL206	FL306	FT206	FS206	FA206	FB206		
F207	F307	FL207	FL307	FT207	FS207	FA207	FB207	±700	±500
F208	F308	FL208	FL308	FT208	FS208	FA208	FB208		
F209	F309	FL209	FL309	FT209	FS209	FA209	FB209		
F210	F310	FL210	FL310	FT210	FS210	FA210	FB210		
F211	F311	FL211	FL311	FT211	FS211	FA211	FB211		
F212	F312	FL212	FL312	FT212	FS212	FA212	FB212		
F213	F313	FL213	FL313	FT213	FS213	FA213	FB213		
F214	F314	FL214	FL314	FT214	FS214				
F215	F315	FL215	FL315		FS215			±1000	±800
F216		FL216							
F217		FL217							
F218		FL218							

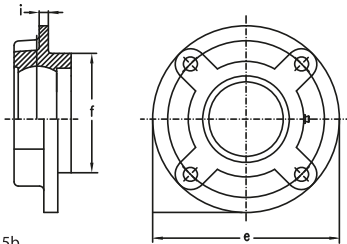

Fig. 5b

Tolerance for take-up type housing (T,ST)

Please refer to below figure 6 and table 9a, 9b.

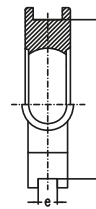

Fig. 6

Tolerance for flanged type housing (FC)					Table 8b
Unit: 0.001 mm					
Housing number	f	e	i	Radial run-out of machined pilot max	
	high	low	deviations	deviations	deviations
FC 204					
FC 205	0	-46			
FC 206					
FC 207			± 700	± 500	200
FC 208					
FC 209	0	-54			
FC 210					
FC 211					
FC 212					
FC 213					
FC 214					
FC 215	0	-63	± 1000	± 800	300
FC 216					
FC 217					
FC 218	0	-72			

Tolerances for take-up type housing (T)				Table 9a
Unit: 0.001 mm				
Housing number	k	e	Parallelism of guide	
	high	low	max	
mm				
T204	+200	0	500	
T210	0	-500		
T211	+300	0	600	
T217	0	-800		

Tolerances for take-up type housing (ST) Unit: 0.001 mm

Housing number	k deviations		e deviations	Parallelism of guide max
	high	low		
Table 9b				
mm				
ST204	+500		± 250	500
ST210	-250			
ST211	+1000		± 250	600
ST215	-250			

Note:

$D_{am} = (D_{a \max} + D_{a \min}) / 2$

$D_{a \max}$ - maximum measured value of D_a

$D_{a \min}$ - minimum measured value of D_a

Dimensional tolerances for spherical inside diameter of housing are classified as H7 for clearance fit and J7 for interference fit.

As the self - contained for bearings are equipped with locking-pin, clearance fit H7 is normally applied.

Tolerances on spherical inside diameter Unit: 0.001 mm

Nominal spherical inside diameter	Symbol H7		Symbol J7		Symbol H7		Symbol J7		Symbol H7		Symbol J7	
	D_a	D_{am}	D_a	D_{am}	D_a	D_{am}	D_a	D_{am}	D_a	D_{am}	D_a	D_{am}
over	incl.	high	low	high	low	high	low	high	low	high	low	low
Table 10												
mm												
30	50	+25	0	+30	-5	+14	-11	+19	-16			
50	80	+30	0	+36	-6	+18	-12	+24	-18			
80	120	+35	0	+42	-7	+22	-13	+29	-20			
120	180	+40	0	+48	-8	+26	-14	+34	-22			
180	250	+46	0	+55	-9	+30	-16	+39	-25			

Machining tolerances

Nominal dimension		Dimensional tolerance
over	incl.	
Table 11		
mm		
4	16	± 0,2
16	63	± 0,3
63	250	± 0,5

Casting tolerances on thickness

Nominal dimension		Dimensional tolerance
over	incl.	
Table 13		
mm		
up	5	± 1
5	10	± 1,5
10	20	± 2
20	30	± 3
30	50	± 3,5

Casting tolerances on length

Nominal dimension		Dimensional tolerance
over	incl.	
Table 12		
mm		
up	100	± 1,5
100	200	± 2,0
200	400	± 3,0
400	800	± 4,0

One side machining tolerances

Nominal dimension		Dimensional tolerance
over	incl.	
Table 14		
mm		
up	5	± 1
5	100	± 1,5
100	200	± 2
200	400	± 3

Note:

Dimensional tolerances and deviations are for ordinary grade;

Dimensional tolerances on length and thickness may be added with deviations on draft taper.

Radial internal clearance of bearings

The radial internal clearance of the bearing for the unit is the same as the value of ISO 5753, the internal radial clearance for the spherical outside

surface ball bearing is usually greater than that for the same size of deep groove ball bearing. The clearance for the cylindrical bore bearing is shown in table 15, while the clearance for the tapered bore bearing is shown in table 16.

Radial internal clearance of cylindrical bore bearings (with set-screws and eccentric locking collar) Unit: 0,001 mm							
Nominal bore diameter		Clearance symbol					
d	incl.	C2		normal		c3	
over		min.	max.	min.	max.	min.	max.
mm							
10	18	3	18	10	25	18	33
18	24	5	20	12	28	20	36
24	30	5	20	12	28	23	41
30	40	6	20	13	33	28	46
40	50	6	23	14	36	30	51
50	65	8	28	18	43	38	61
65	80	10	30	20	51	46	71
80	100	12	36	24	58	53	84
100	120	15	41	28	66	61	97
120	140	18	48	33	88	71	114

Table 15

Radial internal clearance of tapered bore bearings (with adapter sleeve) Unit: 0,001 mm							
Nominal bore diameter		Clearance symbol					
d	incl.	C2		normal		c3	
over		min.	max.	min.	max.	min.	max.
mm							
10	18	10	25	18	33	25	45
18	24	12	28	20	36	28	48
24	30	12	28	23	43	30	61
30	40	13	33	28	46	40	64
40	50	14	36	30	51	45	73
50	65	18	43	38	61	55	90
65	80	20	51	46	71	65	105
80	100	24	58	53	84	75	120
100	120	28	66	61	97	90	140
120	140	33	81	71	114	150	160

Table 16

Bearing Size selection

The bearing size is usually selected according to the required life and reliability under a specific type of load charged on the spherical outside surface ball bearing

The load applied to the bearing operating under static or slow oscillating and rotating ($n < 10r/min$) condition is defined as dynamic load.

The load capacity of the bearing is expressed by the basic dynamic load rating which is shown in the spherical outside surface ball bearing's table.

Under normal mounting, lubricating and maintaining conditions, the operating bearing will have fatigue flaking due to the repeating action of variable load charged on the contact area between the rings and rolling elements. Generally, the fatigue flaking is the cause of normal damage of rolling bearings. Therefore, the usual bearing life refers to the bearing fatigue life. The life of group of apparently identical bearings operating under a considerable dispersion. For this reason, the bearing life is closely connected with the damaging probability or the reliability requirement.

The radial rating load of ball bearing with 90% reliability and 500 hours minimum life is shown in figure 7.

Life: The life of a rolling bearing is defined as the total number of revolution which the bearing is capable of enduring before the first evidence of fatigue flaking develops on any one rings or rolling elements.

Reliability: The reliability is the percentage of the bearings of a group of apparently identical bearings operating under identical conditions which can expect to attain or exceed a certain defined life. The reliability of individual bearings is the probability of the bearing to attain or exceed a defined life.

Basic rating life: For a group of apparently identical rolling bearings operating under identical conditions, the basic rating life is defined as the total number of revolutions that 90% of the bearings can be expected to complete or exceed.

Basic rating life

The fatigue rating life of spherical outside surface ball bearings is calculated by the following formula:

$$L_{10} = \left(\frac{C}{P}\right)^3, \text{ or } \frac{C}{P} = L_{10}^{1/3}$$

where:

L_{10} - basic rating life, $10^6 r$

P - basic dynamic load rating, N

N - equivalent dynamic bearing load, N

The basic dynamic load rating C is a hypothetical constant load with a fixed direction under which the bearing can attain a basic life of one million revolutions theoretically. For radial bearings, the load refers to the radial load.

The equivalent dynamic bearing load P is a constant load with a fixed direction under which the bearing life is identical to that of the bearing operating under actual load.

For a bearing operating with a constant rotation speed, the basic rating life can be expressed in terms of operating hours:

$$L_{10h} = \frac{10^6}{60 n} \left(\frac{C}{P}\right)^3, \text{ or } L_{10h} = \frac{10^6}{60 n} L_{10} = \frac{16666}{n} \left(\frac{C}{P}\right)^3$$

where:

L_{10h} - basic rating life, h

n - bearing operating speed of rotation, r/min

For easier calculation, 500 hours as base of rating life is taken, and the speed factor f_n and the life factor f_h is introduced.

$$f_n = \left(\frac{331/3}{n}\right), \quad f_h = \left(\frac{L_{10h}}{500}\right)$$

In this, the formula is simplified to:

$$C = \frac{f_h}{f_n} P$$

The values of f_n and f_h can be found in figure 7 by referring to the operation speed n and the anticipated bearing service life L_{10h} . Then, with the radial load (or the equivalent dynamic bearing load), the basic dynamic load rating can be determined according to the spherical outside surface ball bearing's table. If the bearing operate under indeterminate loads and rotation speed, the following formula should be applied when calculating the bearing life:

$$P_m = \sqrt[3]{\frac{1}{N} \int_0^N P^3 dr}$$

where:

P_m - mean equivalent dynamic bearing load, N

P - equivalent dynamic bearing load, N

N - total revolution numbers with one load changing cycle, r

n rpm	f_n	L_{10h} h	f_h
60000	0.082	80000	5.4
40000	0.09	60000	5
30000	0.10	40000	4.5
20000	0.12	30000	4
15000	0.14	20000	3.5
10000	0.18	15000	3
8000	0.18	10000	3.0
4000	0.20	2000	2.5
3000	0.22	1000	2.5
2000	0.24	800	2.5
1500	0.26	600	2.5
1000	0.28	400	2.5
800	0.30	300	2.5
600	0.35	200	2
400	0.4	1500	1.9
300	0.4	1000	1.9
200	0.5	800	1.7
150	0.6	600	1.5
100	0.7	400	1.4
80	0.8	300	1.3
60	0.8	200	1.2
40	1.0	100	1.1
30	1.0	600	1.0
20	1.1	400	0.95
15	1.2	300	0.90
10	1.3	200	0.80
8	1.4	100	0.75
6	1.4	200	0.74

Anticipated bearing service life

When selecting a bearing, one should usually predetermine an appropriate service life according to the relevant machine type, operating condition and reliability requirement. Generally the anticipated bearing service life can be determined by referring to the maintenance period of a machine.

Calculating method of equivalent dynamic bearing load P .

The basic equivalent dynamic bearing load is determined under a hypothetical condition. When calculating the bearing life, the actual load has to be converted to dynamic bearing load which is in conformity with the load condition determining the dynamic load rating. General equation for calculating the equivalent dynamic bearing load:

$$P = XF_r + YF_a$$

where:

- P - equivalent dynamic bearing load, N
- F_r - actual radial load, N
- F_a - actual axial load, N
- X - radial factor
- Y - thrust factor

The values of X and Y are determined by the ratio between the applied axial load F_a and the basic static load rating C_0 . The axial load which the spherical outside surface ball bearing can carry is determined by the mounting method of the bearing on the shaft.

For bearing of set-screw Locking type or eccentric Locking collar type, if flexible shafts are applied and the set-screws are tightened enough, the axial load F_a which the bearings can carry not surpass 20% of the radial load F_r .

For bearing of adapter sleeve Locking type, if the nut is properly tightened, the axial load F_a can be maximally 15% to 20% of the radial load.

The value of radial and thrust factors X and Y for spherical outside surface ball bearings can be obtained from the following Table 17.

When twist load is applied to the bearing, the equivalent dynamic bearing load is calculated by the following equation:

$$P_m = f_m P$$

where:

- P_m - equivalent dynamic bearing load when considering twist load
- f_m - twist load factor, which is defined as follows:
 - when the twist load is small: $f_m = 1,5$
 - when the twist load is big: $f_m = 2$

Example of bearing size selection

When shocking load is applied to the bearing, the equivalent dynamic bearing load can be calculated by the following equation:

$$P_d = f_d P$$

where:

- P_d - equivalent dynamic bearing load when considering shocking load
- f_d - shocking load factor, which is defined as follows:
 - when no shocking load or mirror shocking load is applied: $f_d = 1-1,2$
 - when adequate shocking load is applied: $f_d = 1,2 - 1,8$

How to select the size of bearing: one spherical outside surface ball bearings is to operate at a rotation speed of 1000r/min under only a radial load of $F_r = 3000$ N, with a basic rating life of a least 20,000 hours.

Select the bearing size

From the required rotation speed it can be found that: $f_n = 0,322$ (figure 7 shows about 0,32, refer to page 631).

From the required basic rating life (anticipated service life), it can be found that:

$f_h = 3,42$ (figure 7 shows about 3,4, refer to page 631).

Under only radial load, i.e.

$$P = Fr = 3000 \text{ N}$$

Therefore,

$$C = \frac{f_h}{f_n} P = \frac{3,42}{0,322} = 31,863 \text{ N}$$

A simplified way to calculate the bearing life can be applied by using figure 8.

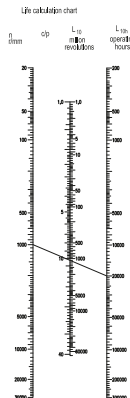

Radial and thrust factors X and Y for spherical outside surface ball bearings

Table 17

Clearance for normal						Clearance for C3					
$\frac{F_a}{C_a}$	$\frac{F_a}{F_r} \leq e$		$\frac{F_a}{F_r} > e$		e	$\frac{F_a}{F_r} \leq e$		$\frac{F_a}{F_r} > e$		e	
	X	Y	X	Y		X	Y	X	Y		
0,025	1	0	0,56	2	0,22	1	0	0,46	1,74	0,3	
0,04	1	0	0,56	1,8	0,24	1	0	0,46	1,61	0,33	
0,07	1	0	0,56	1,6	0,27	1	0	0,46	1,46	0,36	
0,13	1	0	0,56	1,4	0,31	1	0	0,46	1,3	0,41	
0,25	1	0	0,56	1,2	0,37	1	0	0,46	1,14	0,47	
0,5	1	0	0,56	1	0,44	1	0	0,46	1	0,54	

By connecting n and the required basic rating life L_{10h} with a straight line, it can be found that C/P value is 10,6.

As is known, $P = F_r = 3000$ N, thus the required basic dynamic load rating is:

$$C = 3000 \times 10,6 = 31,800, \text{ N}$$

In this way, we can select the spherical outside surface ball bearings inside this catalogue (refer to pages 699-705).

Adjusted rating life equation

The basic rating life L_{10} calculated with bearing life calculation formula can be applied to calculate the rating life of bearings made of ordinary bearing steel (i.e. bearing life with reliability of 90%)

Due to more and more of machinery products demanding higher reliability and better quality steel (ISO 281/1-1977), an adjusted rating life calculation equation is suggested. i.e.

$$L_n = a_1 a_2 a_3 L_{10}$$

For spherical outside surface ball bearing:

$$L_n = a_1 a_2 a_3 (C/P)^3$$

where:

L_n - under specified material and lubricating conditions, bearing life with (100-n)% no breaking probability (i.e. reliability).

a_1 - life adjustment factor for reliability (table 18)

a_2 - life adjustment factor materials (table 19)

a_3 - life adjustment factor for operating conditions (table 20)

Life adjustment factor for reliability a_1

Table 18

Reability	90	95	96	97	98	99
%						
L_n	L_{10}	L_5	L_4	L_3	L_2	L_1
a_1	1	0,62	0,53	0,44	0,33	0,21

Life adjustment factor for materials a_2

Table 19

Normal chromium bearing steel		$a_2 = 1$
Special smelted bearing steel	Vacuum degassed bearing steel	$a_2 = 3$
	Vacuum resmelted bearing steel	$a_2 = 5$
When material hardness lowered by high frequency	tempering	$a_2 < 1$

Life adjustment factor for operating conditions a_3

Table 20

When under normal operating conditions:	$a_3 = 1$
- properly mounted	
- sufficiently lubricated	
- without outside matters intrusion	
When under operating temperature, the spherical outside surface ball bearings lubricating grease viscosity lower than $13 \text{ mm}^2/\text{s}$	$a_3 < 1$

Selection of shaft

The shaft on which bearing units are mounted shall be free from band and flexure.

For the units with cylindrical bore (with set-screws or eccentric locking collar) clearance fit is usually adopted for mounting the units on the shaft, and shaft tolerances in table 21 are recommended for such loose fit, but for high speed or highly accurate operation or such

application which is accompanied by heavy shock loads, interference fit is to be adopted. Table 22 shows recommended shaft with interference fit, the eccentric locking collar may omitted.

Tapered bore bearings permit wider tolerances of the shaft since they are locked to the shaft by means of adapted sleeves.

Recommended shaft tolerances for tapered bore bearings listed in table 23.

Shaft diameter		Deviation of tolerances in shaft							
		For lower speed		For medium speed		For rather high speed		For high speed	
over	incl.	h9		h8		h7		J6	
mm		max.	min.	max.	min.	max.	min.	max.	min.
10	18	0	-43	0	-27	0	-18	+8	-3
18	30	0	-52	0	-33	0	-21	+9	-4
30	50	0	-62	0	-39	0	-25	+11	-5
50	80	0	-74	0	-46	0	-30	+12	-7
80	120	0	-87	0	-54	0	-35	+13	-9
120	180	0	-100	0	-63	0	-40	+14	-11

Shaft diameter		Deviation of tolerances in shaft							
		Higher speed		Rather heavy load		Highest load		Heavy load	
over	incl.	m6		m7		m6		m7	
mm		max.	min.	max.	min.	max.	min.	max.	min.
10	18	+18	+7	+25	+7	+23	+12	+30	+12
18	30	+21	+8	+29	+8	+28	+15	+36	+15
30	50	+25	+9	+34	+9	+33	+17	+42	+17
50	80	+30	+11	+41	+11	+39	+20	+50	+20
80	120	+35	+13	+48	+13	+45	+23	+58	+23
120	180	+40	+15	+55	+15	+52	+27	+67	+27

Shaft diameter		Deviation of tolerances For shot shaft			
		h9		h10	
over	incl.	max.	min.	max.	min.
10	18	0	-43	0	-70
18	30	0	-52	0	-84
30	50	0	-62	0	-100
50	80	0	-74	0	-120
80	120	0	-87	0	-140
120	180	0	-100	0	-160

Mounting of bearing units on shaft

The bearing units can be easily installed in principle at any place. However, in order to have a long service life, it is desirable that the mounting base is flat and rigid.

In case of either the vibration is caused to the bearing, the alternating movement takes place, the load applied to the bearing is large, or the

shaft rotation speed is rapid, it is desired to provide with the filed seat or concave section at the part where the set-screws contact with the shaft. If large thrust load is charged, it is recommended that joggling tightened with nuts be used to install the bearing most effectively to the shaft: as shown in figure 9.

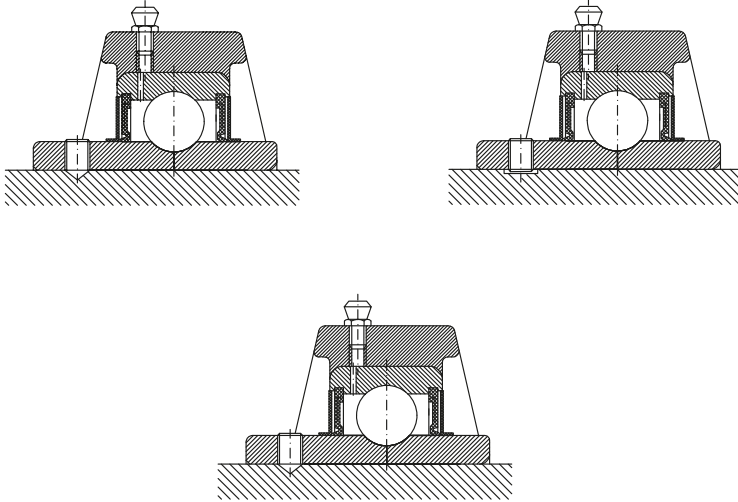

Fig. 9

Bearings units with adapter sleeve

Bearing unit with adapter sleeve permits wider shaft tolerance and can be used in applications where vibrations and shocks are heavily.

Mounting processes of these units as follows:

First, the sleeve is installed to an arbitrary position. After the shark proof washer is inserted, the nut is tightened.

The proper nut tightening condition can be obtained if it is tightened enough by hand and then rotated by $2/5$ to $3/5$ revolution with a spanner.

After tightening the nut, bend the shark proof washer within the slot. Otherwise, the nut may be loosened and creep may be caused between the shaft and sleeve. It is necessary the nut can not be tightened too much.

Bearings units with eccentric locking collar

The eccentric part of the collar mates with the inner ring of the bearing which is made eccentric with the collar. When locked to the shaft by hand in direction of the shaft rotation, the eccentric locking collar tightens automatically to the shaft by force of working radial load. Then, lock the set-screws provided on the collar to fix the eccentric collar to the shaft. At the shaft rotation force or load is not charged on the set-screws directly, it will not loosen during operation.

Bearing units with set-screws





There are two set-screws located at two places on one side of the wide inner ring 120 apart with which the bearing units can be mounted to the shaft. When mounting the bearing to the shaft, the torque shown in the following table 23 is recommended to tighten the set screws to shaft.

The material for cast iron housing

The material of cast iron housing under ISO/DIS GG20, the mechanical properties please refer to table 24.

Proper tightening torque of set-screws				
Set-screws type	Bearing type	Tightening torque	Table 24	
			N.m	lbf.in
mm	inch			
M 5x0,8	No. 10-32 UNF	SB 201 - SB 203, UC 201 - UC 203	3 - 3,5	28
M 6x1	1/4-28 UNF	SB 204 - SB 207, UC 204 - UC 206 SA 201 - SA 206, UEL 201 - UEL 205 UC X05, UC 305 - UC 306	3,5 - 4	30 - 35,4
M 8x1	5/16-24 UNF	SB 208, UC 207 - UC 209 SA 207 - SA 210, UEL 206 - UEL 210 UC X06 - UC X08, UC 307	8,0 - 8,5	69 - 73,5
M 10X1,25	3/8-24 UNF	UC 210 - UC 212 SA 211, UEL 211 - UEL 215 UC X09 - UC X11, UC308 - 309	16,5 - 17,5	144 - 152
M 12X1,25	7/16-20 UNF	UC 213 - UC 218 UC X12 - UC X16 UC 310 - UC 314	26,5 - 27,5	235 - 243
M 14X1,5	1/2-20 UNF	UC 315 - UC 316	33,5 - 34,5	296 - 304

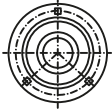
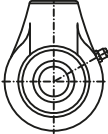
The mechanical properties of cast iron housing			
Number	Major wall thickness of casting piece	Strain stress	Hardness
			m6
	mm	N/mm ²	HB
ISO/DIS GG20	2,5-10	220	
U.S.A. Grade 35	>10-20	195	170 - 220
JIS FC20	>20-30	170	
	30-50	160	

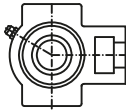
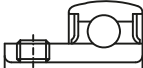
Pillow block type	
Flanged units type	
Two bolts flanged units type	
Flanged cartridge units type	
Hanger units type	
Cylindrical cartridge units type	
Take up units type	
Insert bearings	

Standard duty pillow blocks pressed steel housing set screws type

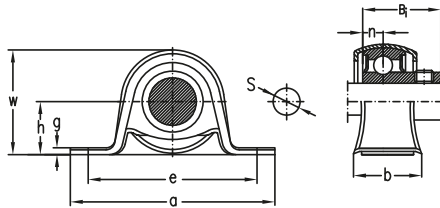

Shaft dia.	Nominal dimensions										Bolt size	Unit number	Bearing number	Housing number
	h	a	e	b	s	g	w	Bi	n					
mm												-		
12	22,2	86	68	25	9,5	3,2	43,8	22	6	M8	SBPP201	SB201	PP203	
15	22,2	86	68	25	9,5	3,2	43,8	22	6	M8	SBPP202	SB202	PP203	
17	22,2	86	68	25	9,5	3,2	43,8	22	6	M8	SBPP203	SB203	PP203	
20	25,4	98	76	32	9,5	3,2	50,5	25	7	M8	SBPP204	SB204	PP204	
25	28,6	108	86	32	11,5	4	56,6	27	7,5	M10	SBPP205	SB205	PP205	
30	33,3	117	95	38	11,5	4	66,3	29	8	M10	SBPP206	SB206	PP206	
35	39,7	129	106	42	11,5	4,6	78	32	8,5	M10	SBPP207	SB207	PP207	

Note: Inch sizes available on request.

Standard duty pillow blocks cast housing set screws type

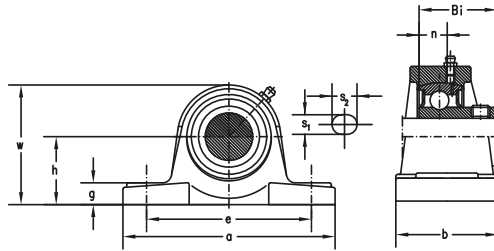

Shaft dia.	Nominal dimensions		e	b	s ₁	s ₂	g	w	Bi	n	Bolt size	Unit number	Bearing Housing number number	
	h	a											number	number
mm														
20	31,8	128	98	38	11	14	14	63	25	7	M10	SBAK204	SB204	AK204
25	33,3	140	105	40	11	14	15	66,5	27	7,5	M10	SBAK205	SB205	AK205
30	39,7	160	121	44	14	19	17	79	29	8	M12	SBAK206	SB206	AK206
35	46	167	127	48	14	19	18	91	32	8,5	M12	SBAK207	SB207	AK207
40	49,2	181	140	52	14	19	19	98	34	9,5	M12	SBAK208	SB208	AK208

Note: Inch sizes available on request.

Standard duty pillow blocks cast housing set screws type

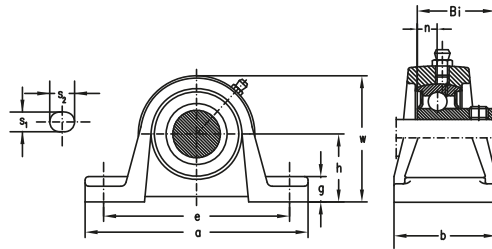

Shaft dia.	Nominal dimensions		e	b	s ₁	s ₂	g	w	Bi	n	Bolt size	Unit number	Bearing Housing number number	
	h	a											number	number
mm													-	
20	33,3	127	96	35	13	16	14	65	25	7,0	M10	SBP204	SB204	P204
25	36,5	140	105	36	13	19	15	71	27	7,5	M10	SBP205	SB205	P205
30	42,9	160	121	42	14	19	16	84	29	8	M12	SBP206	SB206	P206
35	47,6	167	127	45	15	19	17	94	32	8,5	M12	SBP207	SB207	P207
40	49,2	180	137	49	15	21	18	100	34	9,5	M12	SBP208	SB208	P208

Note: Inch sizes available on request.

Standard duty pillow blocks cast housing set screws type

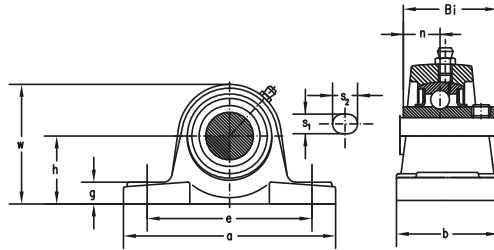

Shaft dia.	Nominal dimensions		e	b	s ₁	s ₂	g	w	Bi	n	Bolt size	Unit number	Bearing Housing number number	
	h	a											number	number
mm														
20	31,8	128	98	38	11	14	14	63	31	12,7	M10	UCAK204	UC204	AK204
25	33,3	140	105	40	11	14	15	66,5	34	14,3	M10	UCAK205	UC205	AK205
30	39,7	160	121	44	14	19	17	79	38,1	15,9	M12	UCAK206	UC206	AK206
35	46,0	167	127	48	14	19	18	91	42,9	17,5	M12	UCAK207	UC207	AK207
40	49,2	181	140	52	14	19	19	98	49,2	19	M12	UCAK208	UC208	AK208
45	52,4	189	146	54	14	19	20	105	49,2	19	M12	UCAK209	UC209	AK209
50	55,6	203	159	57	17,5	21	21	111,5	51,6	19	M16	UCAK210	UC210	AK210
55	61,9	232	181	60	18	24	23	123	55,6	22,2	M16	UCAK211	UC211	AK211
60	68,3	241	191	64	18	24	25	136	65,1	25,4	M16	UCAK212	UC212	AK212
65	74,6	262	203	70	21	28	27	147,5	65,1	25,4	M20	UCAK213	UC213	AK213
70	77,8	266	210	74	21	28	28	153,5	74,6	30,2	M20	UCAK214	UC214	AK214
75	82,6	304	241	78	22	32	30	162	77,8	33,3	M20	UCAK215	UC215	AK215

Note: Inch sizes available on request.

Standard duty pillow blocks cast housing set screws type

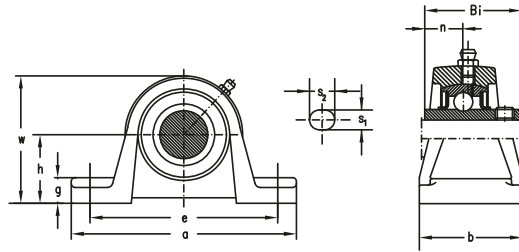

Shaft dia.	Nominal dimensions			b	s ₁	s ₂	g	w	Bi	n	Bolt size	Unit number	Bearing Housing number number	
	h	a	e										number	number
mm													-	
12	30,2	127	96	38	13	16	11	60,7	31	12,7	M10	UCP201	UC201	P203
15	30,2	127	96	38	13	16	11	60,7	31	12,7	M10	UCP202	UC202	P203
17	30,2	127	96	38	13	16	11	60,7	31	12,7	M10	UCP203	UC203	P203
20	33,3	127	96	35	13	16	14	65,0	31	12,7	M10	UCP204	UC204	P204
25	36,5	140	105	36	13	19	15	71,0	34	14,3	M10	UCP205	UC205	P205
30	42,9	160	121	42	14	19	16	84,0	38,1	15,9	M12	UCP206	UC206	P206
35	47,6	167	127	45	15	19	17	94,0	42,9	17,5	M12	UCP207	UC207	P207
40	49,2	180	137	49	15	21	18	100,0	49,2	19	M12	UCP208	UC208	P208
45	54	189	146	50	15	21	20	107,5	49,2	19	M12	UCP209	UC209	P209
50	57,2	204	159	56	19	22	21	114,0	51,6	19	M16	UCP210	UC210	P210
55	63,5	217	172	58	19	22	22	126	55,6	22,2	M16	UCP211	UC211	P211
60	69,9	238	186	64	19	25	24	139	65,1	25,4	M16	UCP212	UC212	P212
65	76,2	262	203	70	23	29	26	149	65,1	25,4	M20	UCP213	UC213	P213
70	79,4	266	210	72	23	29	27	155	74,6	30,2	M20	UCP214	UC214	P214
75	82,6	274	217	74	25	29	28	161,6	77,8	33,3	M20	UCP215	UC215	P215
80	88,9	292	232	78	25	30	30	174	82,6	33,3	M20	UCP216	UC216	P216
85	95,2	310	247	83	25	30	32	186	85,7	34,1	M20	UCP217	UC217	P217
90	101,6	326	262	88	27	30	33	198	96	39,7	M22	UCP218	UC218	P218

Note: Inch sizes available on request.

Standard duty pillow blocks cast housing set screws type

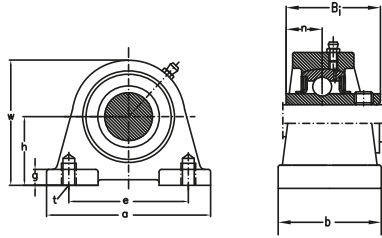

Shaft dia.	Nominal dimensions			b	g	w	f	t	Bi	n	Bolt size	Unit number	Bearing number	Housing number
	h	a	e											
mm														
12	30,2	76	52	40	11	62	13	M10	31	12,7	M10	UCPA201	UC201	PA204
15	30,2	76	52	40	11	62	13	M10	31	12,7	M10	UCPA202	UC202	PA204
17	30,2	76	52	40	11	62	13	M10	31	12,7	M10	UCPA203	UC203	PA204
20	30,2	76	52	40	11	62	13	M10	31	12,7	M10	UCPA204	UC204	PA204
25	36,5	84	56	38	12	72	15	M10	34	14,3	M10	UCPA205	UC205	PA205
30	42,9	94	66	48	13	84	18	M14	38,1	15,9	M14	UCPA206	UC206	PA206
35	47,6	110	80	48	13	95	20	M14	42,9	17,5	M14	UCPA207	UC207	PA207
40	49,2	116	84	54	13	100	20	M14	49,2	19	M14	UCPA208	UC208	PA208
45	54,2	120	90	60	13	108	25	M14	49,2	19	M14	UCPA209	UC209	PA209
50	57,2	130	94	60	14	116	25	M16	51,6	19	M16	UCPA210	UC210	PA210
55	63,5	140	104	66	14	125	25	M16	55,6	22,2	M16	UCPA211	UC211	PA211
60	69,9	150	114	68	15	138	25	M16	65,1	25,4	M16	UCPA212	UC212	PA212
65	76,2	160	124	70	15	150	25	M16	65,1	25,4	M16	UCPA213	UC213	PA213

Note: Inch sizes available on request.

Standard duty pillow blocks cast housing set screws type

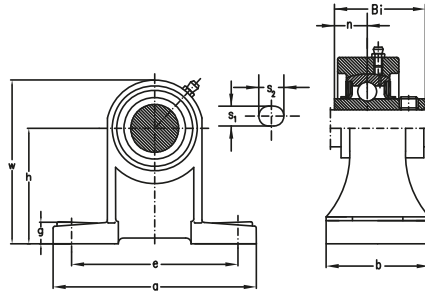

Shaft dia.	Nominal dimensions		b	s ₁	s ₂	g	w	Bi	n	Bolt size	Unit number	Bearing Housing number number		
	h	a										e	number	number
mm													-	
12	70	127	95	40	12	16	13	101	30	12,7	M10	UCPH201	UC201	PH204
15	70	127	95	40	12	16	13	101	30	12,7	M10	UCPH202	UC202	PH204
17	70	127	95	40	12	16	13	101	31	12,7	M10	UCPH203	UC203	PH204
20	70	127	95	40	12	16	13	101	31	12,7	M10	UCPH204	UC204	PH204
25	80	140	105	50	13	19	16	114	34	14,3	M10	UCPH205	UC205	PH205
30	90	165	121	50	17	21	18	130	38,1	15,9	M14	UCPH206	UC206	PH206
35	95	167	127	60	17	21	19	140	42,9	17,5	M14	UCPH207	UC207	PH207
40	100	184	137	66	17	21	20	150	49,2	19,0	M14	UCPH208	UC208	PH208
45	105	190	146	70	17	21	20	158	49,2	19,0	M14	UCPH209	UC209	PH209
50	110	204	159	70	19	22	22	165	51,6	19,0	M16	UCPH210	UC210	PH210
55	120	217	171	75	19	22	23	181	55,6	22,2	M16	UCPH211	UC211	PH211
60	130	236	186	80	19	22	24	197	65,1	25,4	M16	UCPH212	UC212	PH212
65	140	258	203	85	23	28	26	213	65,1	25,4	M20	UCPH213	UC213	PH213
70	150	266	210	90	23	28	27	227	74,6	30,2	M20	UCPH214	UC214	PH214
75	160	274	217	95	23	28	28	240	77,8	33,3	M20	UCPH215	UC215	PH215
80	170	290	232	100	24	28	30	256	82,6	33,3	M20	UCPH216	UC216	PH216

Note: Inch sizes available on request.

Standard duty pillow blocks pressed steel housing eccentric locking collar type

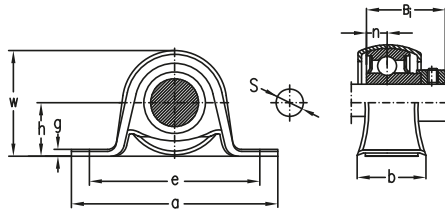

Shaft dia.	Nominal dimensions		e	b	s	g	w	Bi	n	Bolt size	Unit number	Bearing number	Housing number
	h	a											
mm													
12	22,2	86	68	25	9,5	3,2	43,8	28,5	6	M8	SAPP201	SA201	PP203
15	22,2	86	68	25	9,5	3,2	43,8	28,5	6	M8	SAPP202	SA202	PP203
17	22,2	86	68	25	9,5	3,2	43,8	28,5	6	M8	SAPP203	SA203	PP203
20	25,4	98	76	32	9,5	3,2	50,5	29,7	7	M8	SAPP204	SA204	PP204
25	28,6	108	86	32	11,5	4	56,6	30,5	7,5	M10	SAPP205	SA205	PP205
30	33,3	117	95	38	11,5	4	66,3	33,9	8	M10	SAPP206	SA206	PP206
35	39,7	129	106	42	11,5	4,6	78	37,5	8,5	M10	SAPP207	SA207	PP207

Note: Inch sizes available on request.

Standard duty pillow blocks pressed steel housing eccentric locking collar type

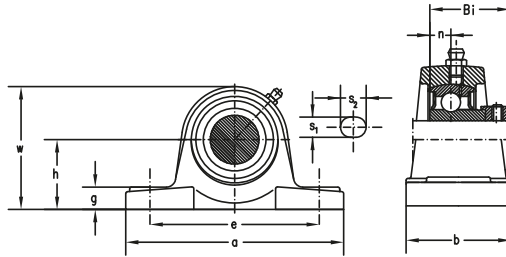

Shaft dia.	Nominal dimensions		b	s ₁	s ₂	g	w	Bi	n	Bolt size	Unit number	Bearing Housing number number		
	h	a										e	number	number
mm													-	
20	31,8	128	98	38	11	14	14	63,0	29,5	7,0	M10	SAAK204	SA204	AK204
25	33,3	140	105	40	11	14	15	66,5	30,5	7,5	M10	SAAK205	SA205	AK205
30	39,7	160	121	44	14	19	17	79	33,9	8	M12	SAAK206	SA206	AK206
35	46	167	127	48	14	19	18	91	37,5	8,5	M12	SAAK207	SA207	AK207
40	49,2	181	140	52	14	19	19	98	40,5	9,5	M12	SAAK208	SA208	AK208
45	52,4	189	146	54	14	19	20	105	42,2	10	M12	SAAK209	SA209	AK209
50	55,6	203	159	57	17,5	21	21	111,5	43,7	10,5	M16	SAAK210	SA210	AK210
55	61,9	232	181	60	18	24	23	123	48,4	11,5	M16	SAAK211	SA211	AK211

Note: Inch sizes available on request.

Standard duty pillow blocks cast housing eccentric locking collar type

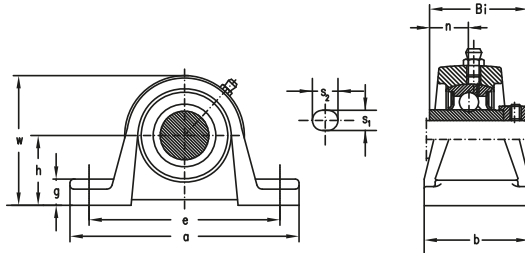

Shaft dia.	Nominal dimensions		e	b	s ₁	s ₂	g	w	Bi	n	Bolt size	Unit number	Bearing Housing number number		
	h	a											number	number	
mm														-	
20	33,3	127	96	35	13	16	14	65	29,5	7	M10	SAP204	SA204	P204	
25	36,5	140	105	36	13	19	15	71	30,5	7,5	M10	SAP205	SA205	P205	
30	42,9	160	121	42	14	19	16	84	33,9	8	M12	SAP206	SA206	P206	
35	47,6	167	127	45	15	19	17	94	37,5	8,5	M12	SAP207	SA207	P207	
40	49,2	180	137	49	15	21	18	100	40,5	9,5	M12	SAP208	SA208	P208	
45	54	189	146	50	15	21	20	107,5	42,2	10	M12	SAP209	SA209	P209	
50	57,2	204	159	56	19	22	21	114	43,7	10,5	M16	SAP210	SA210	P210	
55	63,5	217	172	58	19	22	22	126	48,4	11,5	M16	SAP211	SA211	P211	

Note: Inch sizes available on request.

Standard duty pillow blocks cast housing eccentric locking collar type

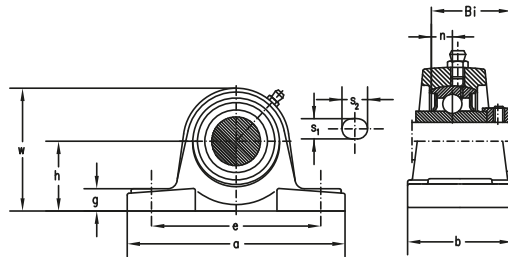

Shaft dia.	Nominal dimensions		b	s ₁	s ₂	g	w	Bi	n	Bolt size	Unit number	Bearing Housing number number		
	h	a										e	number	number
mm													-	
20	31,8	128	98	38	11	14	14	63,0	43,5	17	M10	UELAK204	UEL204	AK204
25	33,3	140	105	40	11	14	15	66,5	44,3	17,4	M10	UELAK205	UEL205	AK205
30	39,7	160	121	44	14	19	17	79,0	48,3	18,2	M12	UELAK206	UEL206	AK206
35	46,0	167	127	48	14	19	18	91,0	51,1	18,8	M12	UELAK207	UEL207	AK207
40	49,2	181	140	52	14	19	19	98,0	56,3	21,4	M12	UELAK208	UEL208	AK208
45	52,4	189	146	54	14	19	20	105,0	56,3	21,4	M12	UELAK209	UEL209	AK209
50	55,6	203	159	57	17,5	21	21	111,5	62,7	24,6	M16	UELAK210	UEL210	AK210
55	61,9	232	181	60	18	24	23	123	71,3	27,7	M16	UELAK211	UEL211	AK211
60	68,3	241	191	64	18	24	25	136	77,7	30,9	M16	UELAK212	UEL212	AK212
65	74,6	262	203	70	21	28	27	147,5	85,7	34,1	M20	UELAK213	UEL213	AK213
70	77,8	266	210	74	21	28	28	153,5	85,7	34,1	M20	UELAK214	UEL214	AK214
75	82,6	304	241	78	21	32	30	162	92,1	37,3	M20	UELAK215	UEL215	AK215

Note: Inch sizes available on request.

Standard duty pillow blocks cast housing eccentric locking collar type

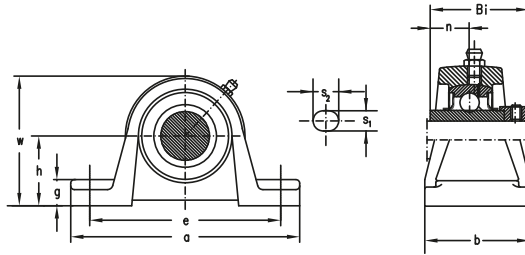

Shaft dia.	Nominal dimensions			b	s ₁	s ₂	g	w	Bi	n	Bolt size	Unit number	Bearing Housing number number		
	h	a	e										number	number	
mm														-	
12	30,2	127	96	38	13	16	11	60,7	43,5	17,0	M10	UELP201	UEL201	P203	
15	30,2	127	96	38	13	16	11	60,7	43,5	17,0	M10	UELP202	UEL202	P203	
17	30,2	127	96	38	13	16	11	60,7	43,5	17,0	M10	UELP203	UEL203	P203	
20	33,3	127	96	35	13	16	14	65,0	43,5	17,0	M10	UELP204	UEL204	P204	
25	36,5	140	105	36	13	19	15	71,0	44,3	17,4	M10	UELP205	UEL205	P205	
30	42,9	160	121	42	14	19	16	84,0	48,3	18,2	M12	UELP206	UEL206	P206	
35	47,6	167	127	45	15	19	17	94,0	51,1	18,8	M12	UELP207	UEL207	P207	
40	49,2	180	137	49	15	21	18	100,0	56,3	21,4	M12	UELP208	UEL208	P208	
45	54	189	146	50	15	21	20	107,5	56,3	21,4	M12	UELP209	UEL209	P209	
50	57,2	204	159	56	19	22	21	114,0	62,7	24,6	M16	UELP210	UEL210	P210	
55	63,5	217	172	58	19	22	22	126	71,3	27,7	M16	UELP211	UEL211	P211	
60	69,9	238	186	64	19	25	24	139	77,7	30,9	M16	UELP212	UEL212	P212	
65	76,2	262	203	70	23	25	26	149	85,7	34,1	M20	UELP213	UEL213	P213	
70	79,4	266	210	72	23	29	27	155	85,7	34,1	M20	UELP214	UEL214	P214	
75	82,6	274	217	74	25	29	28	161,6	92,1	37,3	M20	UELP215	UEL215	P215	

Note: Inch sizes available on request.

Standard duty pillow blocks cast housing adapter type

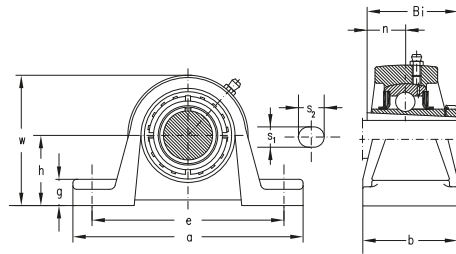

Shaft dia.	Nominal dimensions		e	b	s ₁	s ₂	g	w	Bi	Bolt size	Unit number	Bearing number	Housing number
	h	a											
mm													
20	36,5	140	105	36	13	19	15	71	35	M10	UKP205	UK205	P205
25	42,9	160	121	42	14	19	16	84	38	M12	UKP206	UK206	P206
30	47,6	167	127	45	15	19	17	94	43	M12	UKP207	UK207	P207
35	49,2	180	137	49	15	21	18	100	46	M12	UKP208	UK208	P208
40	54	189	146	50	15	21	20	107,5	50	M12	UKP209	UK209	P209
45	57,2	204	159	56	19	22	21	114	55	M16	UKP210	UK210	P210
50	63,5	217	172	58	19	22	22	126	59	M16	UKP211	UK211	P211
55	69,9	238	186	64	19	25	24	139	62	M16	UKP212	UK212	P212
60	76,2	262	203	70	23	29	26	149	65	M20	UKP213	UK213	P213

Note: Inch sizes available on request.

Standard duty pillow blocks cast housing adapter type

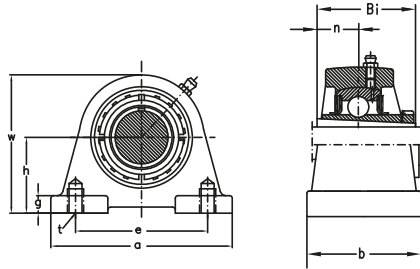

Shaft dia.	Nominal dimensions			b	g	w	f	t	Bi	Bolt size	Unit number	Bearing number	Housing number
	h	a	e										
mm													
20	36,5	84	56	38	12	72	15	M10	35	M10	UKPA205	UK205	PA205
25	42,9	94	66	48	13	84	18	M14	38	M14	UKPA206	UK206	PA206
30	47,6	110	80	48	13	95	20	M14	43	M14	UKPA207	UK207	PA207
35	49,2	116	84	54	13	100	20	M14	46	M14	UKPA208	UK208	PA208
40	54,2	120	90	60	13	108	25	M14	50	M14	UKPA209	UK209	PA209
45	57,2	130	94	60	14	116	25	M16	55	M16	UKPA210	UK210	PA210
50	63,5	140	104	66	14	125	25	M16	59	M16	UKPA211	UK211	PA211
55	69,9	150	114	68	15	138	25	M16	62	M16	UKPA212	UK212	PA212
60	76,2	160	124	70	15	150	25	M16	65	M16	UKPA213	UK213	PA213

Note: Inch sizes available on request.

Medium duty pillow blocks cast housing set screws type

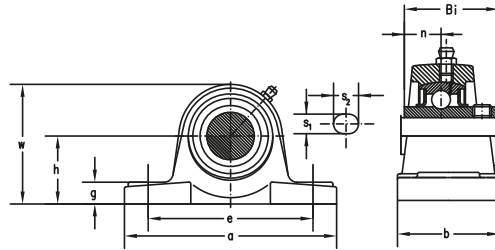

Shaft dia.	Nominal dimensions		b	s ₁	s ₂	g	w	Bi	n	Bolt size	Unit number	Bearing Housing number number		
	h	a										e	number	number
mm													-	
25	44,4	159	119	51	17	20	17	85	38,1	15,9	M14	UCPX05	UCX05	PX05
30	47,6	175	127	54	17	20	20	93	42,9	17,5	M14	UCPX06	UCX06	PX06
35	54	203	144	57	17	20	21	105	49,2	19	M14	UCPX07	UCX07	PX07
40	58,7	222	156	65	20	23	23	112	49,2	19	M16	UCPX08	UCX08	PX08
45	58,7	222	156	67	20	23	25	116	51,6	19	M16	UCPX09	UCX09	PX09
50	63,5	240	171	71	20	23	25	126	55,6	22,2	M16	UCPX10	UCX10	PX10
55	69,8	260	184	79	25	28	29	137	65,1	25,4	M20	UCPX11	UCX11	PX11
60	76,2	280	203	81	25	28	31	149	65,1	25,4	M20	UCPX12	UCX12	PX12
65	76,2	286	203	83	25	28	33	152	74,6	30,2	M20	UCPX13	UCX13	PX13
70	88,9	320	229	85	27	30	34	170	77,8	33,3	M22	UCPX14	UCX14	PX14
75	88,9	330	229	92	27	30	35	175	82,6	33,3	M22	UCPX15	UCX15	PX15
80	101,6	378	283	99	27	30	37	194	85,7	34,1	M22	UCPX16	UCX16	PX16

Note: Inch sizes available on request.

Heavy duty pillow blocks cast housing set screws type

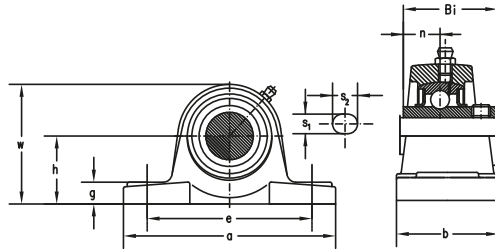

Shaft dia.	Nominal dimensions		e	b	s ₁	s ₂	g	w	Bi	n	Bolt size	Unit number	Bearing Housing number number		
	h	a											UC	P	
mm														-	
25	45	173	132	45	17	20	15	85	38	15	M14	UCP305	UC305	P305	
30	50	180	140	50	17	20	15	95	43	17	M14	UCP306	UC306	P306	
35	56	210	160	56	17	25	19	106	48	19	M14	UCP307	UC307	P307	
40	60	218	170	62	18	25	19	116	52	19	M14	UCP308	UC308	P308	
45	67	244	190	66	20	26	23	129	57	22	M16	UCP309	UC309	P309	
50	75	271	212	74	20	30	26	143	61	22	M16	UCP310	UC310	P310	
55	80	300	236	80	20	32	29	154	66	25	M16	UCP311	UC311	P311	
60	85	325	250	85	23	35	31	164	71	26	M20	UCP312	UC312	P312	
65	90	335	260	90	25	38	33	176	75	30	M20	UCP313	UC313	P313	
70	95	360	280	93	27	40	34	187	78	33	M22	UCP314	UC314	P314	
75	100	380	290	100	27	40	35	198	82	32	M22	UCP315	UC315	P315	
80	106	400	300	105	27	40	37	210	86	34	M22	UCP316	UC316	P316	

Note: Inch sizes available on request.

Standard duty flanged units cast housing set screws type

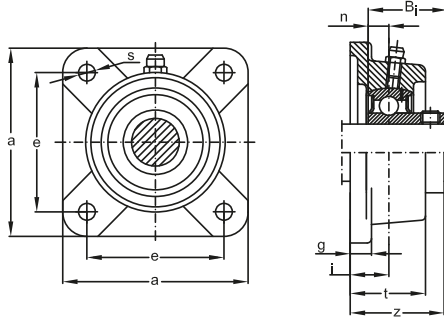

Shaft Nominal dia.	Nominal dimensions										Bolt size	Unit number	Bearing number	Housing number
	a	e	i	g	t	s	z	Bi	n					
mm												-		
20	86	63,5	19	15	29,5	11,5	37,0	25	7,0	M10	SBFS204	SB204	FS204	
25	93	70,0	19	15	30,0	11,5	38,5	27	7,5	M10	SBFS205	SB205	FS205	
30	106	82,5	20	16	32,5	13,0	41,0	29	8,0	M12	SBFS206	SB206	FS206	
35	116	92,0	21	17	35,0	13,0	44,5	32	8,5	M12	SBFS207	SB207	FS207	
40	129	101,5	24	17	39,0	14,0	48,5	34	9,5	M12	SBFS208	SB208	FS208	

Note: Inch sizes available on request.

Standard duty flanged units cast housing set screws type

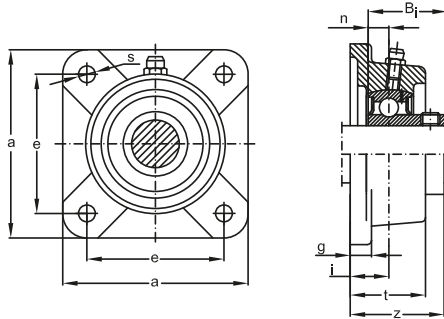

**Shaft Nominal
dia. dimensions**

a e i g t s z Bi n

**Bolt Unit Bearing Housing
size number number number**

mm

	a	e	i	g	t	s	z	Bi	n	Bolt size	Unit number	Bearing number	Housing number
20	86	64	15	12	25,5	12	33,0	25	7,0	M10	SBF204	SB204	F204
25	95	70	16	13	27,0	12	35,5	27	7,5	M10	SBF205	SB205	F205
30	108	83	18	13	31,0	12	39,0	29	8,0	M10	SBF206	SB206	F206
35	117	92	19	15	34,0	14	42,5	32	8,5	M12	SBF207	SB207	F207
40	130	102	21	15	36,0	16	45,5	34,0	9,5	M14	SBF208	SB208	F208

Note: Inch sizes available on request.

Standard duty flanged units cast housing set screws type

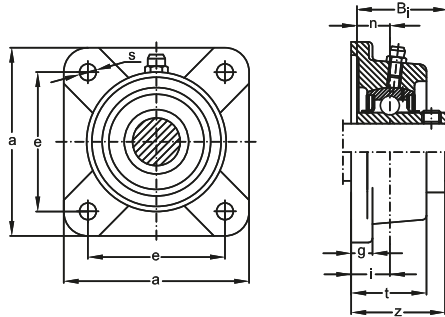

Shaft Nominal dia.	Nominal dimensions										Bolt size	Unit number	Bearing number	Housing number
	a	e	i	g	t	s	z	Bi	n					
mm														
20	86	63,5	19	15	29,5	11,5	37,3	31,0	12,7	M10	UCFS204	UC204	FS204	
25	93	70,0	19	15	30,0	11,5	38,7	34,0	14,3	M10	UCFS205	UC205	FS205	
30	106	82,5	20	16	32,5	13,0	42,2	38,1	15,9	M12	UCFS206	UC206	FS206	
35	116	92,0	21	17	35,0	13,0	46,4	42,9	17,5	M12	UCFS207	UC207	FS207	
40	129	101,5	24	17	39,0	14,0	54,2	49,2	19,0	M12	UCFS208	UC208	FS208	
45	135	105,0	24	18	40,0	16,0	54,2	49,2	19,0	M14	UCFS209	UC209	FS209	
50	143	111,0	28	20	45,0	16,0	60,6	51,6	19,0	M14	UCFS210	UC210	FS210	
55	162	130,0	31	21	49,0	17,0	64,4	55,6	22,2	M14	UCFS211	UC211	FS211	
60	175	143,0	34	22	53,5	17,0	73,7	65,1	25,4	M14	UCFS212	UC212	FS212	
65	184	149,0	38	22	58,0	18,0	77,7	65,1	25,4	M16	UCFS213	UC213	FS213	
70	188	152,0	38	23	60,0	18,0	82,4	74,6	30,2	M16	UCFS214	UC214	FS214	
75	200	152,4	41	24	62,0	20,0	85,5	77,8	33,3	M16	UCFS215	UC215	FS215	

Note: Inch sizes available on request.

Standard duty flanged units cast housing set screws type

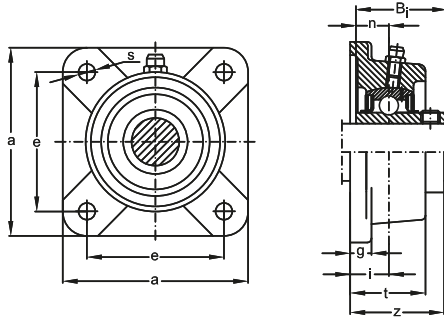

Shaft Nominal dia.	Dimensions			g	t	s	z	Bi	n	Bolt size	Unit number	Bearing number	Housing number
	a	e	i										
mm													
12	86	64	15	12	25,5	12	33,3	31,0	12,7	M10	UCF201	UC201	F204
15	86	64	15	12	25,5	12	33,3	31,0	12,7	M10	UCF202	UC202	F204
17	86	64	15	12	25,5	12	33,3	31,0	12,7	M10	UCF203	UC203	F204
20	86	64	15	12	25,5	12	33,3	31,0	12,7	M10	UCF204	UC204	F204
25	95	70	16	13	27	12	35,7	34,0	14,3	M10	UCF205	UC205	F205
30	108	83	18	13	31	12	40,2	38,1	15,9	M10	UCF206	UC206	F206
35	117	92	19	15	34	14	44,4	42,9	17,5	M12	UCF207	UC207	F207
40	130	102	21	15	36	16	51,2	49,2	19	M14	UCF208	UC208	F208
45	137	105	22	16	38	16	52,2	49,2	19	M14	UCF209	UC209	F209
50	143	111	22	16	40	16	54,6	51,6	19	M14	UCF210	UC210	F210
55	162	130	25	18	43	19	58,4	55,6	22,2	M16	UCF211	UC211	F211
60	175	143	29	18	48	19	68,7	65,1	25,4	M16	UCF212	UC212	F212
65	187	149	30	22	50	19	69,7	65,1	25,4	M16	UCF213	UC213	F213
70	193	152	31	22	54	19	75,4	74,6	30,2	M16	UCF214	UC214	F214
75	200	159	34	22	56	19	78,5	77,8	33,3	M16	UCF215	UC215	F215
80	208	165	34	24	58	23	83,3	82,6	33,3	M20	UCF216	UC216	F216
85	220	175	36	26	63	23	87,6	85,7	34,1	M20	UCF217	UC217	F217
90	235	187	40	26	68	23	96,3	96,0	39,7	M20	UCF218	UC218	F218

Note: Inch sizes available on request.

Standard duty flanged units cast housing eccentric locking collar type

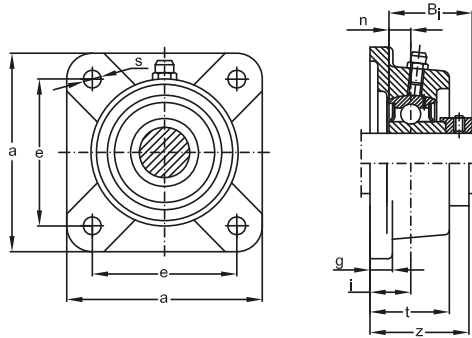

**Shaft Nominal
dia. dimensions**
a e i g t s z Bi n

**Bolt Unit Bearing Housing
size number number number**

	a	e	i	g	t	s	z	Bi	n				
mm										-			
20	86	63,5	19	15	29,5	11,5	41,5	29,5	7,0	M10	SAFS204	SA204	FS204
25	93	70,0	19	15	30,0	11,5	42,0	30,5	7,5	M10	SAFS205	SA205	FS205
30	106	82,5	20	16	32,5	13,0	45,9	33,9	8,0	M12	SAFS206	SA206	FS206
35	116	92,0	21	17	35,0	13,0	50,0	37,5	8,5	M12	SAFS207	SA207	FS207
40	129	101,5	24	17	39,0	14,0	55,0	40,5	9,5	M12	SAFS208	SA208	FS208
45	135	105,0	24	18	40,0	16,0	56,2	42,2	10,0	M14	SAFS209	SA209	FS209
50	143	111,0	28	20	45,0	16,0	61,2	43,7	10,5	M14	SAFS210	SA210	FS210
55	162	130,0	31	21	49,0	17,0	67,9	48,4	11,5	M14	SAFS211	SA211	FS211

Note: Inch sizes available on request.

Standard duty flanged units cast housing eccentric locking collar type

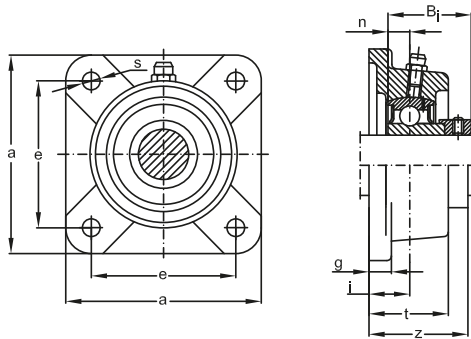

**Shaft Nominal
dia. dimensions**
a e i g t s z Bi n

**Bolt Unit Bearing Housing
size number number number**

	a	e	i	g	t	s	z	Bi	n				
mm										-			
20	86	64	15	12	25,5	12	37,5	29,5	7,0	M10	SAF204	SA204	F204
25	95	70	16	13	27,0	12	39,0	30,5	7,5	M10	SAF205	SA205	F205
30	108	83	18	13	31,0	12	43,9	33,9	8,0	M10	SAF206	SA206	F206
35	117	92	19	15	34,0	14	48,0	37,5	8,5	M12	SAF207	SA207	F207
40	130	102	21	15	36,0	16	52,0	40,5	9,5	M14	SAF208	SA208	F208
45	137	105	22	16	38,0	16	54,2	42,2	10,0	M14	SAF209	SA209	F209
50	143	111	22	16	40,0	16	55,2	43,7	10,5	M14	SAF210	SA210	F210
55	162	130	25	18	43,0	19	61,9	48,4	11,5	M16	SAF211	SA211	F211

Note: Inch sizes available on request.

Standard duty flanged units cast housing eccentric locking collar type

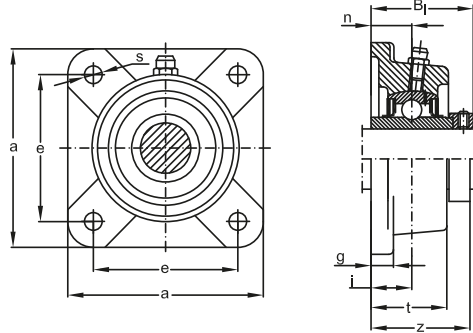

**Shaft Nominal
dia. dimensions**
a e i g t s z Bi n

**Bolt Unit Bearing Housing
size number number number**

mm											-		
20	86	63,5	19	15	29,5	11,5	45,5	43,5	17	M10	UELFS204	UEL204	FS204
25	93	70	19	15	30	11,5	45,9	44,3	17,4	M10	UELFS205	UEL205	FS205
30	106	82,5	20	16	32,5	13,0	50,1	48,3	18,2	M12	UELFS206	UEL206	FS206
35	116	92	21	17	35	13	53,3	51,1	18,8	M12	UELFS207	UEL207	FS207
40	129	101,5	24	17	39	14	58,9	56,3	21,4	M12	UELFS208	UEL208	FS208
45	135	105	24	18	40	16	58,9	56,3	21,4	M14	UELFS209	UEL209	FS209
50	143	111	28	20	45	16	66,1	62,7	24,6	M14	UELFS210	UEL210	FS210
55	162	130	31	21	49	17	74,6	71,3	27,7	M14	UELFS211	UEL211	FS211
60	175	143	34	22	53,5	17	80,8	77,7	30,9	M14	UELFS212	UEL212	FS212
65	184	149	38	22	58	18	89,6	85,7	34,1	M16	UELFS213	UEL213	FS213
70	188	152	38	23	60	18	89,6	85,7	34,1	M16	UELFS214	UEL214	FS214
75	200	152,4	41	24	62	20	95,8	92,1	37,3	M16	UELFS215	UEL215	FS215

Note: Inch sizes available on request.

Standard duty flanged units cast housing eccentric locking collar type

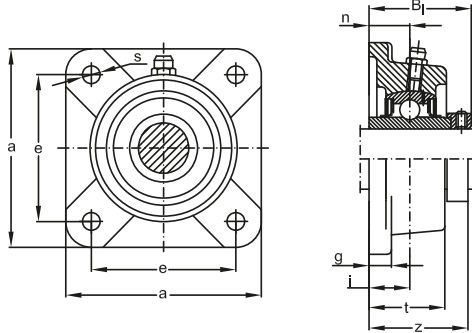

**Shaft Nominal
dia. dimensions**

a e i g t s z Bi n

**Bolt Unit Bearing Housing
size number number number**

mm

	a	e	i	g	t	s	z	Bi	n				
12	86	64	15	12	25,5	12	41,5	43,5	17	M10	UEL201	UEL201	F204
15	86	64	15	12	25,5	12	41,5	43,5	17	M10	UEL202	UEL202	F204
17	86	64	15	12	25,5	12	41,5	43,5	17	M10	UEL203	UEL203	F204
20	86	64	15	12	25,5	12	41,5	43,5	17	M10	UEL204	UEL204	F204
25	95	70	16	13	27	12	42,9	44,3	17,4	M10	UEL205	UEL205	F205
30	108	83	18	13	31	12	48,1	48,3	18,2	M10	UEL206	UEL206	F206
35	117	92	19	15	34	14	51,3	51,1	18,8	M12	UEL207	UEL207	F207
40	130	102	21	15	36	16	55,9	56,3	21,4	M14	UEL208	UEL208	F208
45	137	105	22	16	38	16	56,9	56,3	21,4	M14	UEL209	UEL209	F209
50	143	111	22	16	40	16	60,1	62,7	24,6	M14	UEL210	UEL210	F210
55	162	130	25	18	43	19	68,6	71,3	27,7	M16	UEL211	UEL211	F211
60	175	143	29	18	48	19	75,8	77,7	30,9	M16	UEL212	UEL212	F212
65	187	149	30	22	50	19	81,6	85,7	34,1	M16	UEL213	UEL213	F213
70	193	152	31	22	54	19	82,6	85,7	34,1	M16	UEL214	UEL214	F214
75	200	159	34	22	56	19	88,8	92,1	37,3	M16	UEL215	UEL215	F215

Note: Inch sizes available on request.

Standard duty flanged units cast housing adapter type

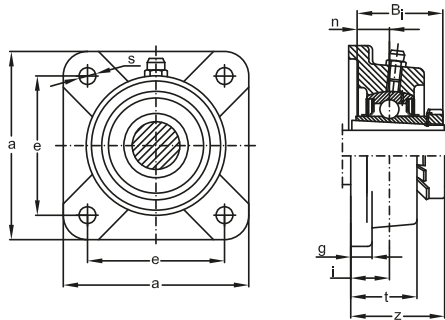

**Shaft Nominal
dia. dimensions**

a e i g t s z Bi n

**Bolt Unit Bearing Housing
size number number number**

	a	e	i	g	t	s	z	Bi	n	Bolt size	Unit number	Bearing number	Housing number
mm										-			
20	95	70	16	13	27	12	35,5	35		M10	UKF205	UK205	F205
25	108	83	18	13	31	12	39,0	38		M10	UKF206	UK206	F206
30	117	92	19	15	34	14	42,5	43		M12	UKF207	UK207	F207
35	130	102	21	15	36	16	46,5	46		M14	UKF208	UK208	F208
40	137	105	22	16	38	16	48,5	50		M14	UKF209	UK209	F209
45	143	111	22	16	40	16	50,0	55		M14	UKF210	UK210	F210
50	162	130	25	18	43	19	54,5	59		M16	UKF211	UK211	F211
55	175	143	29	18	48	19	61,0	62		M16	UKF212	UK212	F212
60	187	149	30	22	50	19	64,0	65		M16	UKF213	UK213	F213

Medium duty flanged units cast housing set screws type

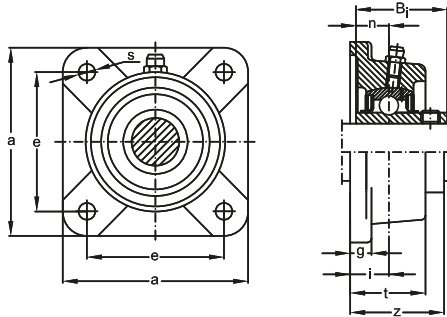

Shaft Nominal dia.	Nominal dimensions									Bolt size	Unit number	Bearing number	Housing number
	a	e	i	g	t	s	z	Bi	n				
mm													
25	108	82,5	18	13	30	12	40,2	38,1	15,9	M10	UCFX05	UCX05	FX05
30	117	92,0	19	14	34	16	44,4	42,9	17,5	M14	UCFX06	UCX06	FX06
35	130	101,5	21	14	38	16	51,2	49,2	19,0	M14	UCFX07	UCX07	FX07
40	137	105,0	22	14	40	19	52,2	49,2	19,0	M16	UCFX08	UCX08	FX08
45	143	111,0	23	14	40	19	55,6	51,6	19,0	M16	UCFX09	UCX09	FX09
50	162	130,0	26	20	44	19	59,4	55,6	22,2	M16	UCFX10	UCX10	FX10
55	175	143,0	29	20	49	19	68,7	65,1	25,4	M16	UCFX11	UCX11	FX11
60	187	149	34	21	59	19	73,7	65,1	25,4	M16	UCFX12	UCX12	FX12
65	187	149	34	21	59	19	78,4	74,6	30,2	M18	UCFX13	UCX13	FX13
70	197	152	37	24	60	23	81,5	77,8	33,3	M20	UCFX14	UCX14	FX14
75	197	152	40	24	68	23	89,3	82,6	33,3	M20	UCFX15	UCX15	FX15
80	214	171	40	24	70	23	91,6	85,7	34,1	M20	UCFX16	UCX16	FX16

Note: Inch sizes available on request.

Heavy duty flanged units cast housing set screws type

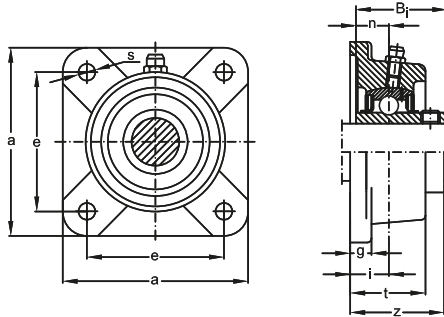

Shaft Nominal dia.	Dimensions										Bolt size	Unit number	Bearing number	Housing number
	a	e	i	g	t	s	z	Bi	n					
mm														
25	108	80	16	13	29	16	39	38	15	M14	UCF305	UC305	F305	
30	125	95	18	15	32	16	44	43	17	M14	UCF306	UC306	F306	
35	135	100	20	16	36	19	49	48	19	M16	UCF307	UC307	F307	
40	150	112	23	17	40	19	56	52	19	M16	UCF308	UC308	F308	
45	160	125	25	18	44	19	60	57	22	M16	UCF309	UC309	F309	
50	175	132	28	20	48	23	67	61	22	M20	UCF310	UC310	F310	
55	185	140	30	20	52	23	71	66	25	M20	UCF311	UC311	F311	
60	193	150	33	22	56	23	78	71	26	M20	UCF312	UC312	F312	
65	208	166	33	22	58	23	78	75	30	M20	UCF313	UC313	F313	
70	226	178	36	25	61	25	81	78	33	M22	UCF314	UC314	F314	
75	236	184	39	25	66	25	89	82	32	M22	UCF315	UC315	F315	
80	250	196	38	27	68	31	90	86	34	M27	UCF316	UC316	F316	

Note: Inch sizes available on request.

Standard duty two bolts flanged units pressed steel housing set screws type

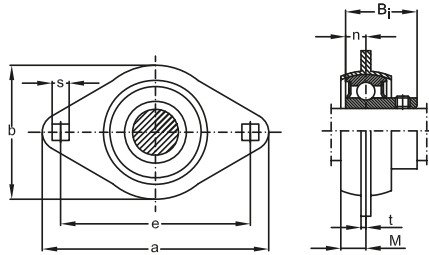

Shaft dia.	Nominal dimensions			t	s	b	Bi	n	Bolt size	Unit number	Bearing number	Housing number
	a	e	M									
mm												
12	81	63,5	7,0	2,0	7,1	59	22	6	M6	SBPFL201	SB201	PFL203
15	81	63,5	7,0	2,0	7,1	59	22	6	M6	SBPFL202	SB202	PFL203
17	81	63,5	7,0	2,0	7,1	59	22	6	M6	SBPFL203	SB203	PFL203
20	90	71,5	8,0	2,0	9	67	25	7	M8	SBPFL204	SB204	PFL204
25	95	76,0	9,0	2,0	9	71	27	7,5	M8	SBPFL205	SB205	PFL205
30	113	90,5	9,5	2,6	11	84	29	8	M10	SBPFL206	SB206	PFL206
35	122	100	11	2,6	11	94	32	8,5	M10	SBPFL207	SB207	PFL207

Note: Inch sizes available on request.

Standard duty two bolts flanged units cast housing set screws type

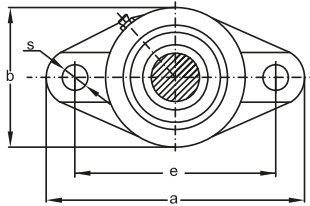

Shaft dia.	Nominal dimensions											Bolt size	Unit number	Bearing number	Housing number
	a	e	i	g	t	s	b	z	Bi	n					
mm															
20	112,5	90	19	15	29,5	10	61	37	25	7	M8	SBFT204	SB204	FT204	
25	123	99	19	15	30	11,5	70	38,5	27	7,5	M10	SBFT205	SB205	FT205	
30	142	116,5	20	16	32,5	11,5	82	41	29	8	M10	SBFT206	SB206	FT206	
35	158	130	21	17	36	13	94	44,5	32	8,5	M10	SBFT207	SB207	FT207	
40	172	143,5	24	17	39	13	103	48,5	34	9,5	M10	SBFT208	SB208	FT208	

Note: Inch sizes available on request.

Standard duty two bolts flanged units cast housing set screws type

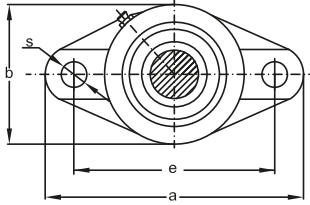

Shaft dia.	Nominal dimensions										Bolt size	Unit number	Bearing number	Housing number
	a	e	i	g	t	s	b	z	Bi	n				
mm											-			
20	113	90	15	11	25,5	12	60	33	25	7	M10	SBFL204	SB204	FL204
25	130	99	16	13	27	16	68	35,5	27	7,5	M14	SBFL205	SB205	FL205
30	148	117	18	13	31	16	80	39	29	8	M14	SBFL206	SB206	FL206
35	161	130	19	14	34	16	90	42,5	32	8,5	M14	SBFL207	SB207	FL207
40	175	144	21	14	36	16	100	45,5	34	9,5	M14	SBFL208	SB208	FL208

Note: Inch sizes available on request.

Standard duty two bolts flanged units cast housing set screws type

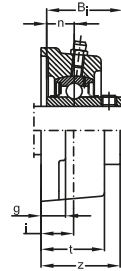
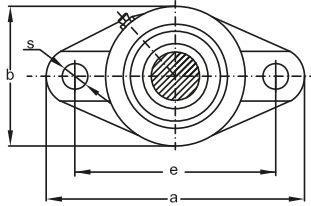

Shaft dia.	Nominal dimensions		i	g	t	s	b	z	Bi	n	Bolt size	Unit number	Bearing number	Housing number
	a	e												
mm														
20	112,5	90	19	15	29,5	10	61	37,3	31	12,7	M8	UCFT204	UC204	FT204
25	123	99	19	15	30	11,5	70	38,7	34	14,3	M10	UCFT205	UC205	FT205
30	142	116,5	20	16	32,5	11,5	82	42,2	38,1	15,9	M10	UCFT206	UC206	FT206
35	158	130	21	17	36	13	94	46,4	42,9	17,5	M10	UCFT207	UC207	FT207
40	172	143,5	24	17	39	13	103	54,2	49,2	19	M10	UCFT208	UC208	FT208
45	180	148,5	24	18	40	15	108	54,2	49,2	19	M12	UCFT209	UC209	FT209
50	190	157	28	20	45	15	114	60,6	51,6	19	M12	UCFT210	UC210	FT210
55	217	184	31	21	48	16,5	128	64,4	55,6	22,2	M14	UCFT211	UC211	FT211
60	237	202	34	21	53	16,5	138	73,7	65,1	25,4	M14	UCFT212	UC212	FT212
65	256	210	38	22	56	21	152	77,7	65,1	25,4	M20	UCFT213	UC213	FT213
70	264	216	38	23	58	21	157	82,4	74,6	30,2	M20	UCFT214	UC214	FT214

Note: Inch sizes available on request.

Standard duty two bolts flanged units cast housing set screws type

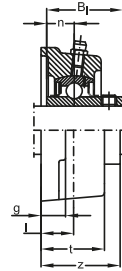
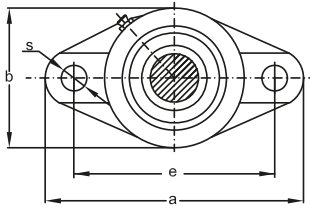

Shaft dia.	Nominal dimensions		i	g	t	s	b	z	Bi	n	Bolt size	Unit number	Bearing number	Housing number
	a	e												
mm														
12	113	90	15	11	25,5	12	60	33,3	31	12,7	M10	UCFL201	UC201	FL201
15	113	90	15	11	25,5	12	60	33,3	31	12,7	M10	UCFL202	UC202	FL202
17	113	90	15	11	25,5	12	60	33,3	31	12,7	M10	UCFL203	UC203	FL203
20	113	90	15	11	25,5	12	60	33,3	31	12,7	M10	UCFL204	UC204	FL204
25	130	99	16	13	27	16	68	35,7	34	14,3	M14	UCFL205	UC205	FL205
30	148	117	18	13	31	16	80	40,2	38,1	15,9	M14	UCFL206	UC206	FL206
35	161	130	19	14	34	16	90	44,4	42,9	17,5	M14	UCFL207	UC207	FL207
40	175	144	21	14	36	16	100	51,2	49,2	19	M14	UCFL208	UC208	FL208
45	188	148	22	16	38	19	108	52,2	49,2	19	M16	UCFL209	UC209	FL209
50	197	157	22	16	40	19	115	54,6	51,6	19	M16	UCFL210	UC210	FL210
55	224	184	25	18	43	19	130	58,4	55,6	22,2	M16	UCFL211	UC211	FL211
60	250	202	29	18	48	23	140	68,7	65,1	25,4	M20	UCFL212	UC212	FL212
65	258	210	30	20	50	23	155	69,7	65,1	25,4	M20	UCFL213	UC213	FL213
70	265	216	31	20	54	23	160	75,4	74,6	30,2	M20	UCFL214	UC214	FL214
75	275	225	34	20	56	23	165	78,5	77,8	33,3	M20	UCFL215	UC215	FL215
80	290	233	34	22	58	25	180	83,3	82,6	33,3	M22	UCFL216	UC216	FL216
85	305	248	36	22	63	25	190	87,6	85,7	34,1	M22	UCFL217	UC217	FL217
90	320	265	40	23	68	25	205	96,3	96	39,7	M22	UCFL218	UC218	FL218

Note: Inch sizes available on request.

Standard duty flanged units cast housing special type set screws type

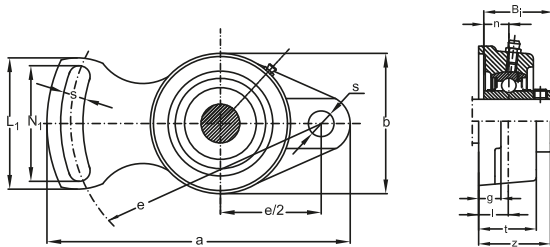

Shaft dia.	Nominal dimensions										Bolt size	Unit number	Bearing Housing number number			
	a	e	i	g	t	s	N ₁	b	L ₁	z			Bi	n		
mm															-	
12	102	78	15	12	25,5	10	40	60	54	33,3	31	12,7	M8	UCFA201	UC201	FA201
15	102	78	15	12	25,5	10	40	60	54	33,3	31	12,7	M8	UCFA202	UC202	FA202
17	102	78	15	12	25,5	10	40	60	54	33,3	31	12,7	M8	UCFA203	UC203	FA203
20	102	78	15	12	25,5	10	40	60	54	33,3	31	12,7	M8	UCFA204	UC204	FA204
25	125	98	16	14	27	12	51	68	65	34,7	34	14,3	M10	UCFA205	UC205	FA205
30	144	117	18	14	31	12	58	80	72	40,2	38,1	15,9	M10	UCFA206	UC206	FA206
35	161	130	19	16	34	14	66	90	82	45,4	42,9	17,5	M12	UCFA207	UC207	FA207
40	175	144	21	16	36	14	71	100	87	52,2	49,2	19	M12	UCFA208	UC208	FA208
45	178	146	22	16	38	16	72	108	88	52,2	49,2	19	M14	UCFA209	UC209	FA209
50	188	155	22	16	39	16	75	114	92	54,6	51,6	19	M14	UCFA210	UC210	FA210
55	216	182	25	18	42,5	16	84	128	102	58,4	55,6	22,2	M14	UCFA211	UC211	FA211
60	238	202	29	19	47,5	18	104	140	122	68,7	65,1	25,4	M16	UCFA212	UC212	FA212
65	248	210	30	20	49	18	106	152	126	69,7	65,1	25,4	M16	UCFA213	UC213	FA213

Note: Inch sizes available on request.

Standard duty flanged units cast housing special type set screws type

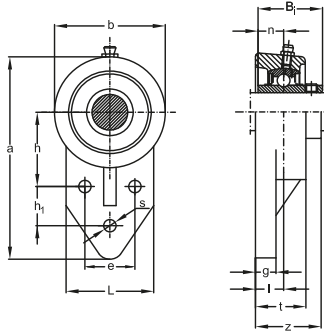

Shaft dia.	Nominal dimensions	Bolt size	Unit number	Bearing number	Housing number
a	e i g t s h h ₁ L b z	Bi	n		

mm

12	109 32 15 11 25,5 10 42 27 52 60 33,3 31	12,7 M8	-	UCFB201	UC201	FB201
15	109 32 15 11 25,5 10 42 27 52 60 33,3 31	12,7 M8	-	UCFB202	UC202	FB202
17	109 32 15 11 25,5 10 42 27 52 60 33,3 31	12,7 M8	-	UCFB203	UC203	FB203
20	109 32 15 11 25,5 10 42 27 52 60 33,3 31	12,7 M8	-	UCFB204	UC204	FB204
25	116 34 16 13 27 10 45 27 56 68 35,7 34	14,3 M8	-	UCFB205	UC205	FB205
30	132 40 18 13 31 10 50 29 65 80 40,2 38,1	15,9 M8	-	UCFB206	UC206	FB206
35	144 46 19 14 33 10 55 32 70 90 44,4 42,9	17,5 M8	-	UCFB207	UC207	FB207
40	164 50 21 16 35 12 60 41 78 100 51,2 49,2	19 M10	-	UCFB208	UC208	FB208
45	175 54 22 16 38 12 65 43 80 108 52,2 49,2	19 M10	-	UCFB209	UC209	FB209
50	184 58 22 16 39 12 68 46 86 114 54,6 51,6	19 M10	-	UCFB210	UC210	FB210
55	207 62 25 18 42,5 14 78 50 90 128 58,4 55,6	22,2 M12	-	UCFB211	UC211	FB211
60	224 66 29 19 47,5 14 84 55 94 140 68,7 65,1	25,4 M12	-	UCFB212	UC212	FB212
65	244 70 30 20 49 14 92 60 102 152 69,7 65,1	25,4 M12	-	UCFB213	UC213	FB213

Note: Inch sizes available on request.

Standard duty two bolts flanged units pressed steel housing eccentric locking collar type

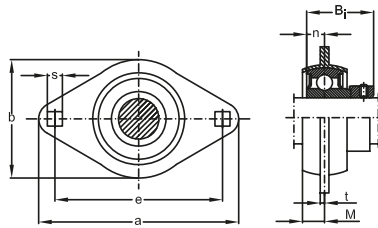

Shaft dia.	Nominal dimensions			t	s	b	Bi	n	Bolt size	Unit number	Bearing number	Housing number
	a	e	M									
mm												
12	81	63,5	7	2	7,1	59	28,5	6	M6	SAPFL201	SA201	PFL201
15	81	63,5	7	2	7,1	59	28,5	6	M6	SAPFL202	SA202	PFL202
17	81	63,5	7	2	7,1	59	28,5	6	M6	SAPFL203	SA203	PFL203
20	90	71,5	8	2	9	67	29,5	7	M8	SAPFL204	SA204	PFL204
25	95	76	9	2	9	71	30,5	7,5	M8	SAPFL205	SA205	PFL205
30	113	90,5	9,5	2,6	11	84	33,9	8	M10	SAPFL206	SA206	PFL206
35	122	100	11	2,6	11	94	37,5	8,5	M10	SAPFL207	SA207	PFL207

Note: Inch sizes available on request.

Standard duty two bolts flanged units cast housing eccentric locking collar type

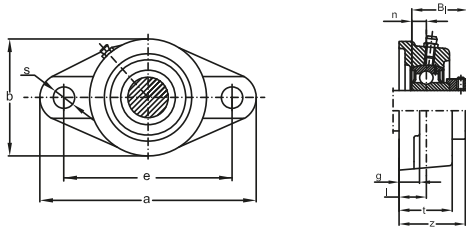

Shaft dia.	Nominal dimensions										Bolt size	Unit number	Bearing Housing	
	a	e	i	g	t	s	b	z	Bi	n			number	number
mm													-	
20	112,5	90	19	15	29,5	10	61	41,5	29,5	7	M8	SAFT204	SA204	FT204
25	123	99	19	15	30	11,5	70	42	30,5	7,5	M10	SAFT205	SA205	FT205
30	142	116,5	20	16	32,5	11,5	82	45,9	33,0	8	M10	SAFT206	SA206	FT206
35	158	130	21	17	36	13	94	50	37,5	8,5	M10	SAFT207	SA207	FT207
40	172	143,5	24	17	39	13	103	55	40,5	9,5	M10	SAFT208	SA208	FT208
45	180	148,5	24	18	40	15	108	56,2	42,2	10	M12	SAFT209	SA209	FT209
50	190	157	28	20	45	15	114	61,2	43,7	10,5	M12	SAFT210	SA210	FT210
55	217	184	31	21	48	16,5	128	67,9	48,4	11,5	M14	SAFT211	SA211	FT211

Note: Inch sizes available on request.

Standard duty two bolts flanged units cast housing eccentric locking collar type

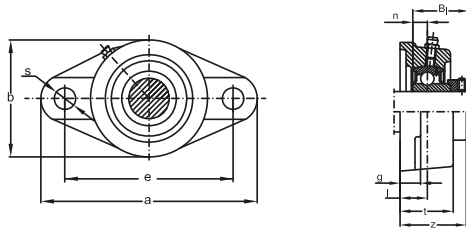

Shaft dia.	Nominal dimensions											Bolt size	Unit number	Bearing Housing	
	a	e	i	g	t	s	b	z	Bi	n	number			number	
mm														-	
20	113	90	15	11	25,5	12	60	37,5	29,5	7	M10	SAFL204	SA204	FL204	
25	130	99	16	13	27	16	68	39	30,5	7,5	M14	SAFL205	SA205	FL205	
30	148	117	18	13	31	16	80	43,9	33,9	8	M14	SAFL206	SA206	FL206	
35	161	130	19	14	34	16	90	48	37,5	8,5	M14	SAFL207	SA207	FL207	
40	175	144	21	14	36	16	100	52	40,5	9,5	M14	SAFL208	SA208	FL208	
45	188	148	22	16	38	19	108	54,2	42,2	10	M16	SAFL209	SA209	FL209	
50	197	157	22	16	40	19	115	55,2	43,7	10,5	M16	SAFL210	SA210	FL210	
55	224	184	25	18	43	19	130	61,9	48,4	11,5	M16	SAFL211	SA211	FL211	

Note: Inch sizes available on request.

Standard duty two bolts flanged units cast housing eccentric locking collar type

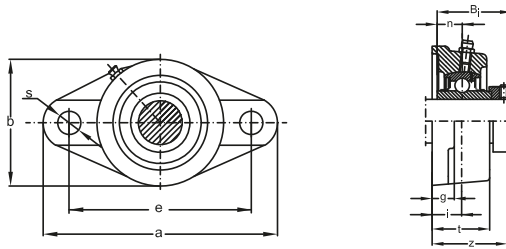

Shaft dia.	Nominal dimensions										Bolt size	Unit number	Bearing number	Housing number	
	a	e	i	g	t	s	b	z	Bi	n					
mm															
20	112,5	90	19	15	29,5	10	61	45,5	43,5	17	M8	UELFT204	UEL204	FT204	
25	123	99	19	15	30	11,5	70	45,9	44,3	17,4	M10	UELFT205	UEL205	FT205	
30	142	116,5	20	16	32,5	11,5	82	50,1	48,3	18,2	M10	UELFT206	UEL206	FT206	
35	158	130	21	17	36	13	94	53,3	51,1	18,8	M10	UELFT207	UEL207	FT207	
40	172	143,5	24	17	39	13	103	58,9	56,3	21,4	M10	UELFT208	UEL208	FT208	
45	180	148,5	24	18	40	15	108	58,9	56,3	21,4	M12	UELFT209	UEL209	FT209	
50	190	157	28	20	45	15	114	66,1	62,7	24,6	M12	UELFT210	UEL210	FT210	
55	217	184	31	21	48	16,5	128	74,6	71,3	27,7	M14	UELFT211	UEL211	FT211	
60	237	202	34	21	53	16,5	138	80,8	77,7	30,9	M14	UELFT212	UEL212	FT212	
65	256	210	38	22	56	21	152	89,6	85,7	34,1	M20	UELFT213	UEL213	FT213	
70	264	216	38	23	58	21	157	89,6	85,7	34,1	M20	UELFT214	UEL214	FT214	

Note: Inch sizes available on request.

Standard duty two bolts flanged units cast housing eccentric locking collar type

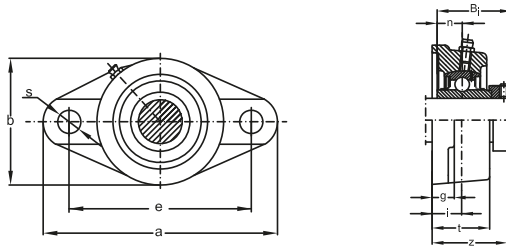

Shaft dia.	Nominal dimensions										Bolt size	Unit number	Bearing number	Housing number
	a	e	i	g	t	s	b	z	Bi	n				
mm														
12	113	90	15	11	25,5	60	12	41,5	43,5	17	M10	UELFL201	UEL201	FL201
15	113	90	15	11	25,5	60	12	41,5	43,5	17	M10	UELFL202	UEL202	FL202
17	113	90	15	11	25,5	60	12	41,5	43,5	17	M10	UELFL203	UEL203	FL203
20	113	90	15	11	25,5	60	12	41,5	43,5	17	M10	UELFL204	UEL204	FL204
25	130	99	16	13	27	68	16	42,9	44,3	17,4	M14	UELFL205	UEL205	FL205
30	148	117	18	13	31	80	16	48,1	48,3	18,2	M14	UELFL206	UEL206	FL206
35	161	130	19	14	34	90	16	51,3	51,1	18,8	M14	UELFL207	UEL207	FL207
40	175	144	21	14	36	100	16	55,9	56,3	21,4	M14	UELFL208	UEL208	FL208
45	188	148	22	16	38	108	19	56,9	56,3	21,4	M16	UELFL209	UEL209	FL209
50	197	157	22	16	40	115	19	60,1	62,7	24,6	M16	UELFL210	UEL210	FL210
55	224	184	25	18	43	130	19	68,6	71,3	27,7	M16	UELFL211	UEL211	FL211
60	250	202	29	18	48	140	23	75,8	77,3	30,9	M20	UELFL212	UEL212	FL212
65	258	210	30	20	50	155	23	81,6	85,7	34,1	M20	UELFL213	UEL213	FL213
70	265	216	31	20	54	160	23	82,6	85,7	34,1	M20	UELFL214	UEL214	FL214
75	275	255	34	20	56	165	23	88,8	92,1	37,3	M20	UELFL215	UEL215	FL215

Note: Inch sizes available on request.

Standard duty two bolts flanged units cast housing adapter type

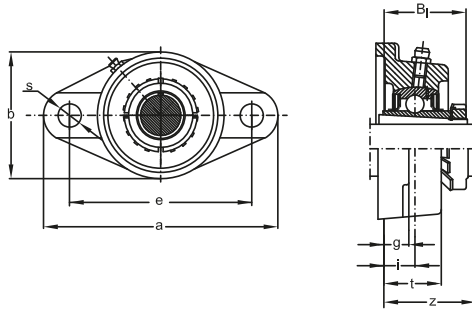

Shaft dia.	Nominal dimensions										Bolt size	Unit number	Bearing number	Housing number
	a	e	i	g	t	b	s	z	Bi					
mm														
20	130	99	16	13	27	68	16	35,5	35	M14	UKFL205	UK205	FL205	
25	148	117	18	13	31	80	16	39	38	M14	UKFL206	UK206	FL206	
30	161	130	19	14	34	90	16	42,5	43	M14	UKFL207	UK207	FL207	
35	175	144	21	14	36	100	16	46,5	46	M14	UKFL208	UK208	FL208	
40	188	148	22	16	38	108	19	48,5	50	M16	UKFL209	UK209	FL209	
45	197	157	22	16	40	115	19	50	55	M16	UKFL210	UK210	FL210	
50	224	184	25	18	43	130	19	54,5	59	M16	UKFL211	UK211	FL211	
55	250	202	29	18	48	140	23	61	62	M20	UKFL212	UK212	FL212	
60	258	210	30	20	50	155	23	64	65	M20	UKFL213	UK213	FL213	

Note: Inch sizes available on request.

Medium duty two bolts flanged units cast housing set screws type

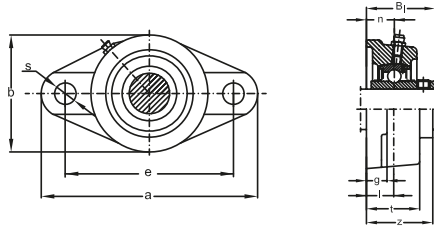

Shaft dia.	Nominal dimensions										Bolt size	Unit number	Bearing number	Housing number
	a	e	i	g	t	b	s	z	Bi	n				
mm														
25	141	117	18	13	30	83	12	40,2	38,1	15,9	M10	UCFLX05	UCX05	FLX05
30	156	130	19	15	34	95	16	44,4	42,9	17,5	M14	UCFLX06	UCX06	FLX06
35	171	144	22	16	38	105	16	51,2	49,2	19	M14	UCFLX07	UCX07	FLX07
40	179	148	22	16	40	111	16	52,2	49,2	19	M14	UCFLX08	UCX08	FLX08
45	189	157	23	16	40	116	16	55,6	51,6	19	M14	UCFLX09	UCX09	FLX09
50	216	184	26	18	44	133	19	59,4	55,6	22,2	M16	UCFLX10	UCX10	FLX10

Note: Inch sizes available on request.

Heavy duty two bolts flanged units cast housing set screws type

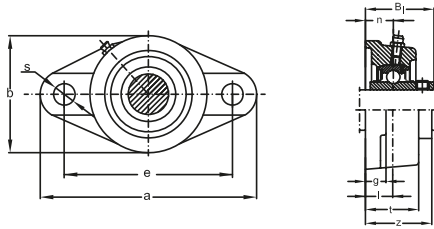

Shaft Nominal dia.	Dimensions										Bolt size	Unit number	Bearing number	Housing number	
	a	e	i	g	t	b	s	z	Bi	n					
mm															
25	150	113	16	13	29	80	19	39	38	15	M16	UCFL305	UC305	FL305	
30	180	134	18	15	32	90	23	44	43	17	M20	UCFL306	UC306	FL306	
35	185	141	20	16	36	100	23	49	48	19	M20	UCFL307	UC307	FL307	
40	200	158	23	17	40	112	23	56	52	19	M20	UCFL308	UC308	FL308	
45	230	177	25	18	44	125	25	60	57	22	M22	UCFL309	UC309	FL309	
50	240	187	28	19	48	140	25	67	61	22	M22	UCFL310	UC310	FL310	
55	250	198	30	20	52	150	25	71	66	25	M22	UCFL311	UC311	FL311	
60	270	212	33	22	56	160	31	78	71	26	M27	UCFL312	UC312	FL312	
65	295	240	33	25	58	175	31	78	75	30	M27	UCFL313	UC313	FL313	
70	315	250	36	28	61	185	35	81	78	33	M30	UCFL314	UC314	FL314	
75	320	260	39	30	66	195	35	89	82	32	M30	UCFL315	UC315	FL315	
80	355	285	38	32	68	210	38	90	86	34	M33	UCFL316	UC316	FL316	

Note: Inch sizes available on request.

Standard duty flanged cartridge units pressed steel housing set screws type

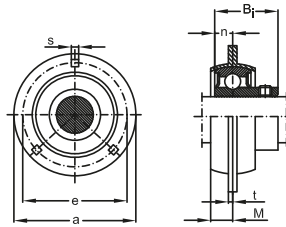

Shaft dia.	Nominal dimensions			s	M	Bi	n	Bolt size	Unit number	Bearing number	Housing number	
	a	e	t									
mm												
12	81	63,5	2	7,1	7	22	6	M6	SBPF203	SB201	PF201	
15	81	63,5	2	7,1	7	22	6	M6	SBPF203	SB202	PF202	
17	81	63,5	2	7,1	7	22	6	M6	SBPF203	SB203	PF203	
20	90	71,5	2	9	8	25	7	M8	SBPF204	SB204	PF204	
25	95	76	2	9	9	27	7,5	M8	SBPF205	SB205	PF205	
30	113	90,5	2,6	11	9,5	29	8	M10	SBPF206	SB206	PF206	
35	122	100	2,6	11	11	32	8,5	M10	SBPF207	SB207	PF207	

Note: Inch sizes available on request.

Standard duty flanged cartridge units cast housing set screws type

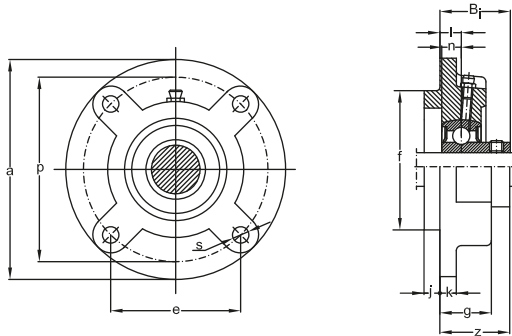

Shaft dia.	Nominal dimensions											Bolt size number	Unit number	Bearing number	Housing number	
	a	p	e	i	s	j	k	g	f	z	Bi					n
mm																
20	100	78	55,1	10	12	5	6	20,5	62	28	25	7	M10	SB204	SBFC204	FC204
25	115	90	63,6	10	12	6	7	21	70	29,5	27	7,5	M10	SB205	SBFC205	FC205
30	125	100	70,7	10	12	8	8	23	80	31	29	8	M10	SB206	SBFC206	FC206
35	135	110	77,8	11	14	9	9	26	90	34,5	32	8,5	M12	SB207	SBFC207	FC 207
40	145	120	84,8	11	14	9	9	26	100	35,5	34	9,5	M12	SB208	SBFC208	FC208

Note: Inch sizes available on request.

Standard duty flanged cartridge units cast housing set screws type

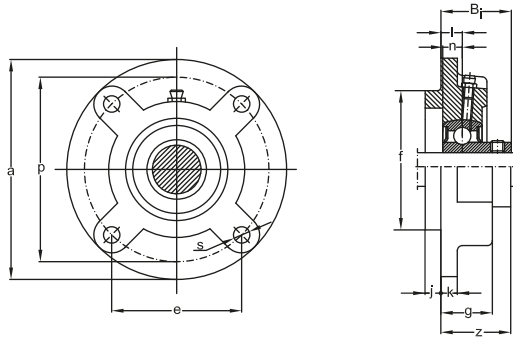

Shaft dia.	Nominal dimensions										Bolt size	Unit number	Bearing number	Housing number		
	a	p	e	i	s	j	k	g	f	z					Bi	n
mm	-															
12	100	78	55,1	10	12	5	6	20,5	62	28,3	31	12,7	M10	UCFC201	UC201	FC201
15	100	78	55,1	10	12	5	6	20,5	62	28,3	31	12,7	M10	UCFC202	UC202	FC202
17	100	78	55,1	10	12	5	6	20,5	62	28,3	31	12,7	M10	UCFC203	UC203	FC203
20	100	78	55,1	10	12	5	6	20,5	62	28,3	31	12,7	M10	UCFC204	UC204	FC204
25	115	90	63,6	10	12	6	7	21	70	29,7	34	14,3	M10	UCFC205	UC205	FC205
30	125	100	70,7	10	12	8	8	23	80	32,2	38,1	15,9	M10	UCFC206	UC206	FC206
35	135	110	77,8	11	14	8	9	26	90	36,4	42,9	17,5	M12	UCFC207	UC207	FC207
40	145	120	84,8	11	14	10	9	26	100	41,2	49,2	19	M12	UCFC208	UC208	FC208
45	160	132	93,3	10	16	12	10	26	105	40,2	49,2	19	M14	UCFC209	UC209	FC209
50	165	138	97,6	10	16	12	14	28	110	42,6	51,6	19	M14	UCFC210	UC210	FC210
55	185	150	106,1	13	19	12	13	30	125	46,4	55,6	22,2	M16	UCFC211	UC211	FC211
60	195	160	113,1	17	19	12	15	36	135	56,7	65,1	25,4	M16	UCFC212	UC212	FC212
65	205	170	120,2	16	19	14	15	35	145	55,7	65,1	25,4	M16	UCFC213	UC213	FC213
70	215	177	125,1	17	19	14	16	38	150	61,4	74,6	30,2	M16	UCFC214	UC214	FC214
75	220	184	130,1	18	19	16	17	39	160	62,5	77,8	33,3	M16	UCFC215	UC215	FC215
80	240	200	141,4	18	23	16	18	42	170	67,3	82,6	33,3	M20	UCFC216	UC216	FC216
85	250	208	147,1	18	23	18	20	45	180	69,6	85,7	34,1	M20	UCFC217	UC217	FC217
90	265	220	155,5	22	23	20	18	50	190	78,3	96	39,7	M20	UCFC218	UC218	FC218

Standard duty flanged cartridge units pressed steel housing set screws type

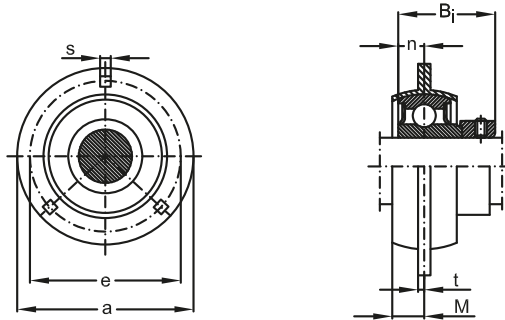

Shaft dia.	Nominal dimensions		t	s	M	Bi	n	Bolt size	Unit number	Bearing number	Housing number
	a	e									
mm											
12	81	63,5	2	7,1	7	28,5	6	M6	SAPF201	SA201	PF201
15	81	63,5	2	7,1	7	28,5	6	M6	SAPF202	SA202	PF202
17	81	63,5	2	7,1	7	28,5	6	M6	SAPF203	SA203	PF203
20	90	71,5	2	9	8	29,5	7	M8	SAPF204	SA204	PF204
25	95	76	2	9	9	30,5	7,5	M8	SAPF205	SA205	PF205
30	113	90,5	2,6	11	9,5	33,9	8	M10	SAPF206	SA206	PF206
35	122	100	2,6	11	11	37,5	8,5	M10	SAPF207	SA207	PF207

Note: Inch sizes available on request.

Standard duty flanged cartridge units cast housing eccentric locking collar type

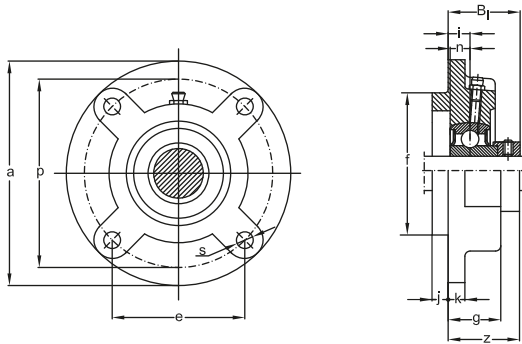

Shaft dia.	Nominal dimensions											Bolt size	Unit number	Bearing number	Housing number	
	a	p	e	i	s	j	k	g	f	z	Bi					n
mm													-			
20	100	78	55,1	10	12	5	6	20,5	62	32,5	29,5	7	M10	SAFC204	SA204	FC204
25	115	90	63,6	10	12	6	7	21	70	33	30,5	7,5	M10	SAFC205	SA205	FC205
30	125	100	70,7	10	12	8	8	23	80	35,9	33,9	8	M10	SAFC206	SA206	FC206
35	135	110	77,8	11	14	8	9	26	90	40	37,5	8,5	M12	SAFC207	SA207	FC207
40	145	120	84,8	11	14	10	9	26	100	42	40,5	9,5	M12	SAFC208	SA208	FC208
45	160	132	93,3	10	16	12	10	26	105	42,2	42,2	10	M14	SAFC209	SA209	FC209
50	165	138	97,6	10	16	12	14	28	110	43,2	43,7	10,5	M14	SAFC210	SA210	FC210
55	185	150	106,1	13	19	12	13	30	125	49,9	48,4	11,5	M16	SAFC211	SA211	FC211

Note: Inch sizes available on request.

Standard duty flanged cartridge units cast housing eccentric locking collar type

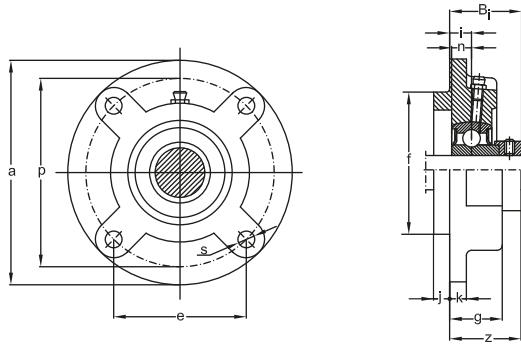

Shaft Nominal dia.	Dimensions														Bolt size	Unit number	Bearing number	Housing number
	a	p	e	i	s	j	k	g	f	z	Bi	n						
mm																		
12	100	78	55,1	10	12	5	6	20,5	62	36,5	43,5	17	M10	UELFC201	UEL201	FC201		
15	100	78	55,1	10	12	5	6	20,5	62	36,5	43,5	17	M10	UELFC202	UEL202	FC202		
17	100	78	55,1	10	12	5	6	20,5	62	36,5	43,5	17	M10	UELFC203	UEL203	FC203		
20	100	78	55,1	10	12	5	6	20,5	62	36,5	43,5	17	M10	UELFC204	UEL204	FC204		
25	115	90	63,6	10	12	6	7	21	70	36,9	44,3	17,4	M10	UELFC205	UEL205	FC205		
30	125	100	70,7	10	12	8	8	23	80	40,1	48,3	18,2	M10	UELFC206	UEL206	FC206		
35	135	110	77,8	11	14	8	9	26	90	43,3	51,1	18,8	M12	UELFC207	UEL207	FC207		
40	145	120	84,8	11	14	10	9	26	100	45,9	56,3	21,4	M12	UELFC208	UEL208	FC208		
45	160	132	93,3	10	16	12	10	26	105	44,9	56,3	21,4	M14	UELFC209	UEL209	FC209		
50	165	138	97,6	10	16	12	14	28	110	48,1	62,7	24,6	M14	UELFC210	UEL210	FC210		
55	185	150	106,1	13	19	12	13	30	125	56,6	71,3	27,7	M16	UELFC211	UEL211	FC211		
60	195	160	113,1	17	19	12	15	36	135	63,8	77,7	30,9	M16	UELFC212	UEL212	FC212		
65	205	170	120,2	16	19	14	15	35	145	67,6	85,7	34,1	M16	UELFC213	UEL213	FC213		
70	215	177	125,1	17	19	14	16	38	150	68,6	85,7	34,1	M16	UELFC214	UEL214	FC214		
75	220	184	130,1	18	19	16	17	39	160	72,8	92,1	37,3	M16	UELFC215	UEL215	FC215		

Note: Inch sizes available on request.

Standard duty flanged cartridge units cast housing adapter type

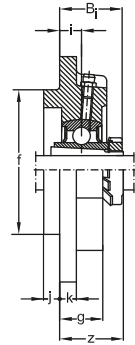
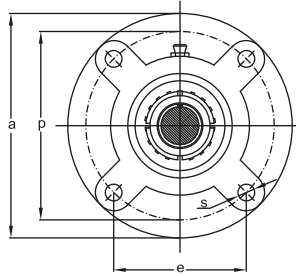

Shaft dia.	Nominal dimensions										Bolt size	Unit number	Bearing number	Housing number	
	a	p	e	i	s	j	k	g	f	z					Bi
mm															
20	115	90	63,6	10	12	6	7	21	70	29,5	35	M10	UKFC205	UK205	FC205
25	125	100	70,7	10	12	8	8	23	80	31	38	M10	UKFC206	UK206	FC206
30	135	110	77,8	11	14	8	9	26	90	34,5	43	M12	UKFC207	UK207	FC207
35	145	120	84,8	11	14	10	9	26	100	36,5	46	M12	UKFC208	UK208	FC208
40	160	132	93,3	10	16	12	10	26	105	36,5	50	M14	UKFC209	UK209	FC209
45	165	138	97,6	10	16	12	14	28	110	38	55	M14	UKFC210	UK210	FC210
50	185	150	106,1	13	19	12	13	30	125	42,5	59	M16	UKFC211	UK211	FC211
55	195	160	113,1	17	19	12	15	36	135	49	62	M16	UKFC212	UK212	FC212
60	205	170	120,2	16	19	14	15	35	145	50	65	M16	UKFC213	UK213	FC213

Note: Inch sizes available on request.

Standard duty hanger units set screws type

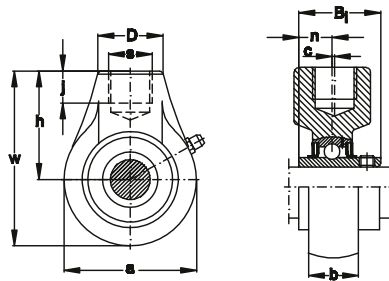

Shaft dia.	Nominal dimensions										Unit number	Bearing number	Housing number
	a	w	c	b	h	s	n	D	j	Bi			
mm													
12	64	96	0	22	64	RP 3/4	40	19	31	12,7	UCHA201	UC201	HA201
15	64	96	0	22	64	RP 3/4	40	19	31	12,7	UCHA202	UC202	HA202
17	64	96	0	22	64	RP 3/4	40	19	31	12,7	UCHA203	UC203	HA203
20	64	96	0	22	64	RP 3/4	40	19	31	12,7	UCHA204	UC204	HA204
25	78	103	0	23	64	RP 3/4	40	19	34	14,3	UCHA205	UC205	HA205
30	78	103	0	25	64	RP 3/4	40	19	38,1	15,9	UCHA206	UC206	HA206
35	92	116	0	26	70	RP 3/4	40	19	42,9	17,5	UCHA207	UC207	HA207
40	96	121	2	30	73	RP 3/4	40	19	49,2	19	UCHA208	UC208	HA208
45	108	136	5	30	82	RP 1	48	21	49,2	19	UCHA209	UC209	HA209
50	115	140,5	5	32	83	RP 1	48	21	51,6	19	UCHA210	UC210	HA210
55	126	150	7	33	87	RP 1-1/4	60	24	55,6	22,2	UCHA211	UC211	HA211
60	142	173	9	36	102	RP 1-1/4	60	28	65,1	25,4	UCHA212	UC212	HA212
65	166	200	9,5	38	117	RP 1-1/2	70	32	65,1	25,4	UCHA213	UC213	HA213
70	166	200	9,5	40	117	RP 1-1/2	70	32	74,6	30,2	UCHA214	UC214	HA214
75	166	200	9,5	40	117	RP 1-1/2	70	32	77,8	33,3	UCHA215	UC215	HA215

Note: Inch sizes available on request.

Standard duty hanger units set screws type

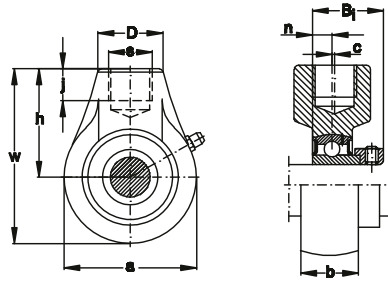

Shaft dia.	Nominal dimensions										Unit number	Bearing number	Housing number
	a	w	c	b	h	s	n	D	j	Bi			
mm													
20	64	96	0	22	64	RP 3/4	40	19	29,5	7	SAHA204	SA204	HA204
25	78	103	0	23	64	RP 3/4	40	19	30,5	7,5	SAHA205	SA205	HA205
30	78	103	0	25	64	RP 3/4	40	19	33,9	8	SAHA206	SA206	HA206
35	92	116	0	26	70	RP 3/4	40	19	37,5	8,5	SAHA207	SA207	HA207
40	96	121	2	30	73	RP 3/4	40	19	40,5	9,5	SAHA208	SA208	HA208
45	108	136	5	30	82	RP 1	48	21	42,2	10	SAHA209	SA209	HA209
50	115	140,5	5	32	83	RP 1	48	21	43,7	10,5	SAHA210	SA210	HA210
55	126	150	7	33	87	RP 1-1/4	60	24	48,4	11,5	SAHA211	SA211	HA211

Note: Inch sizes available on request.

Standard duty cylindrical cartridge units set screws type

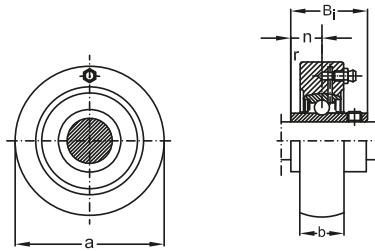

Shaft dia.	Nominal dimensions		r	Bi	n	Unit number	Bearing number	Housing number
	a	b						
mm								
12	72	20	2	31	12,7	UCC201	UC201	C204
15	72	20	2	31	12,7	UCC202	UC202	C204
17	72	20	2	31	12,7	UCC203	UC203	C204
20	72	20	2	31	12,7	UCC204	UC204	C204
25	80	22	2	34	14,3	UCC205	UC205	C205
30	85	27	2	38,1	15,9	UCC206	UC206	C206
35	90	28	2	42,9	17,5	UCC207	UC207	C207
40	100	30	2,5	49,2	19	UCC208	UC208	C208
45	110	31	2,5	49,2	19	UCC209	UC209	C209
50	120	33	2,5	51,6	19	UCC210	UC210	C210
55	125	35	2,5	55,6	22,2	UCC211	UC211	C211
60	130	38	2,5	65,1	25,4	UCC212	UC212	C212
65	140	40	3	65,1	25,4	UCC213	UC213	C213

Note: Inch sizes available on request.

Standard duty cylindrical cartridge units eccentric locking collar type

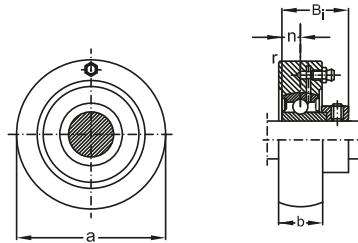

Shaft dia.	Nominal dimensions		r	Bi	n	Unit number	Bearing number	Housing number
	a	b						
mm						-		
20	72	20	2	7	29,5	SAC204	SA204	C204
25	80	22	2	7,5	30,5	SAC205	SA205	C205
30	85	27	2	8	33,9	SAC206	SA206	C206
35	90	28	2	8,5	37,5	SAC207	SA207	C207
40	100	30	2,5	9,5	40,5	SAC208	SA208	C208
45	110	31	2,5	10	42,2	SAC209	SA209	C209
50	120	33	2,5	10,5	43,7	SAC210	SA210	C210
55	125	35	2,5	11,5	48,4	SAC211	SA211	C211

Note: Inch sizes available on request.

Standard duty cylindrical cartridge units adapter type

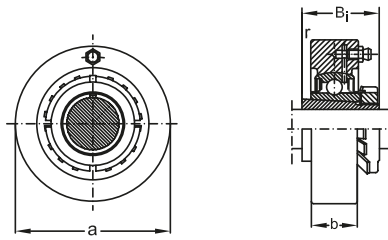

Shaft nominal dia.	Dimensions		r	Bi	Unit number	Bearing number	Housing number
	a	b					
mm					-		
20	80	22	2	35	UKC205	UK205	C205
25	85	27	2	38	UKC206	UK206	C206
30	90	28	2	43	UKC207	UK207	C207
35	100	30	2,5	46	UKC208	UK208	C208
40	110	31	2,5	50	UKC209	UK209	C209
45	120	33	2,5	55	UKC210	UK210	C210
50	125	35	2,5	59	UKC211	UK211	C211
55	130	38	2,5	62	UKC212	UK212	C212
60	140	40	3	65	UKC213	UK213	C213

Standard duty take-up units cast housing set screws type

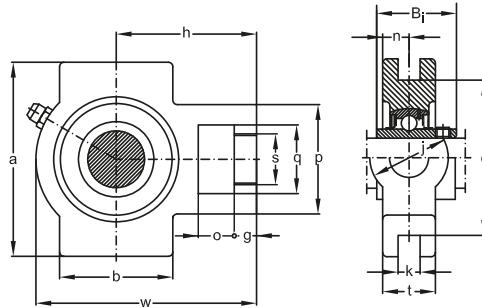

Shaft dia.	Nominal dimensions												Unit number	Bearing number	Housing number			
	o	g	p	q	s	b	k	e	a	w	j	t				h	Bi	n
mm																-		
20	16	10	51	32	19	51	13,5	76	89	94	32	21	61	31	12,7	UCST204	UC204	ST204
25	16	10	51	32	19	51	13,5	76	89	97	32	24	62	34	14,3	UCST205	UC205	ST205
30	16	10	56	37	22	57	13,5	89	102	113	37	28	70	38,1	15,9	UCST206	UC206	ST206
35	16	13	64	37	22	64	13,5	89	102	129	37	30	78	42,9	17,5	UCST207	UC207	ST207
40	19	16	83	49	29	83	17,5	101	114	144	49	33	88	49,2	19	UCST208	UC208	ST208
45	19	16	83	49	29	83	17,5	101	117	144	49	35	87	49,2	19	UCST209	UC209	ST209
50	19	16	83	49	29	86	17,5	101	117	149	49	37	90	51,6	19	UCST210	UC210	ST210
55	25	19	102	64	35	95	27	130	146	171	64	38	106	55,6	22,2	UCST211	UC211	ST211
60	32	19	102	64	35	102	27	130	146	194	64	42	119	65,1	25,4	UCST212	UC212	ST212
65	32	21	111	70	41	121	27	151	167	224	70	44	137	65,1	25,4	UCST213	UC213	ST213
70	32	21	111	70	41	121	27	151	167	224	70	46	137	74,6	30,2	UCST214	UC214	ST214
75	32	21	111	70	41	121	27	151	167	232	70	48	140	77,8	33,3	UCST215	UC215	ST215

Note: Inch sizes available on request.

Standard duty take-up units cast housing set screws type

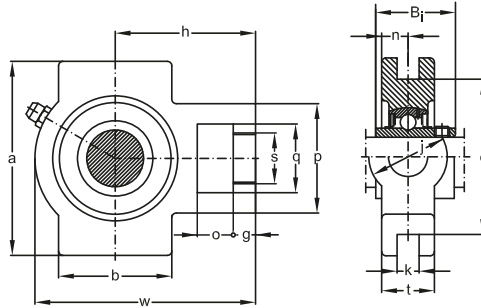

Shaft dia.	Nominal dimensions												Unit number	Bearing number	Housing number			
	o	g	p	q	s	b	k	e	a	w	j	t				h	Bi	n
mm																-		
12	16	10	51	32	19	51	12	76	89	94	32	21	61	31	12,7	UCT201	UC201	T204
15	16	10	51	32	19	51	12	76	89	94	32	21	61	31	12,7	UCT202	UC202	T204
17	16	10	51	32	19	51	12	76	89	94	32	21	61	31	12,7	UCT203	UC203	T204
20	16	10	51	32	19	51	12	76	89	94	32	21	61	31	12,7	UCT204	UC204	T204
25	16	10	51	32	19	51	12	76	89	97	32	24	62	34	14,3	UCT205	UC205	T205
30	16	10	56	37	22	57	12	89	102	113	37	28	70	38,1	15,9	UCT206	UC206	T206
35	16	13	64	37	22	64	12	89	102	129	37	30	78	42,9	17,5	UCT207	UC207	T207
40	19	16	83	49	29	83	16	102	114	144	49	33	88	49,2	19	UCT208	UC208	T208
45	19	16	83	49	29	83	16	102	117	144	49	35	87	49,2	19	UCT209	UC209	T209
50	19	16	83	49	29	86	16	102	117	149	49	37	90	51,6	19	UCT210	UC210	T210
55	25	19	102	64	35	95	22	130	146	171	64	38	106	55,6	22,2	UCT211	UC211	T211
60	32	19	102	64	35	102	22	130	146	194	64	42	119	65,1	25,4	UCT212	UC212	T212
65	32	21	111	70	41	121	26	151	167	224	70	44	137	65,1	25,4	UCT213	UC213	T213
70	32	21	111	70	41	121	26	151	167	224	70	46	137	74,6	30,2	UCT214	UC214	T214
75	32	21	111	70	41	121	26	151	167	232	70	48	140	77,8	33,3	UCT215	UC215	T215
80	32	21	111	70	41	121	26	165	184	235	70	51	140	82,6	33,3	UCT216	UC216	T216
85	38	29	124	73	48	157	30	173	198	260	73	54	162	85,7	34,1	UCT217	UC217	T217

Note: Inch sizes available on request.

Standard duty take-up units cast housing eccentric locking collar type

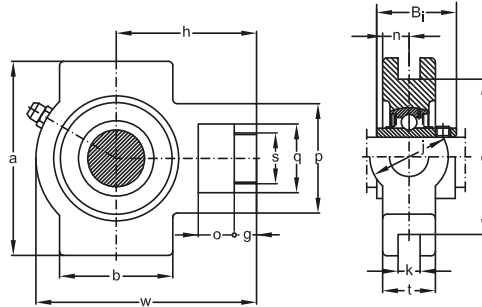

Shaft dia.	Nominal dimensions												Unit number	Bearing number	Housing number			
	o	g	p	q	s	b	k	e	a	w	j	t				h	Bi	n
mm																-		
20	16	10	51	32	19	51	13,5	76	89	94	32	21	61	29,5	7	SAST204	SA204	ST204
25	16	10	51	32	19	51	13,5	76	89	97	32	24	62	30,5	7,5	SAST205	SA205	ST205
30	16	10	56	37	22	57	13,5	89	102	113	37	28	70	33,9	8	SAST206	SA206	ST206
35	16	13	64	37	22	64	13,5	89	102	129	37	30	78	37,5	8,5	SAST207	SA207	ST207
40	19	16	83	49	29	83	17,5	101	114	144	49	33	88	40,5	9,5	SAST208	SA208	ST208
45	19	16	83	49	29	83	17,5	101	117	144	49	35	87	42,2	10	SAST209	SA209	ST209
50	19	16	83	49	29	86	17,5	101	117	149	49	37	90	43,7	10,5	SAST210	SA210	ST210
55	25	19	102	64	35	95	27	130	146	171	64	38	106	48,4	11,5	SAST211	SA211	ST211

Note: Inch sizes available on request.

Standard duty take-up units cast housing eccentric locking collar type

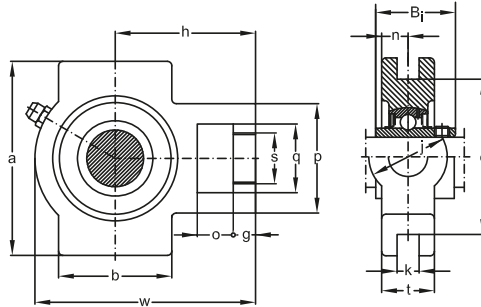

Shaft dia.	Nominal dimensions														Unit number	Bearing number	Housing number		
	o	g	p	q	s	b	k	e	a	w	j	t	h	Bi				n	
mm																	-		
20	16	10	51	32	19	51	12	76	89	94	32	21	61	29,5	7	SAT204	SA204	T204	
25	16	10	51	32	19	51	12	76	89	97	32	24	62	30,5	7,5	SAT205	SA205	T205	
30	16	10	56	37	22	57	12	89	102	113	37	28	70	33,9	8	SAT206	SA206	T206	
35	16	13	64	37	22	64	12	89	102	129	37	30	78	37,5	8,5	SAT207	SA207	T207	
40	19	16	83	49	29	83	16	102	114	144	49	33	88	40,5	9,5	SAT208	SA208	T208	
45	19	16	83	49	29	83	16	102	117	144	49	35	87	42,2	10	SAT209	SA209	T209	
50	19	16	83	49	29	86	16	102	117	149	49	37	90	43,7	10,5	SAT210	SA210	T210	
55	25	19	102	64	35	95	22	130	146	171	64	38	106	48,4	11,5	SAT211	SA211	T211	

Note: Inch sizes available on request.

Standard duty take-up units cast housing eccentric locking collar type

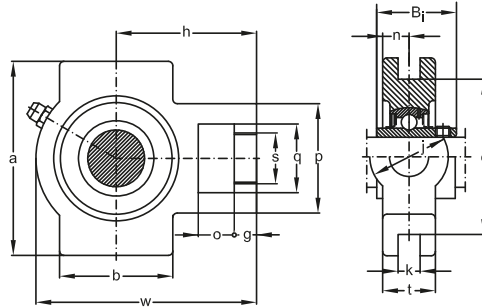

Shaft dia.	Nominal dimensions											Unit number	Bearing number	Housing number				
	o	g	p	q	s	b	k	e	a	w	j				t	h	Bi	n
mm																		
20	16	10	51	32	19	51	13,5	76	89	94	32	21	61	43,5	17	UELST204	UEL204	ST204
25	16	10	51	32	19	51	13,5	76	89	97	32	24	62	44,3	17,4	UELST205	UEL205	ST205
30	16	10	56	37	22	57	13,5	89	102	113	37	28	70	48,3	18,2	UELST206	UEL206	ST206
35	16	13	64	37	22	64	13,5	89	102	129	37	30	78	51,1	18,8	UELST207	UEL207	ST207
40	19	16	83	49	29	83	17,5	101	114	144	49	33	88	56,3	21,4	UELST208	UEL208	ST208
45	19	16	83	49	29	83	17,5	101	117	144	49	35	87	56,3	21,4	UELST209	UEL209	ST209
50	19	16	83	49	29	86	17,5	101	117	149	49	37	90	62,7	24,6	UELST210	UEL210	ST210
55	25	19	102	64	35	95	27	130	146	171	64	38	106	71,3	27,7	UELST211	UEL211	ST211
60	32	19	102	64	35	102	27	130	146	194	64	42	119	77,7	30,9	UELST212	UEL212	ST212
65	32	21	111	70	41	121	27	151	167	224	70	44	137	85,7	34,1	UELST213	UEL213	ST213
70	32	21	111	70	41	121	27	151	167	224	70	46	137	85,7	34,1	UELST214	UEL214	ST214
75	32	21	111	70	41	121	27	151	167	232	70	48	140	92,1	37,3	UELST215	UEL215	ST215

Note: Inch sizes available on request.

Standard duty take-up units cast housing eccentric locking collar type

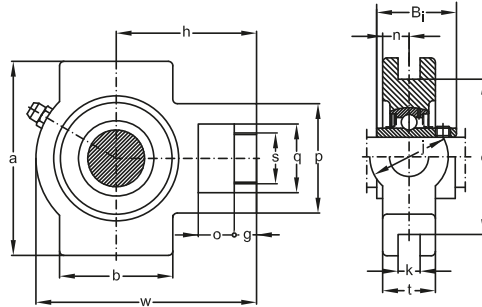

Shaft dia.	Nominal dimensions													Unit number	Bearing number	Housing number	
	o	g	p	q	s	b	k	e	a	w	j	t	h				Bi
mm														-			
12	16	12	51	32	19	51	12	76	89	94	32	21	61	43,5	17	UEL201	UEL201 T204
15	16	12	51	32	19	51	12	76	89	94	32	21	61	43,5	17	UEL202	UEL202 T204
17	16	12	51	32	19	51	12	76	89	94	32	21	61	43,5	17	UEL203	UEL203 T204
20	16	12	51	32	19	51	12	76	89	94	32	21	61	43,5	17	UEL204	UEL204 T204
25	16	12	51	32	19	51	12	76	89	97	32	24	62	44,3	17,4	UEL205	UEL205 T205
30	16	12	56	37	22	57	12	89	102	113	37	28	70	48,3	18,2	UEL206	UEL206 T206
35	16	15	64	37	22	64	12	89	102	129	37	30	78	51,1	18,8	UEL207	UEL207 T207
40	19	18	83	49	29	83	16	102	114	144	49	33	88	56,3	21,4	UEL208	UEL208 T208
45	19	18	83	49	29	83	16	102	117	144	49	35	87	56,3	21,4	UEL209	UEL209 T209
50	19	18	83	49	29	86	16	102	117	149	49	37	90	62,7	24,6	UEL210	UEL210 T210
55	25	21	102	64	35	95	22	130	146	171	64	38	106	71,3	27,7	UEL211	UEL211 T211
60	32	21	102	64	35	102	22	130	146	194	64	42	119	77,7	30,9	UEL212	UEL212 T212
65	32	23	111	70	41	121	26	151	167	224	70	44	137	85,7	34,1	UEL213	UEL213 T213
70	32	23	111	70	41	121	26	151	167	224	70	46	137	85,7	34,1	UEL214	UEL214 T214
75	32	23	111	70	41	121	26	151	167	232	70	48	140	92,1	37,3	UEL215	UEL215 T215

Note: Inch sizes available on request.

Standard duty take-up units cast housing adapter type

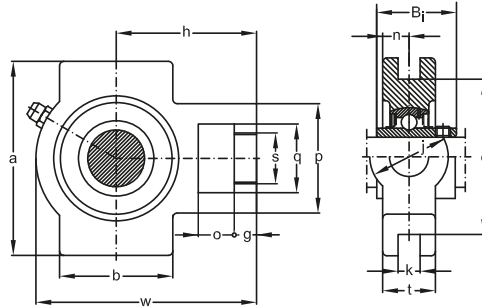

Shaft dia.	Nominal dimensions													Unit number	Bearing number	Housing number		
	o	g	p	q	s	b	k	e	a	w	j	t	h				Bi	
mm																-		
20	16	12	51	32	19	51	12	76	89	97	32	24	62	35	UKT205	UK205	T205	
25	16	12	56	37	22	57	12	89	102	113	37	28	70	38	UKT206	UK206	T206	
30	16	15	64	37	22	64	12	89	102	129	37	30	78	43	UKT207	UK207	T207	
35	19	18	83	49	29	83	16	102	114	144	49	33	88	46	UKT208	UK208	T208	
40	19	18	83	49	29	83	16	102	117	144	49	35	87	50	UKT209	UK209	T209	
45	19	18	83	49	29	86	16	102	117	149	49	37	90	55	UKT210	UK210	T210	
50	25	21	102	64	35	95	22	130	146	171	64	38	106	59	UKT211	UK211	T211	
55	32	21	102	64	35	102	22	130	146	194	64	42	119	62	UKT212	UK212	T212	
60	32	23	111	70	41	121	26	151	167	224	70	44	137	65	UKT213	UK213	T213	

Standard duty spherical outside surface ball bearings set screws type

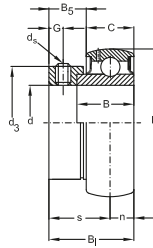

Shaft dia. d	Nominal dimensions			n	s	G	d _s	Bearing number	Basic load ratings	
	D	B _i	C						dyn. C _r	stat. C _{0r}
mm								-	N	
12	40	22	12	6	16	4	M5X0,8	SB201	9,6	4,6
15	40	22	12	6	16	4	M5X0,8	SB202	9,6	4,6
17	40	22	12	6	16	4	M5X0,8	SB203	9,6	4,6
20	47	25	14	7	18	5	M6X1	SB204	12,8	6,65
25	52	27	15	7,5	19,5	5,5	M6X1	SB205	14	7,85
30	62	29	16	8	21	6	M6X1	SB206	19,5	11,3
35	72	32	17	8,5	23,5	6,5	M6X1	SB207	25,7	15,3
40	80	34	19	9,5	24,5	7	M8X1	SB208	29,1	17,8

Note: Inch sizes available on request.

Standard duty spherical outside surface ball bearings set screws type

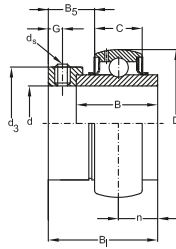

Shaft dia. d	Nominal dimensions			n	s	G	F	d _s	Bearing number	Basic load ratings	
	D	B _i	C							dyn. C _r	stat. C _{or}
mm									-	N	
12	47	31	16	12,7	18,3	5	3,5	M5X0,8	UC201	12,8	6,65
15	47	31	16	12,7	18,3	5	3,5	M5X0,8	UC202	12,8	6,65
17	47	31	16	12,7	18,3	5	3,5	M5X0,8	UC203	12,8	6,65
20	47	31	16	12,7	18,3	5	3,5	M6X1	UC204	12,8	6,65
25	52	34	17	14,3	19,7	5,5	4	M6X1	UC205	14	7,85
30	62	38,1	19	15,9	22,2	6	4,2	M6X1	UC206	19,5	11,3
35	72	42,9	20	17,5	25,4	6,5	4,3	M8X1	UC207	25,7	15,3
40	80	49,2	21	19	30,2	8	4,2	M8X1	UC208	29,1	17,8
45	85	49,2	22	19	30,2	8	4,2	M8X1	UC209	32,5	20,4
50	90	51,6	23	19	32,6	9	4,8	M10X1,25	UC210	35	23,2
55	100	55,6	25	22,2	33,4	9	5,3	M10X1,25	UC211	43,5	29,2
60	110	65,1	27	25,4	39,7	10,5	5,3	M10X1,25	UC212	52,5	36
65	120	65,1	28	25,4	39,7	12	6	M12X1,25	UC213	57,5	40
70	125	74,6	30	30,2	44,4	12	6	M12X1,25	UC214	62	44
75	130	77,8	30	33,3	44,5	12	6	M12X1,25	UC215	66	49,5
80	140	82,6	33	33,3	49,3	14	6,3	M12X1,25	UC216	72,5	53
85	150	85,7	35	34,1	51,6	14	6,5	M12X1,25	UC217	83,5	64
90	160	96	37	39,7	56,3	14	6,5	M12X1,25	UC218	96	71,5

Note: Inch sizes available on request.

Standard duty spherical outside surface ball bearings eccentric locking collar type

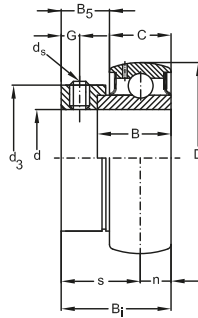

Shaft		Nominal dimensions									Bearing number	Basic load ratings	
d	D	B _i	B	C	n	s	G	d _s	d ₃	B ₅		dyn C _r	stat. C _{0r}
mm											-	N	
12	40	28,5	19	12	6	22,5	4,8	M6X1	28,6	13,5	SA201	9,6	4,6
15	40	28,5	19	12	6	22,5	4,8	M6X1	28,6	13,5	SA202	9,6	4,6
17	40	28,5	19	12	6	22,5	4,8	M6X1	28,6	13,5	SA203	9,6	4,6
20	47	29,5	20	14	7	22,5	4,8	M6X1	33,3	13,5	SA204	12,8	6,65
25	52	30,5	21	15	7,5	23	4,8	M6X1	38,1	13,5	SA205	14	7,85
30	62	33,9	22	16	8	25,9	6	M6X1	44,5	15,9	SA206	19,5	11,3
35	72	37,5	24	17	8,5	29	6,8	M8X1	55,6	17,5	SA207	25,7	15,3
40	80	40,5	27	19	9,5	31	6,8	M8X1	60,3	18,3	SA208	29,1	17,8
45	85	42,2	28,7	20	10	32,2	6,8	M8X1	63,5	18,3	SA209	32,5	20,4
50	90	43,7	30,2	21	10,5	33,2	6,8	M8X1	69,9	18,3	SA210	35	23,2
55	100	48,8	32,4	23	11,5	36,9	8	M10X1,25	76,2	18,3	SA211	43,5	29,2

Note: Inch sizes available on request.

Standard duty spherical outside surface ball bearings eccentric locking collar type

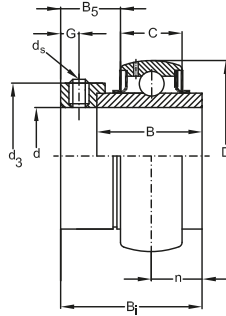

Shaft		Nominal dimensions										Bearing number	Basic load ratings	
d	D	B _i	C	n	B	G	d ₃	B ₅	F	d _s	dyn C _r		stat. C _{0r}	
mm												-	N	
12	47	43,5	16	17	34	4,8	33,3	13,5	3,5	M6X1	UEL201	12,8	6,65	
15	47	43,5	16	17	34	4,8	33,3	13,5	3,5	M6X1	UEL202	12,8	6,65	
17	47	43,5	16	17	34	4,8	33,3	13,5	3,5	M6X1	UEL203	12,8	6,65	
20	47	43,5	16	17	34	4,8	33,3	13,5	3,5	M6X1	UEL204	12,8	6,65	
25	52	44,3	17	17,4	34,8	4,8	38,1	13,5	4	M6X1	UEL205	14	7,85	
30	62	48,3	19	18,2	36,4	6	44,5	15,9	4,2	M8X1	UEL206	19,5	11,3	
35	72	51,1	20	18,8	37,6	6,8	55,6	17,5	4,3	M8X1	UEL207	25,7	15,3	
40	80	56,3	21	21,4	42,8	6,8	60,3	18,3	4,2	M8X1	UEL208	29,1	17,8	
45	85	56,3	22	21,4	42,8	6,8	63,5	18,3	4,2	M8X1	UEL209	32,5	20,4	
50	90	62,7	23	24,6	49,2	6,8	69,9	18,3	4,8	M8X1	UEL210	35	23,2	
55	100	71,3	25	27,7	55,4	8	76,2	20,7	5,3	M10X1,25	UEL211	43,5	29,2	
60	110	77,7	27	30,9	61,8	8	84	22,3	5,3	M10X1,25	UEL212	52,5	36	
65	120	85,7	28	34,1	68,2	8,7	86	23,5	6	M10X1,25	UEL213	57,5	40	
70	125	85,7	30	34,1	68,2	8,7	96	23,9	6	M10X1,25	UEL214	62	44	
75	130	92,1	30	37,3	74,6	8,7	102	23,9	6	M10X1,25	UEL215	66	49,5	

Note: Inch sizes available on request.

Standard duty spherical outside surface ball bearings adapter type

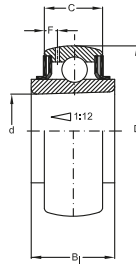

Shaft dia. d	Nominal dimensions			F	Bearing number	Basic load ratings	
	D	B ₁	C			dyn C _r	stat. C _{0r}
mm					-	N	
20	52	21	17	4,2	UK205	14	7,85
25	62	25	19	4,5	UK206	19,5	11,3
30	72	27	20	4,2	UK207	25,7	15,3
35	80	29	21	4,2	UK208	29,1	17,8
40	85	30	22	4,2	UK209	32,5	20,4
45	90	31	23	5	UK210	35	23,2
50	100	33	27	6,3	UK211	43,5	29,2
55	110	36	27	5,3	UK212	52,5	36
60	120	36	28	6	UK213	57,5	40

Medium duty spherical outside surface ball bearings set screws type

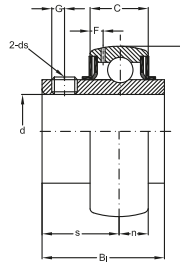

Shaft dia.	Nominal dimensions									Bearing number	Basic load ratings	
	d	D	B _i	C	n	s	G	F	d _s		dyn C _r	stat. C _{0r}
mm										-	N	
25	62	38,1	19	15,9	22,2	6	5	M6X1	UCX05	19,5	11,3	
30	72	42,9	22	17,5	25,4	6,5	5,8	M8X1	UCX06	25,7	15,3	
35	80	49,2	21	19	30,2	8	6,3	M8X1	UCX07	29,1	17,8	
40	85	49,2	22	19	30,2	8	6,8	M8X1	UCX08	32,5	20,4	
45	90	51,6	23	19	32,6	9	6,5	M10X1,25	UCX09	35	23,2	
50	100	55,6	25	22,2	33,4	9	7,2	M10X1,25	UCX10	43,5	29,2	
55	110	65,1	27	25,4	39,7	10,5	8,2	M10X1,25	UCX11	52,5	36	
60	120	65,1	28	25,4	39,7	12	8	M12X1,25	UCX12	57,5	40	
65	125	74,6	30	30,2	44,4	12	9	M12X1,25	UCX13	62	44	
70	130	77,8	30	33,3	44,5	12	9	M12X1,25	UCX14	66	49,5	
75	140	82,6	33	33,3	49,3	14	10,3	M12X1,25	UCX15	72,5	53	
80	150	85,7	35	34,1	51,6	14	11	M12X1,25	UCX16	83,2	63,8	

Heavy duty spherical outside surface ball bearings set screws type

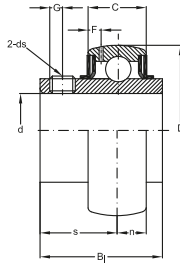

Shaft dia. d	Nominal dimensions			n	s	G	F	d _s	Bearing number	Basic load ratings	
	D	B _i	C							dyn C _r	stat. C _{0r}
mm									-	N	
25	62	38	21	15	23	6	4,3	M6X1	UC305	21,2	10,9
30	72	43	24	17	26	6	5,5	M6X1	UC306	26,7	15
35	80	48	25	19	29	8	5,3	M8X1	UC307	33,5	19,1
40	90	52	28	19	33	10	5,5	M10X1,25	UC308	40,5	24
45	100	57	30	22	35	10	6	M10X1,25	UC309	53	32
50	110	61	32	22	39	12	6,1	M12X1,25	UC310	62	38,5
55	120	66	34	25	41	12	6,4	M12X1,25	UC311	71,5	45
60	130	71	36	26	45	12	6,7	M12X1,25	UC312	82	52
65	140	75	38	30	45	12	6,9	M12X1,25	UC313	92,5	60
70	150	78	40	33	47	12	7,2	M12X1,25	UC314	104	68
75	160	82	42	32	50	14	7,5	M14X1,5	UC315	113	77
80	170	86	44	34	52	14	7,5	M14X1,5	UC316	122	86

SSUCP series pillow blocks

Normal duty with set screw lock and grease fitting

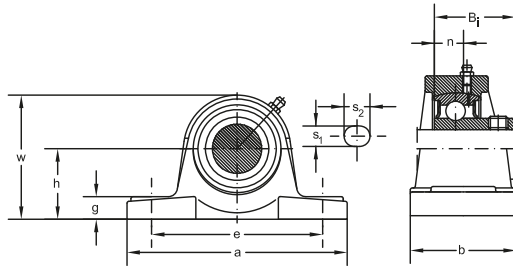

Dimensions

Unit no. **Bolt size** **Bearing no.** **Housing no.**

d	B	n	b	h	g	w	a	e	s ₁	s ₂	Unit no.	Bolt size	Bearing no.	Housing no.	
mm											-	mm			
12	27,4	11,5	38	30,2	14	62	127	95	12	19	SSUCP201	M10	SSUC201	SSP203	
15	27,4	11,5	38	30,2	14	62	127	95	12	19	SSUCP202	M10	SSUC202	SSP203	
17	27,4	11,5	38	30,2	14	62	127	95	12	19	SSUCP203	M10	SSUC203	SSP203	
20	31	12,7	38	33,3	15	65	127	95	12	19	SSUCP204	M10	SSUC204	SSP204	
25	34,1	14,3	38	36,5	16	70	140	105	15	19	SSUCP205	M10	SSUC205	SSP205	
30	38,1	15,9	48	42,9	18	83	165	121	15	21	SSUCP206	M12	SSUC206	SSP206	
35	42,9	17,5	48	47,6	19	94	167	127	15	21	SSUCP207	M12	SSUC207	SSP207	
40	49,2	19	54	49,2	19	100	184	137	15	23	SSUCP208	M12	SSUC208	SSP208	
45	49,2	19	54	54	20	108	190	146	15	23	SSUCP209	M12	SSUC209	SSP209	
50	51,6	19	60	57,2	22	114	206	159	19	23	SSUCP210	M16	SSUC210	SSP210	

Note: Grease fitting 1/4 - 28 UNF

SSUCF series four bolt flanges

Normal duty with set screw lock and grease fitting

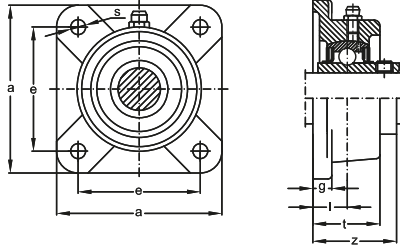

Dimensions

Unit no. Bolt size Bearing no. Housing no.

d	z	t	g	i	s	a	e	Unit no.	Bolt size	Bearing no.	Housing no.	
mm								-	mm			
12	30,9	24	11	15	12	76	54	SSUCF201	M10	SSUC201	SSF203	
15	30,9	24	11	15	12	76	54	SSUCF202	M10	SSUC202	SSF203	
17	20,9	24	11	15	12	76	54	SSUCF203	M10	SSUC203	SSF203	
20	33,3	25	11	15	12	86	63,5	SSUCF204	M10	SSUC204	SSF204	
25	35,8	26,5	13	16	12	95	70	SSUCF205	M10	SSUC205	SSF205	
30	40,2	30	13	18	15	108	82,5	SSUCF206	M12	SSUC206	SSF206	
35	44,4	33	14	19	15	117	92	SSUCF207	M12	SSUC207	SSF207	
40	51,2	36	14	21	15	130	101,5	SSUCF208	M12	SSUC208	SSF208	
45	52,2	38	14	22	15	137	105	SSUCF209	M12	SSUC209	SSF209	
50	54,6	39	15	22	19	143	111	SSUCF210	M16	SSUC210	SSF210	

SSUCFL series two bolt flanges

Normal duty with set screw lock and grease fitting

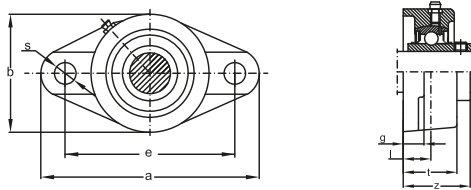

Dimensions

Unit no. Bolt size Bearing no. Housing no.

d	z	t	g	i	b	s	a	e	Unit no.	Bolt size	Bearing no.	Housing no.
mm									-	mm		
12	30,9	24	11	15	55	12	98,5	76,5	SSUCFL201	M10	SSUC201	SSFL203
15	30,9	24	11	15	55	12	98,5	76,5	SSUCFL202	M10	SSUC202	SSFL203
17	30,9	24	11	15	55	12	98,5	76,5	SSUCFL203	M10	SSUC203	SSFL203
20	33,3	25	11	15	60	12	112	90	SSUCFL204	M10	SSUC204	SSFL204
25	35,8	26,5	13	16	68	12	124	99	SSUCFL205	M10	SSUC205	SSFL205
30	40,2	30	13	18	80	15	141	116,5	SSUCFL206	M12	SSUC206	SSFL206
35	44,4	33	14	19	90	15	155,5	130	SSUCFL207	M12	SSUC207	SSFL207
40	51,2	36	14	21	100	15	171,5	143,5	SSUCFL208	M12	SSUC208	SSFL208
45	52,2	38	14	22	108	15	179	148,5	SSUCFL209	M12	SSUC209	SSFL209
50	54,6	39	15	22	115	19	189	157	SSUCFL210	M16	SSUC210	SSFL210

Note: Grease fitting 1/4 - 28 UNF

SSUC series bearing insert Normal duty with set screw lock

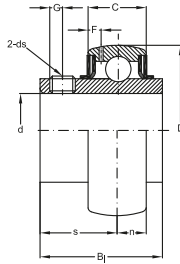

Dimensions							Basic load ratings			Designation
d	D	B	S	r _{min}	C	d _s	G	C _r *	C _{0r}	
H7	H5									
mm								N		
12	40	27,4	11,5	0,6	14	M5 x 0,5	4	7350	4750	SSUC201
15	40	27,4	11,5	0,6	14	M5 x 0,5	4	7350	4750	SSUC202
17	40	27,4	11,5	0,6	14	M5 x 0,5	4	7350	4750	SSUC203
20	47	31	12,7	1	17	M6 x 0,75	5	9800	6550	SSUC204
25	52	34,1	14,3	1	17	M6 x 0,75	5	10800	7800	SSUC205
30	62	38,1	15,9	1	19	M6 x 0,75	5	15000	11200	SSUC206
35	72	42,9	17,5	1,1	20	M8 x 1	7	19600	15300	SSUC207
40	80	49,2	19	1,1	21	M8 x 1	8	23600	19000	SSUC208
45	85	49,2	19	1,1	22	M8 x 1	8	25500	21600	SSUC209
50	90	51,6	19	1,1	24	M10 x 1	10	27000	23200	SSUC210

Note: *Multiply the load "Cr" by 1,3 if the tolerance of mounted shaft is "h6" or higher.

Cam Rollers

Standards, Boundary dimensions

Standard plans DIN 616

General

Cam Rollers are non - separable radial bearings. They are special variants of either radial **deep groove bearings** or **double row angular contact ball bearings**.

Cam roller run either directly on a guide track or against a surface that has been machined for a guidance.

To achieve this cam rollers feature an extra thick - walled outer ring this enables cam roller to accept high radial forces, including shock loads.

As cam rollers often run misaligned they are generally used with crowned outer ring surfaces.

Cam rollers normally run outside the machine compartment, under extreme operating conditions, in the presence of heavy contaminations (i.e. dust and dirt, etc).

For this reason, cam rollers are produced and fitted with contacting seals.

Some types of the Double Row cam rollers are also available with shields.

Design variants

(see also drawings on following pages)

Cam rollers are readily available in several design variants. For the most common designs see drawings on page 713.

Single Row Cam Rollers

Cam rollers of the narrow series (series **3612..** and **3612.. R**, are based on the proven sealed single row deep groove ball bearings, (suffix **.2RS**) for their internal design.

The **ART cam rollers**, series **3612..** and **3612..R**, respectively, are produced with **.2RS** - type contacting seals as standard. These seals provide a very effective and efficient sealing of the bearing compartment against penetration by foreign particles even under unfavourable operating conditions.

The narrow **ART cam rollers**, series **3612** are available with either cylindrical (without extra suffix) or crowned outer ring diameter (suffix **R**) as standard.

The radius of crowning on single row cam rollers for the series **3612.. R**, is standardised at **R = 400 mm, irrespective of their outer diameter**.

Double Row Cam Rollers

The internal design of **ART double row cam rollers** (series **305** and **306**) are based on the double row angular contact ball bearings of the series **32..** (for series **305**) or **33..** (for series **306** cam rollers), respectively.

ART double row cam rollers have contact angles of 25° they also feature polyamide cages as standard.

Double row cam rollers are widely used with pressed steel shields, (suffix **.2Z**), they are also available with **rubbing seals** (suffix **.2RS**) as standard.

As for single row rollers, **ART double row cam rollers** are produced with either a, cylindrical or sphered outer ring diameters.

The radius of crowning of double row cam roller outer diameter is also **standardised at R = 400 mm**.

Material of seals

For the contacting seal of sealed **ART - cam**

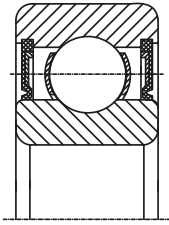

3612...

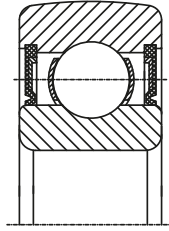

3612...R

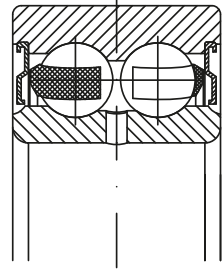

3057...2Z
3067...2Z

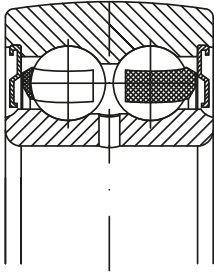

3058...2Z
3068...2Z

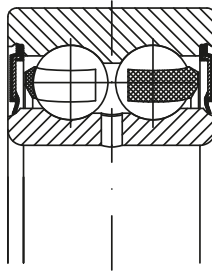

3057...2RS
3067...2RS

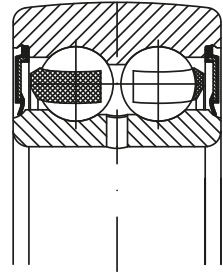

3058...2RS
3068...2RS

rollers (suffix **.2RS**) a wear - resistant **synthetic rubber (NBR)** is used as standard material.

This seal material is suitable for operating temperatures of **-30°C** up to **+120°C**.

On request, the **ART** - cam rollers are supplied with alternative seal materials, such as high - temperature **FPM** - contacting seals.

Grease filling

ART cam rollers incorporating either seals or shields (suffixes) are supplied grease filled from the factory with a proven high quality, lithium soap based rolling bearing grease suitable for operating temperatures of **-30°C** up to **+110°C**.

Although cam rollers, operating under normal

conditions, run generally maintenance free.

Some application require additional lubrication where high speeds, heavy dust, permanent operating temperatures over 70°C exist.

Double Row cam rollers only feature a lubrication hole in the inner rings to provide a simple and effective relubricating method.

Where relubrication is necessary, it is emphasized that, undue pressure by the regreasing method may cause unnecessary damage to either the seals or shields.

ART cam rollers are supplied with special grease fills according to customer specification or with variable grease fill volumes than the standard.

Cages

Single Row Cam Rollers are standard fitted with pressed steel cages as standard. **Double Row Cam Rollers** feature solid polyamide cages as standard.

Tolerances

ART cam rollers, with cylindrical outer ring diameter, are produced to normal class tolerances (PN) as standard.

For cam rollers with sphered outer ring diameters the outer ring diameter tolerance is double the standard value.

For detailed tolerance values see in the chapter "**Bearing tolerances**" page 28.

Internal clearance

ART cam rollers are produced with **normal internal clearance** group (CN) as standard according to DIN 620.

ART cam rollers are also produced to other internal clearances.

Load carrying capability

Unlike the "normal" rolling element bearings, the outer ring of cam rollers contact their adjacent mating surface on a very small contacting area, this causes deformations of the outer ring.

These deformations are considered by the recommended maximum values for the permissible dynamic and static radial loads as shown in by the product tables.

Equivalent dynamic load

Cam rollers must be calculated as rolling element bearings:

$$P = F_r$$

But, **P** must be $\leq F_r \text{ max}$
(for $F_r \text{ max}$ see product tables)

Equivalent static bearing load

For Cam rollers:

$$P_0 = F_r$$

But, **P₀** must be $\leq F_{0r \text{ max}}$
(for $F_{0r \text{ max}}$ see product tables)

Abutment and Fillet dimensions for cam rollers

The bearing inner ring must contact adjacent surfaces with their side faces only. The radius of inner ring corners must not touch the fillet radius of the shaft shoulder.

Therefore, the largest fillet radius (r_g) must be smaller than the minimum fillet dimension of the cam roller inner rings (r_s) as listed in the product tables.

Since cam rollers normally have point loaded inner rings, their shaft fits may be rather loose, (i.e. according to ISO - tolerance fields g6, h6 or j6).

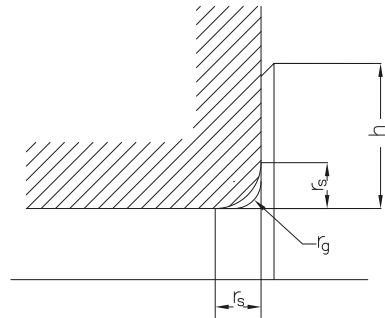

r_{smin}	r_{gmax}	h_{min}
0.6	0.6	2.1
1	1	2.8
1.1	1	3.5
1.5	1.5	4.5
2	2	5.5

Cam Rollers, Single Row

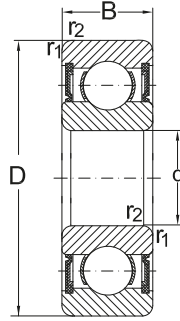

3612...

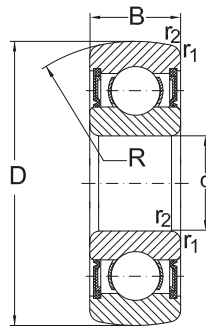

3612...R

Dimensions

Designation

D	d	B	R	r_1, r_2 min.	With cylindrical outer ring	With sphered outer ring
mm						
32	10	9	400	0,6	361200	361200 R
35	12	10	400	0,6	361201	361201 R
40	15	11	400	0,6	361202	361202 R
47	17	12	400	0,6	361203	361203 R
52	20	14	400	1	361204	361204 R
62	25	15	400	1	361205	361205 R
72	30	16	400	1	361206	361206 R
80	35	17	400	1,1	361207	361207 R
85	40	18	400	1,1	361208	361208 R
90	45	19	400	1,1	361209	361209 R

Cam Rollers, Single Row

*Abutment and
fillet dimensions
see on page 714*

Speed rating	Load ratings				Max. permissible radial load		Mass
	as bearing		as cam roller		dyn.	stat.	
	dyn. C_r	stat. C_{0r}	dyn. C_{LR}	stat. C_{0LR}	$F_{r \max}$	$F_{0r \max}$	
min ⁻¹	kN				kN		kg
17000	5,1	2,4	4,6	2	3,4	4,9	0,041
15000	6,8	3,1	6,2	2,6	3,3	4,7	0,052
13000	7,8	3,8	7,1	3,2	5	7,2	0,074
12000	9,6	4,8	8,8	4,2	8,2	11,6	0,11
10000	12,7	6,6	11,4	5,4	7,4	10,6	0,16
8500	14	7,8	12,7	6,8	12,9	18	0,24
7500	19,5	11,2	17,4	9,3	14,3	20,4	0,34
6300	25,5	15,3	22,1	11,8	12,7	18	0,43
5000	32,5	19,8	22,8	13,6	13,4	23,1	0,45
4500	32,5	20,4	22,5	13,7	13,3	22,8	0,50

Cam Rollers, Double Row

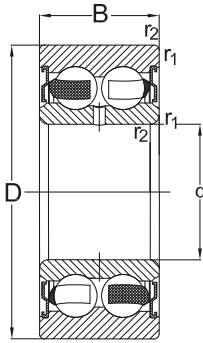

3057...2Z
3067...2Z

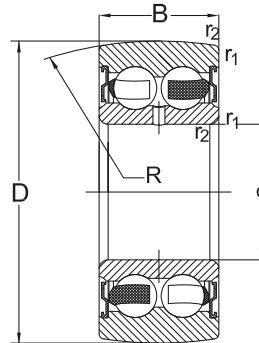

3058...2Z
3068...2Z

Dimensions

Designation

D	d	B	R	r_1, r_2 min.	With cylindrical outer ring	With sphered outer ring
mm						
32	10	14	400	0,6	305700 2Z	305800 2Z
	10	14	400	0,6	305700 2RS	305800 2RS
35	12	15,9	400	0,6	305701 2Z	305801 2Z
	12	15,9	400	0,6	305701 2RS	305801 2RS
40	15	15,9	400	0,6	305702 2Z	305802 2Z
	15	15,9	400	0,6	305702 2RS	305802 2RS
47	17	17,5	400	0,6	305703 2Z	305803 2Z
	17	17,5	400	0,6	305703 2RS	305803 2RS
	15	19	400	1,0	306702 2Z	306802 2Z
	15	19	400	1,0	306702 2RS	306802 2RS
52	20	20,6	400	1	305704 2Z	305804 2Z
	20	20,6	400	1	305704 2RS	305804 2RS
	17	22,2	400	1,0	306703 2Z	306803 2Z
	17	22,2	400	1,0	306703 2RS	306803 2RS
62	25	20,6	400	1	305705 2Z	305805 2Z
	25	20,6	400	1	305705 2RS	305805 2RS

Cam Rollers, Double Row

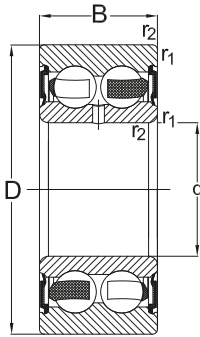

3057...2RS
3067...2RS

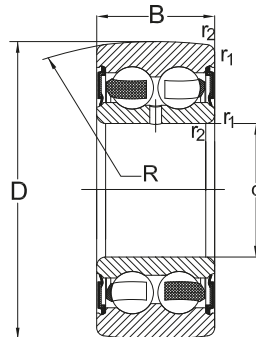

3058...2RS
3068...2RS

*Abutment and
fillet dimensions
see on page 714*

Speed rating	Load ratings as bearing		Load ratings as cam roller		Max. permissible radial load		Mass
	dyn. C_r	stat. C_{0r}	dyn. C_{LR}	stat. C_{0LR}	dyn. $F_{r\max}$	stat. $F_{0r\max}$	
min^{-1}	kN				kN		kg
13000	7,8	4,5	7,4	4,1	9	12,9	0,062
8500	7,8	4,5	7,4	4,1	9	12,9	0,062
11000	10,6	5,9	10	5,2	8,3	12	0,078
7300	10,6	5,9	10	5,2	8,3	12	0,078
10000	11,9	7,1	11,1	6,4	12,2	17,6	0,10
6500	11,9	7,1	11,1	6,4	12,2	17,6	0,10
9000	14,6	9	13,8	8,3	19,3	27,5	0,16
6000	14,6	9	13,8	8,3	19,3	27,5	0,16
10000	17,7	10,3	14,6	9,2	12,5	18,4	0,15
6500	17,7	10,3	14,6	9,2	12,5	18,4	0,15
8000	19,5	12,5	18,2	11	17	24,5	0,22
5300	19,5	12,5	18,2	11	17	24,5	0,22
9500	21,1	12,5	17,2	11	15,5	22,2	0,20
6300	21,1	12,5	17,2	11	15,5	22,2	0,20
7000	21,2	14,6	19,9	13,4	30,5	44	0,32
4500	21,2	14,6	19,9	13,4	30,5	44	0,32

Cam Rollers, Double Row

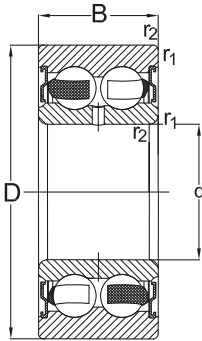

3057...2Z
3067...2Z

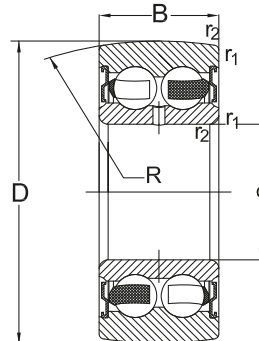

3058...2Z
3068...2Z

Dimensions

Designation

D	d	B	R	r_1, r_2 min.	With cylindrical outer ring	With sphered outer ring
mm						
62	20	22,2	400	1,1	306704 2Z	306804 2Z
	20	22,2	400	1,1	306704 2RS	306804 2RS
72	30	23,8	400	1	305706 2Z	305806 2Z
	30	23,8	400	1	305706 2RS	305806 2RS
	25	25,4	400	1,1	306705 2Z	306805 2Z
	25	25,4	400	1,1	306705 2RS	306805 2RS
80	35	27	400	1,1	305707 2Z	305807 2Z
	35	27	400	1,1	305707 2RS	305807 2RS
	30	30,2	400	1,1	306706 2Z	306806 2Z
	30	30,2	400	1,1	306706 2RS	306806 2RS
90	35	34,9	400	1,5	306707 2Z	306807 2Z
	35	34,9	400	1,5	306707 2RS	306807 2RS
100	40	36,5	400	1,5	306708 2Z	306808 2Z
	40	36,5	400	1,5	306708 2RS	306808 2RS

Cam Rollers, Double Row

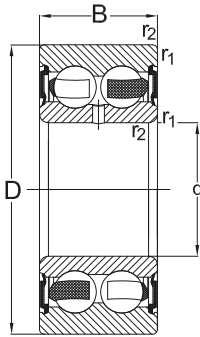

3057...2RS
3067...2RS

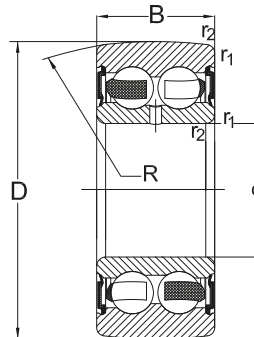

3058...2RS
3068...2RS

*Abutment and
fillet dimensions
see on page 714*

Speed rating	Load ratings as bearing		Load ratings as cam roller		Max. permissible radial load		Mass
	dyn. C_r	stat. C_{0r}	dyn. C_{LR}	stat. C_{0LR}	dyn. $F_{r\max}$	stat. $F_{0r\max}$	
min^{-1}	kN				kN		kg
9000	24,5	15,8	21,1	14,5	27	29	0,34
6000	24,5	15,8	21,1	14,5	27	29	0,34
6000	29,6	21,2	27,6	18,6	34	49	0,49
4000	29,6	21,2	27,6	18,6	34	49	0,49
7900	32,5	21,6	27,5	19,5	34,5	39	0,5
5200	32,5	21,6	27,5	19,5	34,5	39	0,5
5300	39	28,5	35,1	24	31	44	0,65
3500	39	28,5	35,1	24	31	44	0,65
6200	45,5	31,5	36,5	26,5	43,5	53	0,67
4100	45,5	31,5	36,5	26,5	43,5	53	0,67
5100	56	39,5	44,5	33	39,5	66	0,95
3400	56	39,5	44,5	33	39,5	66	0,95
4700	69	49,5	56	42	70	84	1,2
4700	69	49,5	56	42	70	84	1,2



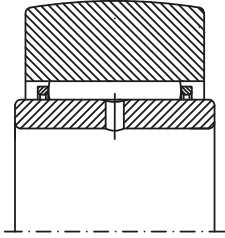

STO

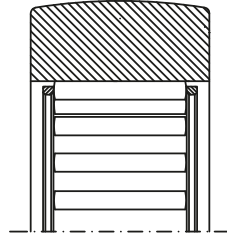

RSTO

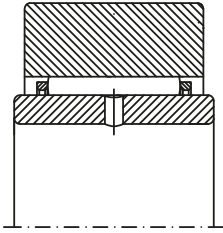

STO...X

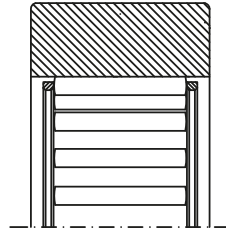

RSTO...X

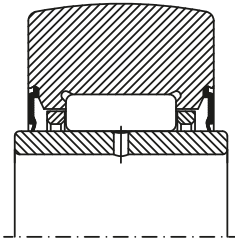

NA22...2RS

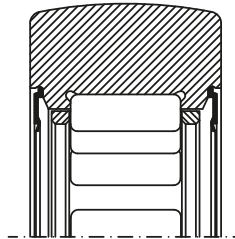

RNA22...2RS

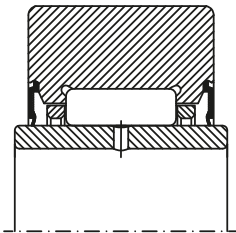

NA22...2RS.X

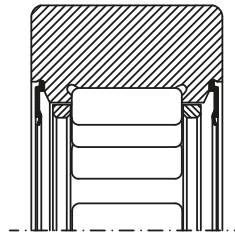

RNA22...2RS.X

Sealed support rollers, without inner rings, are also produced, namely **RNA 22...2RS**.

For these types both the needle rollers and the rubbing seals run on the contacting shaft surface.

Support Rollers with axial guidance

These types of supporting rollers are also to accommodate additional thrust loads as they occur, due to aligning errors or if rollers run out of line.

That is why no extra external guiding surfaces are required.

Where high axial loads are anticipated effective axial support of side washers must be achieved by the adjacent machine components.

Support rollers, type **STO..2Z**

STO...2Z - type support rollers are designed similar to the **STO** - type but have two loose side plates to accept axial forces.

These types of support rollers are separable, this enables simple mounting of the rollers due to the separable parts.

Particular attention must be paid to the adequate axial camping of loose side washers during mounting.

The side plates of **STO...2Z** - type support rollers must not have any axial play when they are mounted.

Support rollers, type **NATR**

The side washers of **NATR** - type needle roller support rollers are pressed into the inner ring to ensure guidance of the outer ring and the needle roller and cage assembly.

Therefore, these roller types are non - separable. **NATR** - type needle roller support roller are optimum for applications where the rollers are exposed to high radial loads at high speeds.

The sealed support rollers, namely, **NATR..PP**, which feature integrated rubbing seals on each side of the outer ring are very suitable for operating in harsh conditions (e.g. heavy dust, dirt and other contaminants).

Support rollers, type **NATV**

NATV-type rollers are identical to the **NATR**-type except they have no fitted cage (i.e. full complement type).

This enables an increased numbers of needle roller to be fitted in the available space (i.e. full circumferentially and radially). Therefore, significantly higher "basic" load ratings are achieved.

NATV type full complement rollers are unsuitable for high speed applications due to the differing kinematic operating condition. Also they must be re-lubricated more frequently.

For applications of harsh operating conditions the sealed support roller, namely, **NATV...PP** is also available.

NUTR - type support rollers

The base internal design of **NUTR** - type support rollers is similar to that of double row cylindrical roller bearings.

Since the outer ring has tow shoulders these support rollers are able to accommodate greater thrust loads.

NUTR - type support rollers are non separable.

The separate loose ribs of these type are retained using either cupped washers pressfitted into the outer ring or with lamellar rings which sit in the formed circumferential grooves machined in the loose rib outer diameter.

Both methods also act as a gap seal.

Due to do their full complement design, **NUTR** - type support roller feature a maximum load rating but they must be more frequently re-lubrication.

For extra heavy duty applications, particularly where heavy shock loads occur **NUTR** - type support rollers are available with an extra - radially thick walled outer ring (see sketch).

ART's extra heavy duty **NUTR** -type support rollers with increased outer ring wall thickness are identified by the fact that their nominal diameters are included in their designation.

Examples:

NUTR 1747

or

NUTR 50110.

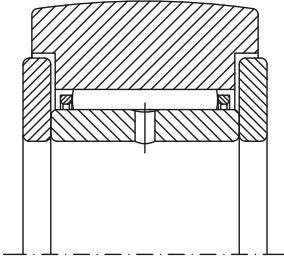

STO...2Z

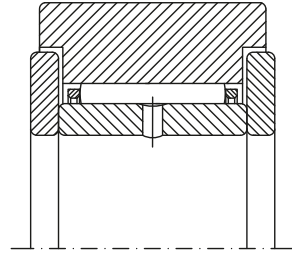

STO...2ZX

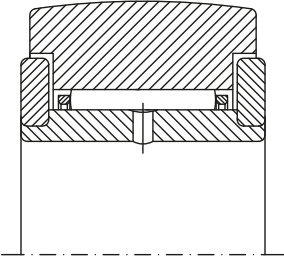

NATR

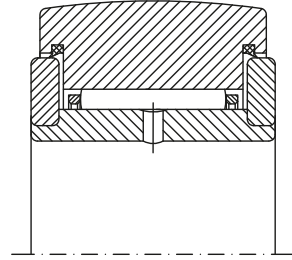

NATR...PP

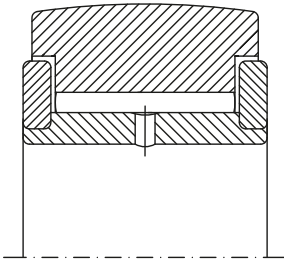

NATV

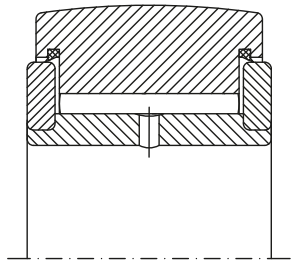

NATV...PP

Tolerance values of ISO - tolerance fields F6 and h12 [μm]

Nominal dimension		>	3	6	10	18	30	50
	[mm]	≤	6	10	18	30	50	80
ISO - Tolerance field	F6	min	+10	+13	+16	+20	+25	+30
		max	+18	+22	+27	+33	+41	+49
ISO - Tolerance field	h12	min	-120	-150	-180	-210	-250	-300
		max	0	0	0	0	0	0

All **ART support rollers** are produced with **crowned outer ring diameter as standard** they are also available with parallel (cylindrical) outer diameters indicated by the suffix "**X**"; see the relevant designs.

Material of seals

Several types of ART support rollers, such as series **NA22...2RS**, **NATR .. PP** und **NATV...PP** are also available in sealed versions.

These support rollers feature contacting seals made from wear - resistant synthetic rubber compound (**NBR**) that provides an efficient and effective seal against the penetration of impurities or the escape of grease.

The synthetic rubber used for these contacting seals is satisfactory for operation temperatures of **-30°C** up to **+120°C**.

Grease filling

All **ART Support rollers** are already supplied filled with a high quality, lithium - soaped bearing grease as standard.

This lubricant is adequate for operating temperatures of **-30°C** up to ca. **+110°C**. Although support rollers under normal operating conditions usually run maintenance - free, they may require more frequent re - lubrication under certain unfavourable operating conditions such as heavy dust, high speeds, permanent operating temperatures of more than **70°C**, and the presence of increased humidity etc.

Therefore a **ART support rollers** feature a lubrication hole in the inner ring to provide the possibility of re-lubricating the rollers, when necessary.

It must be considered where relubrication is necessary, with a satisfactory grease, the force of pressure to re-grease must be of a level not to cause permanent damage to either the seals or shields.

ART also produce roller with alternative grease **fi** according to customer's specification upon order request.

Cages

ART support rollers, with cages fitted, have normally pressed steel cages as standard. Only small support rollers without axial guidance, series **STO** and **RSTO**, respectively, are fitted with solid polyamide cages (suffix **TN**), as standard.

Tolerances

ART support rollers are produced to normal tolerance class (**PN**) as standard, according to DIN - standard DIN 620.

The exceptions being the outer ring outer diameter tolerance of crowned outer rings and the width tolerance of supporting roller of series **STO ...2Z**, **NATR**, **NATV** and **NUTR**.

The tolerance for the outer ring diameter of support rollers with sphered outer ring is uniform at:

0 / -0,05 mm

The width tolerance of support rollers of series **STO ...2Z**, **NATR**, **NATV** and **NUTR** is lateral and lies in the ISO - tolerance field **h12**.

The tolerance for the **inside diameter of the needle roller complement, (F)**, of **RSTO** and **RNA 22...2RS** - type support rollers that are used without inner rings, is lateral in the ISO - tolerance field **F6**.

Values of ISO - tolerance field F6 and h12 are listed in the table below. For detailed values of tolerances to DIN 620 see chapter "**Bearing tolerances**" page 28.

Internal Clearance

ART Support rollers are produced to normal internal clearance group (**CN**) as standard according to DIN 620.

Load carrying capability

Unlike "normal" rolling element bearings, the outer ring of support rollers contact the adjacent parts with a very small contacting surface only.

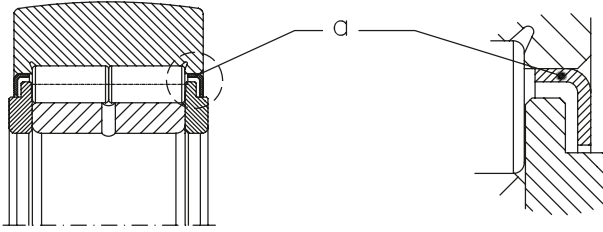

NUTR (a)

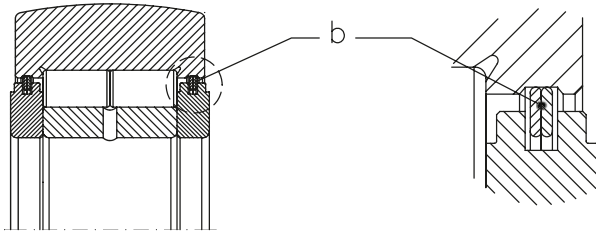

NUTR (b)

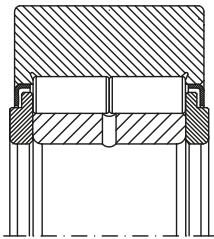

NUTR...X

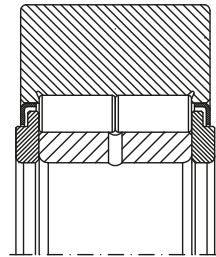

NUTR...XXXX

This causes deformations of the outer ring. These are considered by the recommended maximum values for the permissible dynamic and static radial loads as given by the product tables.

Equivalent dynamic load

Where Support rollers must be calculated as rolling element bearings:

$$P = F_r$$

But, P must be $\leq F_r \text{ max}$
(for $F_r \text{ max}$ see product tables)

Equivalent static bearing load

For Support rollers:

$$P_0 = F_r$$

But, P_0 must be $\leq F_{0r} \text{ max}$
(for $F_{0r} \text{ max}$ see product tables)

Design of adjacent machine components

For support rollers of the series **STO**, **RSTO**, **NA22..2RS** and **RNA22..2RS**, an effective axial guidance of the outer rings must be provided by satisfactory designed surrounding parts.

These guiding surfaces must have a clean and plain machined surface, minimum fine turned, without any burrs.

These guide surfaces which are machined should reach **50%**, or greater, of the outer ring radial wall section or the equivalent diameter.

Hardened guide surfaces, however, feature a higher wear - resistance and may therefore be smaller in diameter.

RSTO and **RNA22..2RS** - type support rollers that run directly on a shaft require an **axial play** of 0,2 mm minimum between the lateral guiding surfaces in mounted condition.

The diameter of the supposed shaft raceway should have a diameter tolerance according to **k5**.

The shaft or pin have to fulfil certain requirements in terms of hardness, dimensional and geometric accuracy.

For detailed information on the design requirements see the chapter "**Bearing application**" on page 46.

For support roller which are exposed to high axial loads, effective lateral support of their side washers is necessary.

Since Support rollers usually have point loaded inner rings, their shaft may be rather loose (i.e. according to ISO - tolerance fields **g6**, **h6** or **j6**).

Abutment and Fillet dimensions for Support rollers

The bearing inner ring must contact adjacent surfaces with their side faces only. The fillet radius of inner ring corners must not touch the fillet radius of shaft shoulder.

Therefore, the largest fillet radius (r_g) must be smaller than the minimum fillet dimension of the Support roller inner rings (r_{gs}) as listed in the product tables.

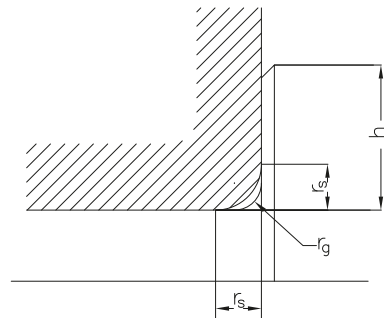

r_{gsmin}	r_{gmax}	h_{min}
0,6	0,6	2,1
1	1	2,8
1,1	1	3,5
1,5	1,5	4,5
2	2	5,5

Support Rollers without axial guidance

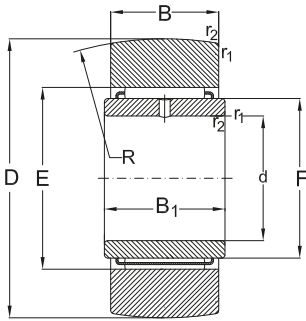

STO...

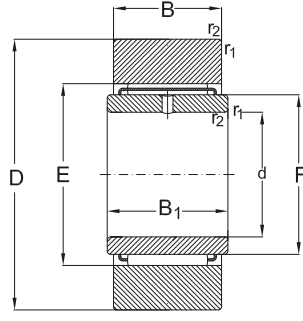

STO...X

Dimensions

Designation

D	d	B	B ₁	r ₁ , r ₂ min.	R	with sphered outer ring	with cylindrical outer ring
mm							
16	-	7,8	-	0,3	500	RST05 TN	RST05 XTN
19	-	9,8	-	0,3	500	RST06	RST06 X
	6	9,8	10	0,3	500	ST06	ST06 X
24	-	9,8	-	0,3	500	RST08	RST08 X
	8	9,8	10	0,3	500	ST08	ST08 X
30	-	11,8	-	0,3	500	RST010	RST010 X
	10	11,8	12	0,3	500	ST010	ST010 X
32	-	11,8	-	0,3	500	RST012	RST012 X
	12	11,8	12	0,3	500	ST012	ST012 X
35	-	11,8	-	0,3	500	RST015	RST015 X
	15	11,8	12	0,3	500	ST015	ST015 X
40	-	15,8	-	0,3	500	RST017	RST017 X
	17	15,8	16	0,3	500	ST017	ST017
47	-	15,8	-	0,3	500	RST020	RST020 X
	20	15,8	16	0,3	500	ST020	ST020 X

Support Rollers without axial guidance

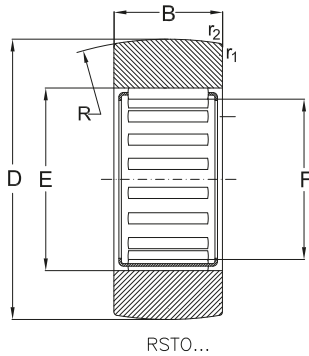

RSTO...

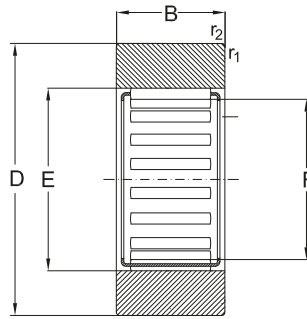

RSTO...X

*Recommended
Abutment and
fillet dimensions
see on page 728*

Dimensions		Speed rating	Load ratings				max. permissible radial load		Mass
F	E		as bearing		as support roller		dyn.	stat.	
			dyn. C_r	stat. C_{Or}	dyn. C_{LR}	stat. C_{OLR}	$F_{r\max}$	$F_{Or\max}$	
mm		min^{-1}	kN				kN		kg
7	10	24000	2,65	2,5	2,36	2,5	2,9	3	0,01
10	13	18000	5,2	6,55	4	4,5	3,9	5,6	0,01
10	13	18000	5,2	6,55	4	4,5	3,9	5,6	0,02
12	15	16000	5,6	7,65	4,5	5,4	6,4	7,5	0,02
12	15	16000	5,6	7,65	4,5	5,4	6,4	7,5	0,03
14	20	12000	10	10,8	8,15	8,8	7,35	10,6	0,04
14	20	12000	10	10,8	8,15	8,8	7,35	10,6	0,05
16	22	10000	10,6	12	8,3	9,8	7,35	10,8	0,05
16	22	10000	10,6	12	8,3	9,8	7,35	10,8	0,06
20	26	7000	12,5	15,6	8,65	10,6	6,55	11	0,05
20	26	7000	12,5	15,6	8,65	10,6	6,55	11	0,06
22	29	6300	18,3	23,6	13,2	17,6	10,8	18	0,09
22	29	6300	18,3	23,6	13,2	17,6	10,8	18	0,11
25	32	5300	19	26	14,3	15,6	15,6	22,4	0,13
25	32	5300	19	26	14,3	15,6	15,6	22,4	0,15

Support Rollers without axial guidance

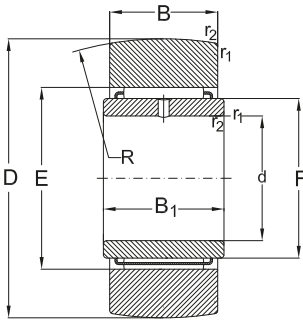

STO...

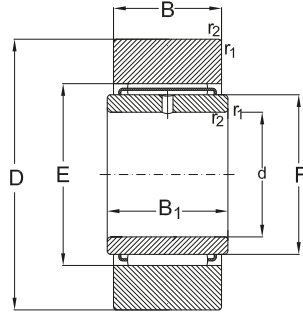

STO...X

Dimensions

Designation

D	d	B	B ₁	r ₁ , r ₂ min.	R	with sphered outer ring	with cylindrical outer ring
mm							
52	-	15,8	-	0,3	500	RSTO25	RSTO25 X
	25	15,8	16	0,3	500	STO25	STO25 X
62	-	19,8	-	0,6	500	RSTO30	RSTO30 X
	30	19,8	20	0,6	500	STO30	STO30 X
72	-	19,8	-	0,6	500	RSTO35	RSTO35 X
	35	19,8	20	0,6	500	STO35	STO35 X
80	-	19,8	-	1	500	RSTO40	RSTO40 X
	40	19,8	20	1	500	STO40	STO40 X
85	-	19,8	-	1	500	RSTO45	RSTO45 X
	45	19,8	20	1	500	STO45	STO45 X
90	-	19,8	-	1	500	RSTO50	RSTO50 X
	50	19,8	20	1	500	STO50	STO50 X

Support Rollers without axial guidance

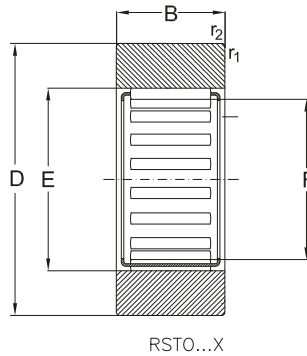
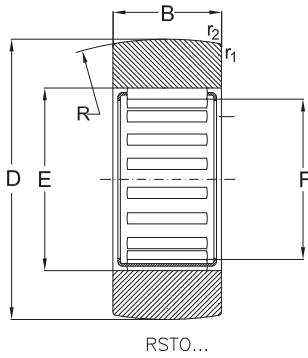

*Recommended
Abutment and
fillet dimensions
see on page 728*

Dimensions		Speed rating	Load ratings				max. permissible radial load		Mass
F	E		as bearing		as support roller		dyn.	stat.	
			dyn. C_r	stat. C_{Or}	dyn. C_{LR}	stat. C_{OLR}	$F_{r\max}$	$F_{Or\max}$	
mm		min^{-1}	kN				kN	kg	
30	37	4300	21,2	31,5	15	22,8	16	23,6	0,15
30	37	4300	21,2	31,5	15	22,8	16	23,6	0,18
38	46	3000	31,5	52	21,2	34,5	22	33,5	0,26
38	46	3000	31,5	52	21,2	34,5	22	33,5	0,31
42	50	2400	33,5	57	24	40,5	31,5	43	0,38
42	50	2400	33,5	57	24	40,5	31,5	43	0,44
50	58	1800	36,5	68	23,8	39,0	32,5	45	0,42
50	58	1800	36,5	68	23,8	39,0	32,5	45	0,53
55	63	1600	38	75	24,5	43,0	33,5	45,5	0,45
55	63	1600	38	75	24,5	43,0	33,5	45,5	0,58
60	68	1500	40	80	25	45,5	34,5	45,5	0,48
60	68	1500	40	80	25	45,5	34,5	45,5	0,62

Support Rollers with axial guidance

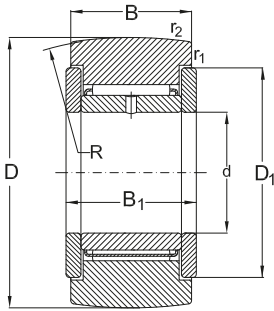

STO...2Z

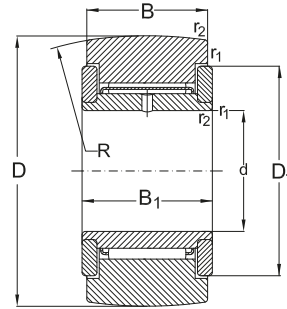

NATR

Dimensions

D d B B₁ r₁, r₂
min. r₃, r₄
min. R

Designation

with sphered
outer ring with cylindrical
outer ring

mm

16	5	11	12	0,1	-	500	NATR5	NATR5 X
	5	11	12	0,1	-	500	NATV5	NATV5 X
19	6	11	12	0,1	-	500	NATR6	NATR6 X
	6	11	12	0,1	-	500	NATV6	NATV6 X
	6	13,8	14	0,3	-	500	STO6 2Z	STO6 2ZX
24	8	14	15	0,3	-	500	NATR8	NATR8 X
	8	14	15	0,3	-	500	NATV8	NATV8 X
	8	13,8	14	0,3	-	500	STO8 2Z	STO8 2ZX
30	10	14	15	0,6	-	500	NATR10	NATR10 X
	10	14	15	0,6	-	500	NATV10	NATV10 X
	10	15,8	16	0,3	-	500	STO10 2Z	STO10 2ZX
32	12	14	15	0,6	-	500	NATR12	NATR12 X
	12	14	15	0,6	-	500	NATV12	NATV12 X
	12	15,8	16	0,3	-	500	STO12 2Z	STO12 2ZX
35	15	18	19	0,6	-	500	NATR15	NATR15 X
	15	18	19	0,6	-	500	NATV15	NATV15 X

Support Rollers with axial guidance

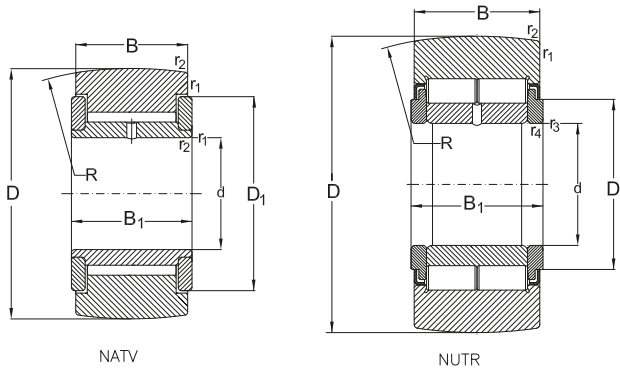

*Recommended
Abutment and
fillet dimensions
see on page 728*

Dimensions		Speed rating	Load ratings				max. permissible		Mass
D	D ₁		as bearing	as support roller		radial load			
mm		min ⁻¹	dyn. C _r	stat. C _{0r}	dyn. C _{LR}	stat. C _{OLR}	dyn. F _{r max}	stat. F _{0r max}	kg
16	12	22000	3,7	3,9	3,1	3,2	2,9	4,1	0,02
	12	11000	6	8,8	4,7	6,5	4	5,7	0,02
19	14	20000	4,15	4,75	3,25	3,8	3,45	5,5	0,02
	14	10000	6,9	11	5,3	8	5,1	7,4	0,02
	15	18000	5,1	6,55	4	5,1	4,2	5,85	0,03
24	19	17000	6,6	7,8	5,3	6,1	4,8	7,35	0,04
	19	8500	9,7	16	7,4	11,4	7,4	10,4	0,04
	18	16000	5,6	7,65	4,65	6,4	7,1	7,5	0,04
30	23	15000	7,8	9,65	6,4	8	7,1	11,2	0,06
	23	7500	11,4	19,3	8,9	14,6	11	15,6	0,07
	23	12000	10	10,8	8,3	8,8	8,15	11	0,07
32	25	14000	8,4	10,8	6,6	8,5	7,1	10	0,07
	25	7000	12,3	22	9,3	15,3	10,6	15	0,07
	25	10000	10,6	12	8,3	9,3	8	11,2	0,08
35	27	13000	12,3	19,3	9,5	13,7	11,4	16,3	0,10
	27	6700	17,2	35,5	12,3	23,2	14,6	20,8	0,11

Support Rollers with axial guidance

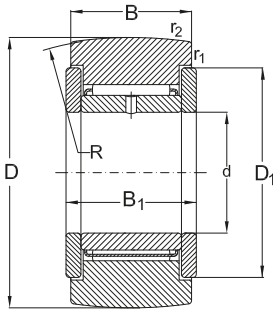

STO...2Z

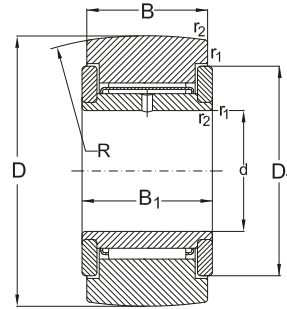

NATR

Dimensions

D d B B₁ r₁, r₂
min. r₃, r₄
min. R

Designation

with sphered
outer ring with cylindrical
outer ring

mm

35	15	18	19	0,6	0,3	500	NUTR15	NUTR15 X
	15	15,8	16	0,3	-	500	STO15 2Z	STO15 2ZX
40	17	20	21	1	-	500	NATR17	NATR17 X
	17	20	21	1	-	500	NATV17	NATV17 X
	17	20	21	1	0,3	500	NUTR17	NUTR17 X
	17	19,8	20	0,3	-	500	STO17 2Z	STO17 2ZX
42	15	18	19	0,6	0,3	500	NUTR1542	NUTR1542 X
47	20	24	25	1	-	500	NATR20	NATR20 X
	20	24	25	1	-	500	NATV20	NATV20 X
	17	20	21	1	0,3	500	NUTR1747	NUTR1747 X
	20	24	25	1	0,3	500	NUTR20	NUTR20 X
	20	19,8	20	0,3	-	500	STO20 2Z	STO20 2ZX
52	25	24	25	1	-	500	NATR25	NATR25 X
	25	24	25	1	-	500	NATV25	NATV25 X
	20	24	25	1	0,3	500	NUTR2052	NUTR2052 X
	25	24	25	1	0,3	500	NUTR25	NUTR25 X

Support Rollers with axial guidance

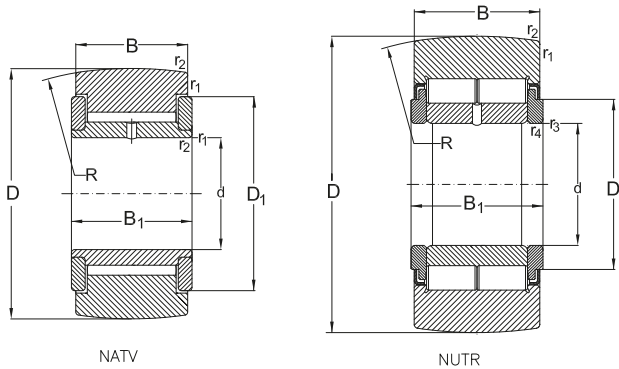

*Recommended
Abutment and
fillet dimensions
see on page 728*

Dimensions		Speed rating	Load ratings				max. permissible radial load		Mass
D	D ₁		as bearing dyn. C _r	stat. C _{0r}	as support roller dyn. C _{LR}	stat. C _{OLR}	dyn. F _{r max}	stat. F _{0r max}	
mm		min ⁻¹	kN				kN	kg	
35	20	5600	24,2	28,5	16,8	17,6	8,7	12,2	0,10
	30	7000	12,3	15,6	8,8	10,6	7,8	6,95	0,09
40	32	10000	13,4	20,4	10,5	14,6	12,5	18	0,14
	32	5600	19,4	40	14,2	26,5	17	24,5	0,15
	22	5300	26	32	19	20	14	22,2	0,15
	33	6300	18,3	23,6	13,2	16,6	11,4	18,6	0,15
42	20	5600	24,2	28,5	20,1	17,6	21,6	31	0,16
47	37	9500	18,7	32,5	14,7	24,5	23,6	33,5	0,25
	37	5300	26	60	19,4	41,5	30,5	43	0,26
	22	5300	26	32	22	27	30	43	0,22
	27	4500	39	49	28,6	33,5	17	25	0,25
	37	5300	19	26	14,6	19,6	16,6	22,8	0,2
52	42	8000	20,5	38	14,7	25,5	21,6	31	0,28
	42	4300	28,6	72	19,8	44	28,5	40,5	0,29
	27	4500	39	49	30	39	30	42,5	0,32
	31	3800	44,6	61	29,7	36	18	25,5	0,28

Support Rollers with axial guidance

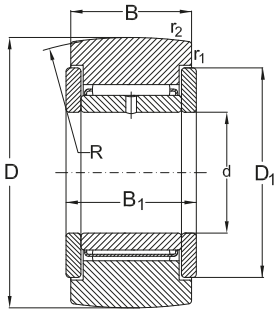

STO...2Z

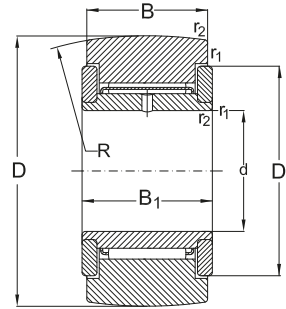

NATR

Dimensions

D d B B₁ r₁, r₂
min. r₃, r₄
min. R

Designation

with sphered
outer ring with cylindrical
outer ring

mm

52	25	19,8	20	0,3	-	500	STO25 2Z	STO25 2ZX
62	30	28	29	1	-	500	NATR30	NATR30 X
	30	28	29	1	-	500	NATV30	NATV30 X
	25	24	25	1	0,3	500	NUTR 2562	NUTR2562 X
	30	28	29	1	0,3	500	NUTR 30	NUTR30 X
	30	24,8	25	0,6	-	500	STO30 2Z	STO30 2ZX
72	35	28	29	1,1	-	500	NATR35	NATR35 X
	35	28	29	1,1	-	500	NATV35	NATV35 X
	30	28	29	1	0,3	500	NUTR3072	NUTR3072 X
	35	28	29	1,1	0,3	500	NUTR35	NUTR35 X
	35	24,8	25	0,6	-	500	STO35 2Z	STO35 2ZX
80	40	30	32	1,1	-	500	NATR40	NATR40 X
	40	30	32	1,1	-	500	NATV40	NATV40 X
	35	28	29	1,1	0,6	500	NUTR3580	NUTR3580 X
	40	30	32	1,1	0,6	500	NUTR40	NUTR40 X
	40	25,8	26	0,6	-	500	STO40 2Z	STO40 2ZX

Support Rollers with axial guidance

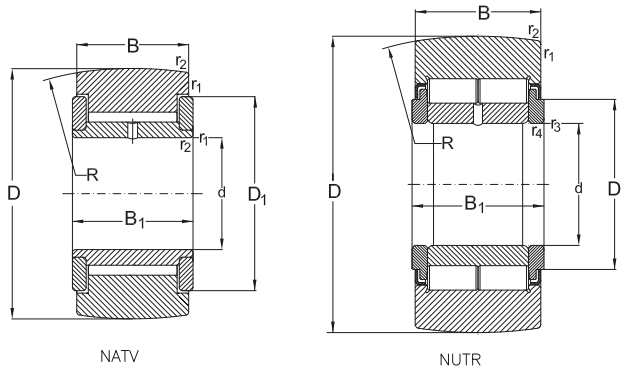

*Recommended
Abutment and
fillet dimensions
see on page 728*

Dimensions		Speed rating	Load ratings				max. permissible radial load		Mass
D	D ₁		as bearing		as support roller		dyn.	stat.	
mm		min ⁻¹	dyn. C _r	stat. C _{0r}	dyn. C _{LR}	stat. C _{OLR}	F _{r max}	F _{0r max}	kg
52	42	4300	21,2	31,5	15,3	21,6	17	24	0,2
62	51	7000	33	60	22,9	37,5	26,5	38	0,47
	51	3600	44,6	108	29,2	62	34,5	49	0,48
	31	3800	44,6	61	35,8	48	44	63	0,45
	38	3200	60	78	41,3	47,5	24	34,5	0,47
	52	3000	31,4	52	21,2	32	22,8	35,5	0,42
72	58	6000	35,8	69,5	24,6	43	33,5	48	0,64
	58	3000	49,5	129	31,9	72	43	62	0,65
	38	3200	60	78	46,5	61	52	76,5	0,71
	40	2800	65,5	91,5	44	57	33,5	47,5	0,63
	56	2400	31,9	54	22,8	36,5	34	41,5	0,56
80	66	5300	46,8	95	31,9	57	41,5	58,5	0,80
	66	2600	60,5	160	39,1	88	51	73,5	0,89
	44	2800	65,5	91,5	49	68	57	81,5	0,86
	51	2400	91,3	134	57,2	72	32	45,5	0,82
	64	1800	36,5	68	24,5	42,5	35,5	45,5	0,70

Support Rollers with axial guidance

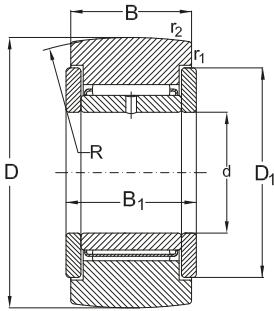

STO...2Z

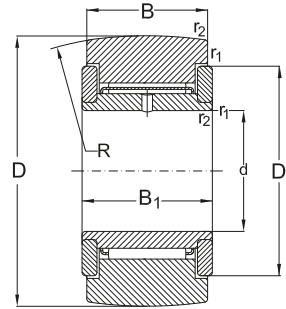

NATR

Dimensions

D d B B₁ r₁, r₂
min. r₃, r₄
min. R

Designation

with sphered
outer ring with cylindrical
outer ring

mm

85	45	30	32	1,1	-	500	NATR45	NATR45 X
	45	30	32	1,1	0,6	500	NUTR45	NUTR45 X
	45	25.8	26	0,6	-	500	STO45 2Z	STO45 2ZX
90	50	30	32	1,1	-	500	NATR50	NATR50 X
	50	30	32	1,1	-	500	NATV50	NATV50 X
	40	30	32	1,1	0,6	500	NUTR4090	NUTR4090 X
	50	30	32	1,1	0,6	500	NUTR50	NUTR50 X
100	45	30	32	1,1	0,6	500	NUTR45100	NUTR45100 X
110	50	30	32	1,1	0,6	500	NUTR50110	NUTR50110 X

Support Rollers with axial guidance

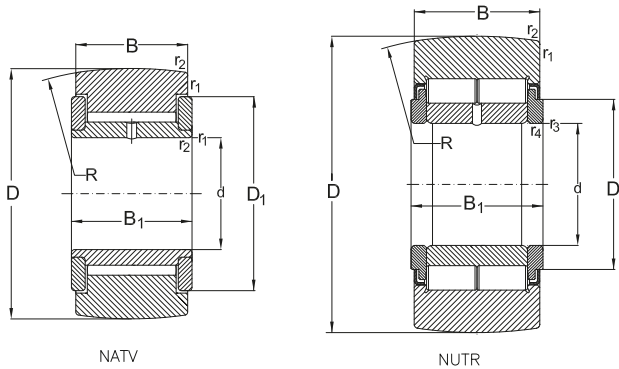

*Recommended
Abutment and
fillet dimensions
see on page 728*

Dimensions		Speed rating	Load ratings				max. permissible radial load		Mass
D	D ₁		as bearing		as support roller		dyn.	stat.	
mm		min ⁻¹	dyn. C _r	stat. C _{0r}	dyn. C _{LR}	stat. C _{OLR}	F _{r max}	F _{0r max}	kg
85	72	5000	48,4	102	31,4	57	40	57	0,91
	55	2000	98,8	146	58,3	75	32,5	46,5	0,88
	69	1600	38	75	24,5	43	36,5	47,5	0,77
90	76	4500	50,1	108	30,8	58,5	40	57	0,96
	76	2000	67,1	193	39,1	93	50	72	1,00
	51	2400	91,3	134	68,2	91,5	63	90	1,16
	60	1900	101	160	58,3	78	32,5	47,5	0,95
100	55	2000	96,8	146	73,6	104	80	114	1,43
110	60	1900	101	160	78,1	116	98	140	1,73

Sealed Support Rollers without axial guidance

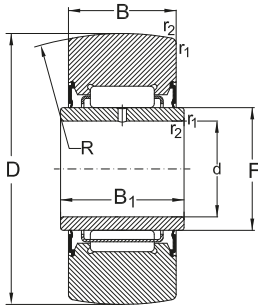

NA22...2RS

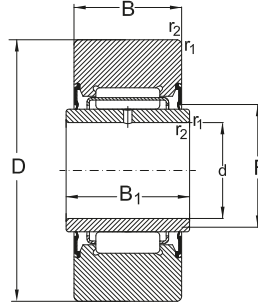

NA22...2RS.X

Dimensions

Designation

D	d	B	B ₁	r ₁ , r ₂ min.	r ₃ , r ₄ min.	R	with sphered outer ring	with cylindrical outer ring
mm								
19	-	-	11,8	0,3	-	500	RNA22/6 2RS	RNA22/6 2RSX
	6	12	11,8	0,3	0,3	500	NA22/6 2RS	NA22/6 2RSX
24	-	-	11,8	0,3	-	500	RNA22/8 2RS	RNA22/8 2RSX
	8	12	11,8	0,3	0,3	500	NA22/8 2RS	NA22/8 2RSX
30	-	-	13,8	0,6	-	500	RNA2200 2RS	RNA2200 2RSX
	10	14	13,8	0,6	0,3	500	NA2200 2RS	NA2200 2RSX
32	-	-	13,8	0,6	-	500	RNA2201 2RS	RNA2201 2RSX
	12	14	13,8	0,6	0,3	500	NA2201 2RS	NA2201 2RSX
35	-	-	13,8	0,6	-	500	RNA2202 2RS	RNA2202 2RSX
	15	14	13,8	0,6	0,3	500	NA2202 2RS	NA2202 2RSX
40	-	-	15,8	1	-	500	RNA2203 2RS	RNA2203 2RSX
	17	16	15,8	1	0,3	500	NA2203 2RS	NA2203 2RSX
47	-	-	17,8	1	-	500	RNA2204 2RS	RNA2204 2RSX
	20	18	17,8	1	0,3	500	NA2204 2RS	NA2204 2RSX

Sealed Support Rollers without axial guidance

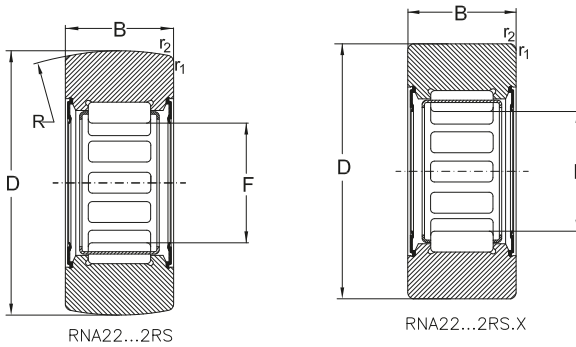

*Recommended
Abutment and
fillet dimensions
see on page 728*

Dimensions		Speed rating	Load ratings				max. permissible radial load		Mass
D	F		as bearing		as support roller		dyn.	stat.	
mm		min ⁻¹	dyn. C _r	stat. C _{0r}	dyn. C _{LR}	stat. C _{OLR}	F _{r max}	F _{0r max}	kg
19	10	16000	4,5	4,1	3,5	3	1,9	2,8	0,01
	10	16000	4,5	4,1	3,5	3	1,9	2,8	0,02
24	12	14000	5,4	5,2	4,5	4,4	5	7,1	0,03
	12	14000	5,4	5,2	4,5	4,4	5	7,1	0,03
30	14	13000	7,4	8,2	6,4	7,2	12	17	0,05
	14	13000	7,4	8,2	6,4	7,2	12	17	0,06
32	16	12000	8,1	9,1	6,9	8,2	11,6	16,6	0,06
	16	12000	8,1	9,1	6,9	8,2	11,6	16,6	0,07
35	20	9500	9,1	12	7,2	9	9,6	13,7	0,06
	20	9500	9,1	12	7,2	9	9,6	13,7	0,07
40	22	9000	11,3	16,3	9,4	12,9	16	22,8	0,09
	22	9000	11,3	16,3	9,4	12,9	16	22,8	0,11
47	25	7500	19,4	22,4	15,4	17,3	17,6	25,5	0,15
	25	7500	19,4	22,4	15,4	17,3	17,6	25,5	0,18

Sealed Support Rollers without axial guidance

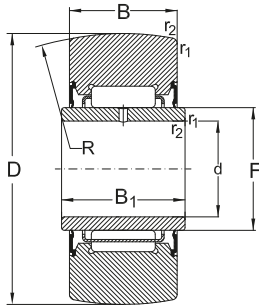

NA22...2RS

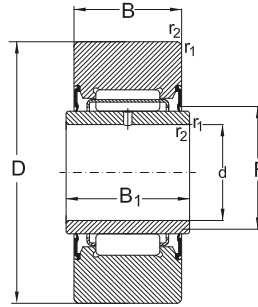

NA22...2RS.X

Dimensions

Designation

D	d	B	B ₁	r ₁ , r ₂ min.	r ₃ , r ₄ min.	R	with sphered outer ring	with cylindrical outer ring
mm								
52	-	-	17,8	1	-	500	RNA2205 2RS	RNA2205 2RSX
	25	18	17,8	1	0,3	500	NA2205 2RS	NA2205 2RSX
62	-	-	19,8	1	-	500	RNA2206 2RS	RNA2206 2RSX
	30	20	19,8	1	0,3	500	NA2206 2RS	NA2206 2RSX
72	-	-	22,7	1,1	-	500	RNA2207 2RS	RNA2207 2RSX
	35	23	22,7	1,1	0,6	500	NA2207 2RS	NA2207 2RSX
80	-	-	22,7	1,1	-	500	RNA2208 2RS	RNA2208 2RSX
	40	23	22,7	1,1	0,6	500	NA2208 2RS	NA2208 2RSX
85	-	-	22,7	1,1	-	500	RNA2209 2RS	RNA2209 2RSX
	45	23	22,7	1,1	0,6	500	NA2209 2RS	NA2209 2RSX
90	-	-	22,7	1,1	-	500	RNA2210 2RS	RNA2210 2RSX
	50	23	22,7	1,1	0,6	500	NA2210 2RS	NA2210 2RSX

Sealed Support Rollers without axial guidance

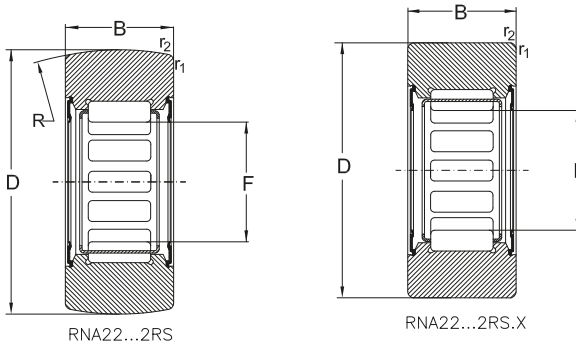

*Recommended
Abutment and
fillet dimensions
see on page 728*

Dimensions		Speed rating	Load ratings				max. permissible radial load		Mass
D	F		as bearing		as support roller		dyn.	stat.	
			dyn. C_r	stat. C_{0r}	dyn. C_{LR}	stat. C_{OLR}	$F_{r\max}$	$F_{0r\max}$	
mm		min^{-1}	kN				kN		kg
52	30	6300	21,6	27,5	16,1	19	17,4	24,6	0,17
	30	6300	21,6	27,5	16,1	19	17,4	24,6	0,20
62	35	5600	22,4	32	17,6	24,5	28,5	40,5	0,29
	35	5600	22,4	32	17,6	24,5	28,5	40,5	0,32
72	42	4800	28,5	46,5	22	34	39	56	0,42
	42	4800	28,5	46,5	22	34	39	56	0,49
80	48	4000	36,9	58,5	27	39	37,5	53	0,515
	48	4000	36,9	58,5	27	39	37,5	53	0,615
85	52	3800	39	63	27,5	41,5	39	56	0,565
	52	3800	39	63	27,5	41,5	39	56	0,661
90	58	3400	40	71	27	41,5	36,5	52	0,59
	58	3400	40	71	27	41,5	36,5	52	0,712

Sealed Support Rollers with axial guidance

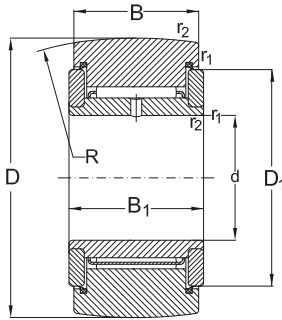

NATR...PP

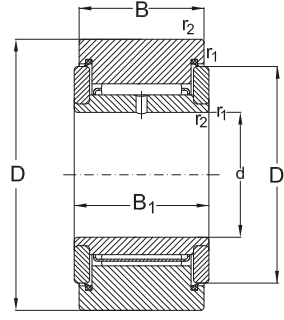

NATR...PPX

Dimensions

D	d	B	B ₁	r ₁ , r ₂ min.	R	Designation	
						with sphered outer ring	with cylindrical outer ring
mm							
16	5	11	12	0,1	500	NATR5 PP	NATR5 PPX
	5	11	12	0,1	500	NATV5 PP	NATV5 PPX
19	6	11	12	0,1	500	NATR6 PP	NATR6 PPX
	6	11	12	0,1	500	NATV6 PP	NATV6 PPX
24	8	14	15	0,3	500	NATR8 PP	NATR8 PPX
	8	14	15	0,3	500	NATV8 PP	NATV8 PPX
30	10	14	15	0,6	500	NATR10 PP	NATR10 PPX
	10	14	15	0,6	500	NATV10 PP	NATV10 PPX
32	12	14	15	0,6	500	NATR12 PP	NATR12 PPX
	12	14	15	0,6	500	NATV12 PP	NATV12 PPX
35	15	18	19	0,6	500	NATR15 PP	NATR15 PPX
	15	18	19	0,6	500	NATV15 PP	NATV15 PPX
40	17	20	21	1	500	NATR17 PP	NATR17 PPX
	17	20	21	1	500	NATV17 PP	NATV17 PPX
47	20	24	25	1	500	NATR20 PP	NATR20 PPX
	20	24	25	1	500	NATV20 PP	NATV20 PPX

Sealed Support Rollers with axial guidance

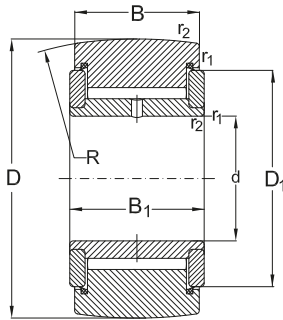

NATV...PP

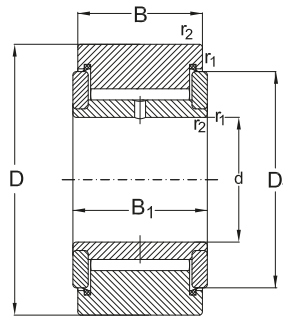

NATV...PPX

*Recommended
Abutment and
fillet dimensions
see on page 728*

Dimensions		Speed rating	Load ratings				max. permissible		Mass
D	F		as bearing		as support roller		radial load		
			dyn. C_r	stat. C_{0r}	dyn. C_{LR}	stat. C_{0LR}	dyn. $F_{r\max}$	stat. $F_{0r\max}$	
mm		min^{-1}			kN				kg
16	12	20000	3,7	3,9	3,1	3,2	2,9	4,2	0,01
	12	11000	6	8,8	4,7	6,5	4	5,7	0,02
19	14	17000	4,15	4,8	3,25	3,8	3,45	5,5	0,02
	14	10000	6,9	11	5,3	8	5,1	7,3	0,02
24	19	15000	6,6	7,8	5,3	6,1	5,2	7,65	0,04
	19	8500	9,6	16	7,4	11,4	7,3	10,4	0,04
30	23	13000	7,8	9,65	6,4	8	7,1	11,2	0,07
	23	7500	11,4	19,3	8,9	14,6	11	15,6	0,07
32	25	11000	8,4	10,8	6,6	8,5	7,1	10	0,07
	25	7000	12,3	22	9,3	15,3	10,6	15	0,07
35	27	10000	12,3	19,3	9,5	13,7	11,4	16,3	0,10
	27	6700	17,2	35,5	12,3	23,2	14,6	20,8	0,11
40	32	9000	13,4	20,4	10,5	14,6	12,5	18	0,14
	32	5600	19,4	40	14,2	26,5	17	24,5	0,15
47	37	8000	18,7	32,5	14,7	24,5	23,6	33,5	0,25
	37	5300	26	60	19,4	41,5	30,5	43	0,26

Sealed Support Rollers with axial guidance

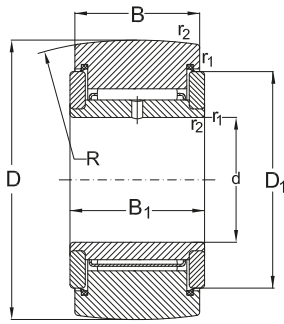

NATR...PP

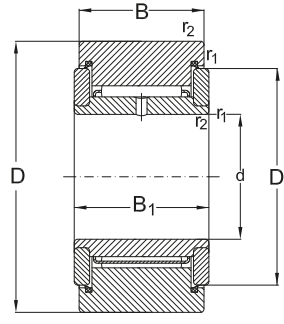

NATR...PPX

Dimensions

D d B B₁ r₁, r₂
min. R

Designation

with sphered outer ring with cylindrical outer ring

mm

52	25	24	25	1	500	NATR25 PP	NATR25 PPX
	25	24	25	1	500	NATV25 PP	NATV25 PPX
62	30	28	29	1	500	NATR30 PP	NATR 30 PPX
	30	28	29	1	500	NATV30 PP	NATV30 PPX
72	35	28	29	1,1	500	NATR35 PP	NATR35 PPX
	35	28	29	1,1	500	NATV35 PP	NATV35 PPX
80	40	30	32	1,1	500	NATR40 PP	NATR40 PPX
	40	30	32	1,1	500	NATV40 PP	NATV40 PPX
85	45	30	32	1,1	500	NATR45 PP	NATR45 PPX
90	50	30	32	1,1	500	NATR50 PP	NATR50 PPX
	50	30	32	1,1	500	NATV50 PP	NATV50 PPX

Sealed Support Rollers with axial guidance

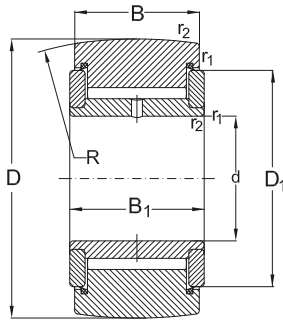

NATV...PP

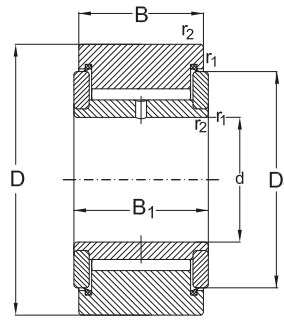

NATV...PPX

*Recommended
Abutment and
fillet dimensions
see on page 728*

Dimensions		Speed rating	Load ratings				max. permissible radial load		Mass
D	F		as bearing		as support roller		dyn.	stat.	
mm		min ⁻¹	dyn. C _r	stat. C _{0r}	dyn. C _{LR}	stat. C _{OLR}	F _{r max}	F _{0r max}	kg
52	42	6700	20,5	38	14,7	25,5	21,6	31	0,28
	42	4300	28,6	72	19,8	44	28,5	40,5	0,29
62	51	5300	33	60	22,9	37,5	26,5	38	0,47
	51	3600	44,6	108	29,2	62	34,5	49	0,48
72	58	4500	38,5	69,5	24,6	43	33,5	48	0,64
	58	3000	49,5	129	31,9	72	43	62	0,65
80	66	4000	46,8	95	31,9	57	41,5	58,5	0,80
	66	2600	60,5	160	39,1	88	51	73,5	0,89
85	72	3600	48,4	102	31,4	57	40	57	0,91
90	76	3400	50,1	108	30,8	58,5	40	57	0,96
	76	2000	67,1	193	39,1	93	50	72	1,00



Rolling Elements

General

Rolling Elements are simple geometric bodies that are produced to very high precision standard by the rolling bearing industry.

Rolling elements are made from hardened bearing steel. They have fine ground or even superfinished surfaces as standard.

Rolling elements such as Balls, Cylindrical Rollers and Needle Rollers are used in a wide variety of Rolling Bearings for a whole spectrum of applications and industries.

Additional to the use in rolling bearings, individual rolling elements are frequently used separately or loose for other requirements or applications, such as Valve Balls, Gauge Rollers, Cycles wheels etc.

The more popular sizes are normally available and supplied loose from stock.

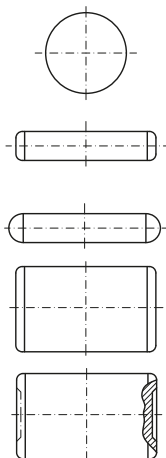

Balls

Standard, Boundary dimensions

Balls of through - hardening

rolling bearing steel

DIN 5401 / Part 1

ISO 3290

Hardness

Balls made from through - hardened rolling bearing steel according to DIN 17 230 generally, have the following hardness values and ranges as stated in the table below.

Ball diameter DW [mm]		Hardness [HRC]	
>	≤	>	≤
-	12,7	62	67
12,7	50,8	60	66
50,8	70	59	65
70	120	57	63
120	-	55	61

Ball grades, Tolerances

ART balls from rolling bearing steel are supplied according to the following tolerances.

The balls are classified and graded according to their diameters, each grade is sorted into individual ball gauges, each gauge is separately packaged.

Each package is clearly identified with ball diameter, grade and gauge. Where there are no specific grade and gauge requirements readily available standard ball diameters will be despatched.

Symbols

- D_W** nominal ball diameter
- D_{Ws}** Single diameter of a ball.
Distance between two parallel planes that contact the surface of the ball.
- D_{Wm}** Mean ball diameter.
Arithmetical mean of largest and smallest (measured) single ball diameter.
- Lot** A defined quantity of balls that have been manufactured under uniform conditions and have therefore similar characteristics.
- D_{WmL}** Mean ball diameter of a ball lot
Arithmetical mean of largest and smallest mean ball diameter (D_{Wm}) within a lot.
- V_{Dws}** Variation of ball diameter.
Difference between largest and smallest measured single diameter of one ball, (D_{Ws})
- V_{DWL}** Variation of ball diameters within a lot.
Difference between largest and smallest mean ball diameter, (D_{Wm}) within a lot.
- tDW** Deviation from spherical form as defined by DIN ISO 1011.
- Gauge** The amount by which the lot mean diameter, (D_{WmL}), differs from the nominal ball diameter, (D_W). This amount being one of a defined series. Each ball gauge is a whole multiple of ball gauge interval (**I**).
- I** Ball gauge interval; Amount in which the permissible deviation of ball diameter is divided.
- R_a** Surface finish roughness, according to DIN 4768
- Grade** Defined combination of quality features such as dimensional and geometrical accuracy, surface roughness, shape and gauge intervals of a specific ball.

Tolerance Values for hardened balls from rolling bearing steel according to ISO 3290

Ball Grade	Tolerances					Gauge interval I	Gauge mean values (deviation range)				
	ΦD_w	V_{Dws}	t_{Dw}	R_a	V_{DwL}						
	>	≤	max	max	max	max					
	mm		μm			μm					
G3	-	12,7	0,08	0,08	0,012	0,13	0,5	-5 ... -0,5	0	+0,5 ... +5	
G5	-	12,7	0,13	0,13	0,020	0,25	1	-5 ... -1	0	+1 ... +5	
G10	-	25,4	0,25	0,25	0,025	0,5	1	-9 ... -1	0	+1 ... +9	
G16	-	25,4	0,4	0,4	0,032	0,8	2	-10 ... -2	0	+2 ... +10	
G20	-	25,4	0,5	0,5	0,040	1	2	-10 ... -2	0	+2 ... +10	
G28	25,4	50,8	0,7	0,7	0,050	1,4	2	-12 ... -2	0	+2 ... +12	
G40	-	101,6	1	1	0,080	2	4	-16 ... -4	0	+4 ... +16	
G100	101,6	152,4	2,5	2,5	0,125	5	5	-20 ... -5	0	+5 ... +20	
	152,4	175	2,5	2,5	0,125	5	10	-40 ... -10	0	+10 ... +40	
G200	175	250	5	5	0,200	10	15	-60 ... -15	0	+15 ... +60	
G500	-	25,4	13	13	0,200	-	50	-50	0	+50	
		25,4	50,8	19	19	0,200	-	75	-75	0	+75
		50,8	76,2	25	25	0,200	-	100	-100	0	+100
		76,2	101,6	32	32	0,200	-	125	-125	0	+125
		101,6	127	38	38	0,200	-	150	-150	0	+150
	127	152,4	44	44	0,400	-	175	-175	0	+175	
G600		all	-	-	-	-	400	-	0	-	
G700		all	-	-	-	-	2000	-	0	-	

Designation

Balls are classified according to their diameters, each grade and gauge is separately packed and despatched.

ART balls made from chromium rolling bearing steel are designated following the system as shown below:

RB 12,7 G10 P4

where:

- RB** Symbols for balls made from chromium rolling bearing steel
- 12,7** Nominal ball diameter D_w [mm]
- G10** Grade **G10**
- P4** Gauge **P4**
(the mean deviation of this specific lot equals +4 μm)

To avoid possible misinterpretations by poor visible printings etc. the **mean deviation** is stated according to the following system:

- P Plus**
e.g. **P4** = mean deviation + 4 μm
- N 0**
- M Minus**
e.g. **M3**=mean deviation - 3 μm

Therefore, the mean diameter deviation of a ball from a specific lot is

$$12,704 \text{ mm} \pm 0,5 \mu\text{m}$$

For a ball with the designation **RB 5,556 G3 M2**, the mean diameter deviation would be:

$$5,554 \pm 0,25 \mu\text{m}$$

Balls from other materials

Additional to the balls produced from chromium bearing steel, **ART** also produce balls suitable for different purposes from alternative materials.

Examples are balls of:

- mild steel, unhardened
- stainless steel
- bronze
- brass, etc.

ART will provide detailed information on request.

Steel Balls

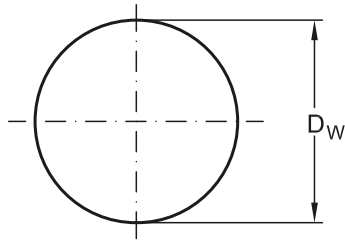

Ball diameter, D_w		Designation	Mass per 100 balls
mm	inch		
0,4	-	RB 0,4	0,0001
0,5	-	RB 0,5	0,0001
1	-	RB 1	0,0004
1,5	-	RB 1,5	0,0014
1,588	1/16	RB 1,588	0,0016
2	-	RB 2	0,0033
2,381	3/32	RB 2,381	0,0055
2,5	-	RB 2,5	0,0064
3	-	RB 3	0,0111
3,175	1/8	RB 3,175	0,0132
3,5	-	RB 3,5	0,0177
3,969	5/32	RB 3,969	0,0257
4	-	RB 4	0,0263
4,5	-	RB 4,5	0,0374
4,762	3/16	RB 4,762	0,0446
5	-	RB 5	0,0514
5,5	-	RB 5,5	0,0679
5,556	7/32	RB 5,556	0,702
6	-	RB 6	0,0882
6,350	1/4	RB 6,350	0,103
6,5	-	RB 6,5	0,113
7	-	RB 7	0,141
7,144	9/32	RB 7,144	0,150
7,5	-	RB 7,5	0,174
7,938	5/16	RB 7,938	0,106

Steel Balls

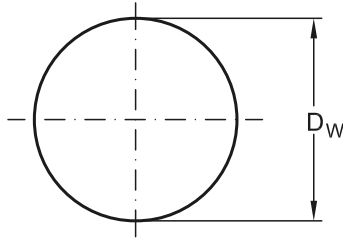

Ball diameter, D_w		Designation	Mass per 100 balls
mm	inch		
8	-	RB 8	0,210
8,5	-	RB 8,5	0,220
8,731	11/32	RB 8,731	0,266
9	-	RB 9	0,330
9,525	3/8	RB 9,525	0,355
10	-	RB 10	0,411
10,319	13/32	RB 10,319	0,443
10,5	-	RB 10,5	0,476
11	-	RB 11	0,547
11,112	7/16	RB 11,112	0,564
11,5	-	RB 11,5	0,625
11,906	15/32	RB 11,906	0,693
12	-	RB 12	0,710
12,5	-	RB 12,5	0,803
12,700	1/2	RB 12,700	0,842
13	-	RB 13	0,903
13,494	17/32	RB 13,494	1,01
14	-	RB 14	1,13
14,288	9/16	RB 14,288	1,20
15	-	RB 15	1,39
15,081	19/32	RB 15,081	1,41
15,875	5/8	RB 15,875	1,65
16	-	RB 16	1,68
16,5	-	RB 16,5	1,85
16,669	21/32	RB 16,669	1,91

Steel Balls

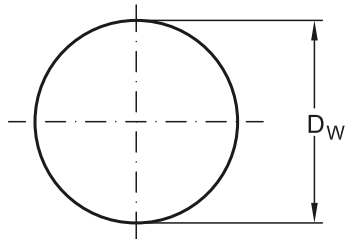

Ball diameter, D_w		Designation	Mass per 100 balls
mm	inch		
17	-	RB 17	2,02
17,462	11/16	RB 17,462	2,19
18	-	RB 18	2,40
18,256	23/32	RB 18,256	2,50
19	-	RB 19	2,82
19,050	3/4	RB 19,050	2,84
19,844	25/32	RB 19,844	3,24
20	-	RB 20	3,29
20,5	-	RB 20,5	3,54
20,638	13/16	RB 20,638	3,62
21	-	RB 21	3,81
22	-	RB 22	4,38
22,225	7/8	RB 22,225	4,52
22,5	-	RB 22,5	4,68
23	-	RB 23	5,00
23,812	15/16	RB 23,812	5,55
24	-	RB 24	5,68
25	-	RB 25	6,42
25,400	1	RB 25,400	6,74
26	-	RB 26	7,23
26,988	1 1/16	RB 26,988	8,08
28	-	RB 28	9,02
28,575	1 1/8	RB 28,575	9,55
30	-	RB 30	11,1
30,162	1 3/16	RB 30,162	11,3

Steel Balls

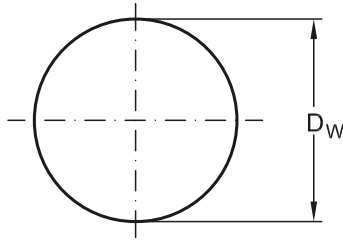

Ball diameter, D_w		Designation	Mass per 100 balls
mm	inch		
31,750	1 1/4	RB 31,750	13,2
32	-	RB 32	13,5
33	-	RB 33	14,8
33,338	1 5/16	RB 33,338	15,2
34	-	RB 34	16,2
34,925	1 3/8	RB 34,925	17,5
35	-	RB 35	17,7
36	-	RB 36	19,2
36,512	1 7/16	RB 36,512	20,0
38	-	RB 38	22,5
38,100	1 1/2	RB 38,100	22,7
39,688	1 9/16	RB 39,688	25,7
40	-	RB 40	26,3
41,275	1 5/8	RB 41,275	29,0
42,862	1 11/16	RB 42,862	32,4
44,450	1 3/4	RB 44,450	36,1
45	-	RB 45	37,4
46,038	1 13/16	RB 46,038	40,3
47,625	1 7/8	RB 47,625	44,6
49,212	1 15/16	RB 49,212	49,0
50	-	RB 50	51,4
50,800	2	RB 50,800	53,9
53,975	2 1/8	RB 53,975	64,6
55	-	RB 55	67,9
57,15	2 1/4	RB 57,15	76,7

Steel Balls

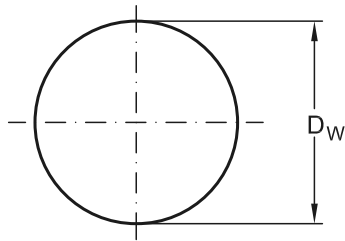

Ball diameter, D_w		Designation	Mass per 100 balls
mm	inch		
60	-	RB 60	88,2
60,325	2 3/8	RB 60,325	90,2
63,500	2 1/2	RB 63,500	103
65	-	RB 65	113
66,675	2 5/8	RB 66,675	122
69,850	2 3/4	RB 69,850	140
70	-	RB 70	141
73,025	2 7/8	RB 73,025	160
75	-	RB 75	174
76,200	3	RB 76,200	182
80	-	RB 80	210
82,550	3 1/4	RB 82,550	231
85	-	RB 85	252
88,900	3 1/2	RB 88,900	289
90	-	RB 90	300
95	-	RB 95	352
95,250	3 3/4	RB 95,250	355
100	-	RB 100	411
110	-	RB 110	547
120	-	RB 120	710
127	5	RB 127	842
150	-	RB 150	1390
200	-	RB 200	3290
250	-	RB 250	6420

Cylindrical Rollers

Standards, Boundary dimensions

Cylindrical rollers of Through-hardening
Rolling bearings steel DIN 5402/part 1

Hardness

ART cylindrical rollers made from through - hardened rolling bearing steel according to DIN 17 230 have a surface hardness of **58** up to **65 HRC**.

Design features

ART cylindrical rollers are produced using the latest technology, with the modified surface profile (i.e. semi-crowned) as standard (see sketch below).

This modified profile features a cylindrical centre diameter (**A**) that blends into a slightly curved area (**B**) which blends into the roller radii (**r**) and end face.

This feature reduces considerably the negative effect of edge loading and, therefore, additional stresses.

For manufacturing reasons, small cylindrical rollers may have shallow dimples in their end faces.

Such dimples have a depth of approximately 0,5 mm, the diameter is approximately half the nominal roller diameter (D_w).

In cases where such dimpled cylindrical rollers are unsuitable for application reasons, it must be clearly stated on the order.

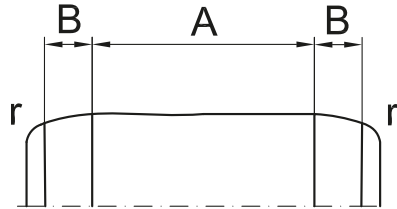

Tolerances for ART Cylindrical Rollers

Values of dimensional and geometrical accuracy of ART cylindrical rollers

Roller diameter Nominal ΦD_w	Tolerances		Gauge interval l	Gauge mean values (deviation range)	Roundness tolerance to DIN ISO 1101
	>	≤			
mm	μm		μm	μm	μm
- 26	-17	+11	2	-8 ... -1 0 +1 ... +6	1
26 40	-19,5	+10,5	3	-9 ... -1,5 0 +1,5 ... +6	1,2

Roller length Nominal L_w	Tolerances		Gauge interval l	Gauge mean values (deviation range)	Tolerance of end face runout to DIN ISO 1101
	>	≤			
mm	μm		μm	μm	μm
- 48	-20	+10	6	-18 / -12 / -6 / 0 / +6	6
48 -	-45	+15	10	-30 / -20 / -10 / 0 / +10	10

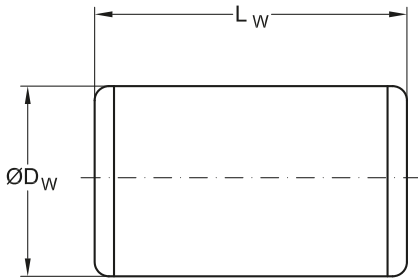

a

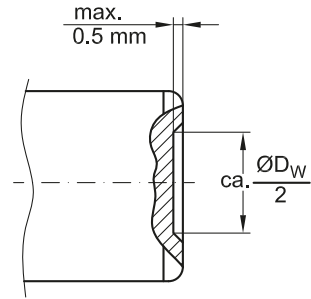

b

Grades, Tolerances

ART cylindrical rollers are classified grades according to their nominal diameters and lengths. Each grade is sorted into gauge ranges, each gauge is separately package.

Each package is clearly identified with the mean gauge interval of both, cylindrical roller diameter and roller length.

Where there are no specific Grade or gauge requirements specified the standard available cylindrical roller stock size will be despatched.

Designation

Cylindrical Rollers are classified according to their nominal diameters and lengths, each individual grade and gauge is separately packed and despatched.

ART Cylindrical Rollers made from chromium rolling bearing steel are designated following the system as shown below:

RC 6,5X9 P2/M6

where:

- RC** Symbol for cylindrical rollers from chromium rolling bearing steel
- 6,5** Nominal roller diameter, D_w [mm]
- 9** Nominal roller length, L_w [mm]
- P2** Diameter gauge **P2**
(the mean deviation of roller diameter of this specific lot equals + 2 μm)
- M6** Length gauge **M6**
(the mean deviation of roller length of

this specific lot is - 6 μm)

To avoid possible misinterpretations by poor visible printings etc., the **mean deviation** is stated according to the following system:

- P Plus**
e.g. **P2** = mean deviation + 2 μm
- N 0**
- M Minus**
e.g. **M6** = mean deviation - 6 μm

Therefore, the **mean diameter deviation** of a cylindrical roller from this specific lot is

6,502 mm \pm 1 μm .

The **mean roller length deviation** of a cylindrical roller from a specific lot is

8,994 mm \pm 3 μm .

Cylindrical Rollers to other Tolerances

ART also produces cylindrical rollers with reduced tolerances to customer order requirements.

ART will provide detailed information on request.

Cylindrical Rollers

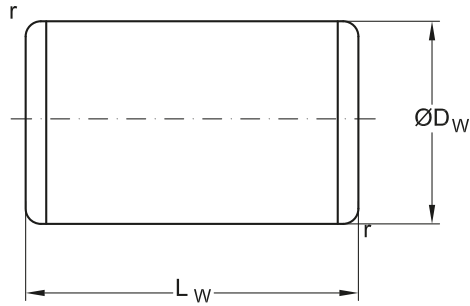

Dimensions				Designation	Mass per 100 rollers kg
D_W	L_W	r_{min} mm	r_{max}		
3	5	0,2	0,4	RC 3 X 5	0,027
3,5	5	0,2	0,4	RC 3,5 X 5	0,037
	8	0,2	0,4	RC 3,5 X 8	0,060
4	4	0,2	0,4	RC 4 X 4	0,038
	6	0,2	0,4	RC 4 X 6	0,058
	8	0,2	0,4	RC 4 X 8	0,078
4,5	6	0,2	0,6	RC 4,5 X 6	0,073
5	5	0,2	0,6	RC 5 X 5	0,075
	6	0,2	0,6	RC 5 X 6	0,091
	7	0,2	0,6	RC 5 X 7	0,106
	8	0,2	0,6	RC 5 X 8	0,121
	10	0,2	0,6	RC 5 X 10	0,152
5,5	5,5	0,2	0,6	RC 5,5 X 5,5	0,100
	8	0,2	0,6	RC 5,5 X 8	0,146
6	6	0,2	0,6	RC 6 X 6	0,130
	8	0,2	0,6	RC 6 X 8	0,178
	12	0,2	0,6	RC 6 X 12	0,261
6,5	6,5	0,2	0,6	RC 6,5 X 6,5	0,166
	9	0,2	0,6	RC 6,5 X 9	0,230

Cylindrical Rollers

Dimensions			Designation		Mass per 100 rollers
D_w	L_w	r_{min}	r_{max}		kg
		mm			
7	7	0,2	0,6	RC 7 X 7	0,206
	10	0,2	0,6	RC 7 X 10	0,30
	14	0,2	0,6	RC 7 X 14	0,42
7,5	7,5	0,2	0,6	RC 7,5 X 7,5	0,25
	11	0,2	0,6	RC 7,5 X 11	0,37
8	8	0,2	0,6	RC 8 X 8	0,31
	12	0,2	0,6	RC 8 X 12	0,47
9	9	0,3	0,7	RC 9 X 9	0,44
	14	0,3	0,7	RC 9 X 14	0,68
10	10	0,3	0,7	RC 10 X 10	0,60
	14	0,3	0,7	RC 10 X 14	0,85
11	11	0,3	0,7	RC 11 X 11	0,81
	15	0,3	0,7	RC 11 X 15	1,10
12	12	0,3	0,7	RC 12 X 12	1,04
	18	0,3	0,7	RC 12 X 18	1,57
13	13	0,4	0,8	RC 13 X 13	1,33
	20	0,4	0,8	RC 13 X 20	2,04
14	14	0,4	0,8	RC 14 X 14	1,66
	20	0,4	0,8	RC 14 X 20	2,38

Cylindrical Rollers

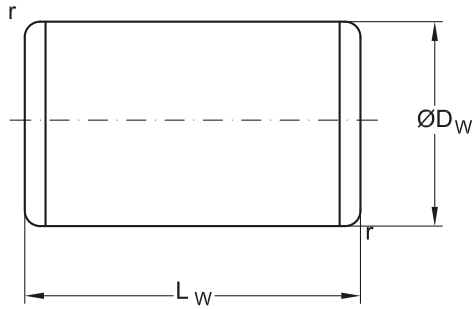

Dimensions				Designation	Mass per 100 rollers
D_W	L_W	r_{min}	r_{max}		kg
		mm			
15	15	0,4	0,8	RC 15 X 15	2,04
	22	0,4	0,8	RC 15 X 22	3,00
16	16	0,4	0,8	RC 16 X 16	2,48
	24	0,4	0,8	RC 16 X 24	3,73
17	17	0,4	1	RC 17 X 17	2,97
	24	0,4	1	RC 17 X 24	4,20
18	18	0,4	1	RC 18 X 18	3,57
	26	0,4	1	RC 18 X 26	5,10
19	19	0,4	1	RC 19 X 19	4,16
	28	0,4	1	RC 19 X 28	6,10
20	20	0,4	1	RC 20 X 20	4,85
	30	0,4	1	RC 20 X 30	7,30
21	21	0,5	1,1	RC 21 X 21	5,60
	30	0,5	1,1	RC 21 X 30	8,0
22	22	0,5	1,1	RC 22 X 22	6,4
	34	0,5	1,1	RC 22 X 34	10,0
23	23	0,5	1,1	RC 23 X 23	7,4
	34	0,5	1,1	RC 23 X 34	11,2
24	24	0,5	1,1	RC 24 X 24	8,4

Cylindrical Rollers

Dimensions				Designation	Mass per 100 rollers
D_W	L_W	r_{min}	r_{max}		
		mm			kg
24	36	0,5	1,1	RC 24 X 36	12,6
25	25	0,5	1,1	RC 25 X 25	9,5
	36	0,5	1,1	RC 25 X 36	13,7
26	26	0,5	1,1	RC 26 X 26	10,7
	40	0,5	1,1	RC 26 X 40	16,4
28	28	0,6	1,4	RC 28 X 28	13,3
	44	0,6	1,4	RC 28 X 44	21,0
30	30	0,6	1,4	RC 30 X 30	16,3
	48	0,6	1,4	RC 30 X 48	26,2
32	32	0,6	1,4	RC 32 X 32	19,9
	52	0,6	1,4	RC 32 X 52	32,4
34	34	0,6	1,4	RC 34 X 34	23,9
	55	0,6	1,4	RC 34 X 55	38,7
36	36	0,7	1,7	RC 36 X 36	28,3
	58	0,7	1,7	RC 36 X 58	45,7
38	38	0,7	1,7	RC 38 X 38	33,3
	62	0,7	1,7	RC 38 X 62	55,0
40	40	0,7	1,7	RC 40 X 40	38,9
	65	0,7	1,7	RC 40 X 65	63,0

Needle Rollers

Standards, Boundary dimensions

Needle rollers of through-hardened rolling bearing steel
DIN 5402 / part 3

Hardness

ART - needle rollers made from through - hardened rolling bearing steel according to DIN 17 230 generally, have a hardness value range of **58 to 65 HRC**.

Design features

ART Needle Rollers are produced using the latest technology.

One detail of outstanding importance to needle rollers is the modified profile that is established as a standard for all **ART needle rollers**, see sketch below.

The modified profile features a cylindrical section in the centre (**A**) that blends into a slightly curved area (**B**) which blends into the roller radii (**r**) and end face.

This feature reduces considerably the potentially negative effect of edge loading and, therefore, additional stresses.

Needle rollers are available in two different designs as standard (see sketch below).

Needle rollers of type "**B**" have spherical end faces, whilst needle rollers of the "**BF**" - design are produced with flat ends.

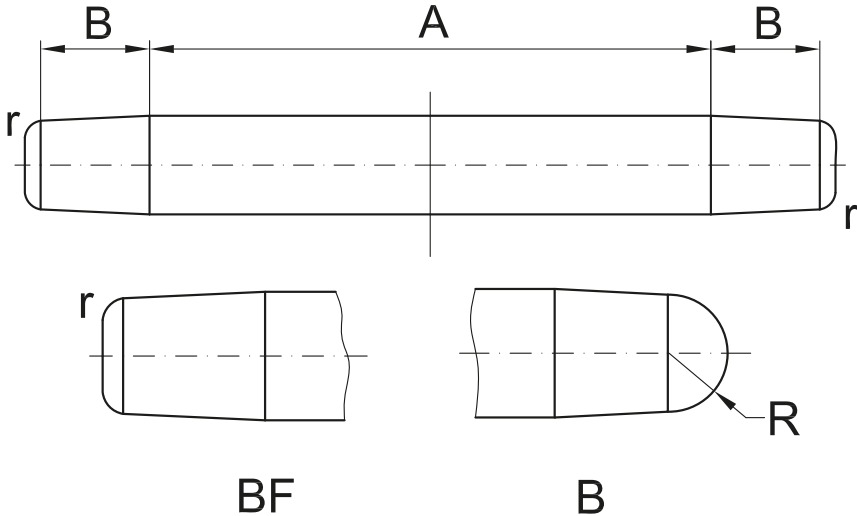

Grades, tolerances

ART Needle rollers are classified and graded according to their diameters into three **Grades (G2, G3 and G5)**.

Furthermore, the needle diameters of every grade are subdivided in **gauges**.

The tolerance ranges of each gauge are different depending on the grade.

Each package is clearly identified with the nominal needle roller diameter, grade, individual gauge range and length.

Each gauge is packed and despatched separately.

Where there is no specific grade and/or gauge requirements G2-Needle rollers from available stock sizes will be despatched.

The **length tolerances** of needle rollers correspond uniformly to ISO tolerance field **h13**.

Values of dimensional and geometrical accuracy of ART Needle Rollers

Grade	Tolerances		Gauge internal I	Gauges (limit values)	Roundness tolerance
	min.	max.			
mm	μm		μm	μm	μm
G2	-10	0	2	0 / -2, -1 / -3, -2 / -4, -3 / -5, -4 / -6 -5 / -7, -6 / -8, -7 / -9, -8 / -10	1
G3	-10	0	3	0 / -3, -1,5 / -4,5, -3 / -6, -4,5 / -7,5, -6 / -9, -7 / -10	1,2
G5	-10	0	5	0 / -5, -3 / -8, -5 / -10	2,5

The length tolerance of needle rollers correspond uniformly to ISO tolerance field h13.

Designation

The ART designation system for needle rollers made from chromium rolling bearing steel follows the system as shown below:

RN 2X13,8 BF M2/M4 G2

where:

- RN** Symbols for needle rollers from chromium rolling bearing steel
- 2** Nominal diameter of needle roller
D_w [mm]
- 13,8** Nominal length of needle roller,
L_w [mm]
- BF** Needle rollers with flat ends
- M2/M4** Diameter gauge **M2/M4**
(the physical roller diameter size of this specific lot lies between 1,998 to 1,996 mm)
- G2** Grade of needle rollers

To avoid possible misinterpretation by poor visible printings, etc., the **diameter** gauges are stated according the following system:

- N** **0**
- M** **Minus**
e.g. **M2/M4** = -2 / -4 μm

Needle Rollers

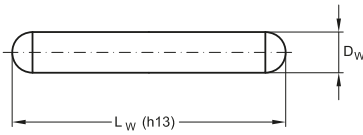

B

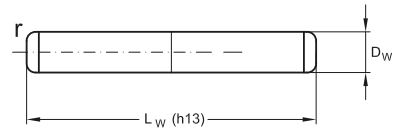

BF

Dimensions				Designation		Mass per 100 needles
D_w	L_w	r_{min}	r_{max}	"Sphered end" type	"Flat end" type	
						kg
mm						
1,5	5,8	0,1	0,4	RN 1,5 X 5,8 B	RN 1,5 X 5,8 BF	0,008
	7,8	0,1	0,4	RN 1,5 X 7,8 B	RN 1,5 X 7,8 BF	0,011
	9,8	0,1	0,4	RN 1,5 X 9,8 B	RN 1,5 X 9,8 BF	0,013
	11,8	0,1	0,4	RN 1,5 X 11,8 B	RN 1,5 X 11,8 BF	0,016
	13,8	0,1	0,4	RN 1,5 X 13,8 B	RN 1,5 X 13,8 BF	0,020
2	7,8	0,1	0,4	RN 2 X 7,8 B	RN 2 X 7,8 BF	0,02
	9,8	0,1	0,4	RN 2 X 9,8 B	RN 2 X 9,8 BF	0,02
	11,8	0,1	0,4	RN 2 X 11,8 B	RN 2 X 11,8 BF	0,03
	13,8	0,1	0,4	RN 2 X 13,8 B	RN 2 X 13,8 BF	0,03
	15,8	0,1	0,4	RN 2 X 15,8 B	RN 2 X 15,8 BF	0,04
	17,8	0,1	0,4	RN 2 X 17,8 B	RN 2 X 17,8 BF	0,04
	19,8	0,1	0,4	RN 2 X 19,8 B	RN 2 X 19,8 BF	0,05
	21,8	0,1	0,4	RN 2 X 21,8 B	RN 2 X 21,8 BF	0,05
2,5	7,8	0,1	0,4	RN 2,5 X 7,8 B	RN 2,5 X 7,8 BF	0,03
	9,8	0,1	0,4	RN 2,5 X 9,8 B	RN 2,5 X 9,8 BF	0,04
	11,8	0,1	0,4	RN 2,5 X 11,8 B	RN 2,5 X 11,8 BF	0,05
	13,8	0,1	0,4	RN 2,5 X 13,8 B	RN 2,5 X 13,8 BF	0,05

Needle Rollers

Dimensions				Designation		Mass per 100 needles
D_w	L_w	r_{min}	r_{max}	"Sphered end" type	"Flat end" type	
		mm				kg
2,5	15,8	0,1	0,4	RN 2,5 X 15,8 B	RN 2,5 X 15,8 BF	0,06
	17,8	0,1	0,4	RN 2,5 X 17,8 B	RN 2,5 X 17,8 BF	0,07
	19,8	0,1	0,4	RN 2,5 X 19,8 B	RN 2,5 X 19,8 BF	0,08
	21,8	0,1	0,4	RN 2,5 X 21,8 B	RN 2,5 X 21,8 BF	0,08
	23,8	0,1	0,4	RN 2,5 X 23,8 B	RN 2,5 X 23,8 BF	0,09
3	9,8	0,1	0,4	RN 3 X 9,8 B	RN 3 X 9,8 BF	0,05
	11,8	0,1	0,4	RN 3 X 11,8 B	RN 3 X 11,8 BF	0,07
	13,8	0,1	0,4	RN 3 X 13,8 B	RN 3 X 13,8 BF	0,08
	15,8	0,1	0,4	RN 3 X 15,8 B	RN 3 X 15,8 BF	0,09
	17,8	0,1	0,4	RN 3 X 17,8 B	RN 3 X 17,8 BF	0,10
	19,8	0,1	0,4	RN 3 X 19,8 B	RN 3 X 19,8 BF	0,11
	23,8	0,1	0,4	RN 3 X 23,8 B	RN 3 X 23,8 BF	0,13
	27,8	0,1	0,6	RN 3 X 27,8 B	RN 3 X 27,8 BF	0,15
3,5	29,8	0,1	0,6	RN 3,5 X 29,8 B	RN 3,5 X 29,8 BF	0,23
	34,8	0,1	0,6	RN 3,5 X 34,8 B	RN 3,5 X 34,8 BF	0,27
4	39,8	0,1	0,6	RN 4 X 39,8 B	RN 4 X 39,8 BF	0,40
5	49,8	0,1	0,6	RN 5 X 49,8 B	RN 5 X 49,8 BF	0,75



Adapter and Withdrawal Sleeves

General

Adapter and Withdrawal Sleeves are devices using to mount and secure rolling element bearings with tapered bores onto cylindrical shaft seats.

This enables the mounting or dismounting of rolling element bearings in a simple and effective way to for a variety of applications.

Since, adapter and withdrawal sleeves are able to adapt to shaft diameter variations within certain limits, larger than normal **shaft diameter tolerances** are accommodated.

The **geometrical accuracy**, however, must be more closely defined, as the forms errors of the shaft affect the running accuracy of the total bearing arrangement in a direct way.

Furthermore, using adapter or withdrawal sleeves allows bearing seats with lower surface qualities, (e.g. turned surfaces) to be acceptable. For applications where no accurate shaft guidance of bearings is required, bright drawn round bar stock may also be used.

Generally the following tolerances may be used for guidance:

Expected running accuracy	Diameter tolerance	Form accuracy
Normal	h7, h8, h9	$\frac{IT5}{2}$
Low	h10, h11	$\frac{IT7}{2}$

Adapter sleeves

Standards, boundary, dimensions

Adapter Sleeves

DIN 5415

General

Adapter sleeves (see sketch below) are slotted steel sleeves that have a tapered outer diameter, taper 1:12 on one side and a thread on the opposite side.

Small adapter sleeves may have phosphated surfaces, normally they are only oil preserved.

ART adapter sleeves are supplied complete with lock nut and locking washer as standard. Beside the standard design (see figure **a**), there are also larger adapter sleeves available with oil bores and oil distribution ducts, (prefix **OH**) as required for applying the oil injection method as shown in figure **b**.

On smooth straight shafts, (e.g. on a drawn round stock), adapter sleeves allow a simple positioning of bearings in any position, (see figure **c**).

In applications where bearings with adapter sleeves are mounted on straight shafts without axial support, (see figure **c**), their ability to accept axial forces is limited by the friction between the adapter sleeve and the shaft.

in the case of higher axial forces, the bearing needs to be secured additionally by **supporting rings** (see figure **d**).

When designing such supporting rings, however, the abutment dimensions recommended by the product tables must be considered.

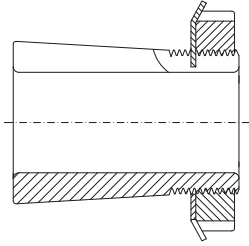

a

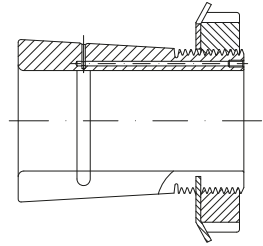

b

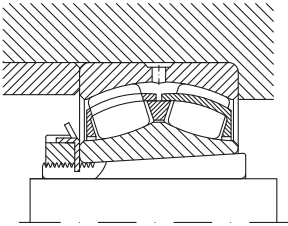

c

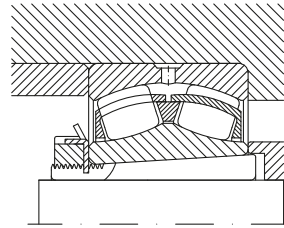

d

ART BEARINGS

Adapter Sleeves

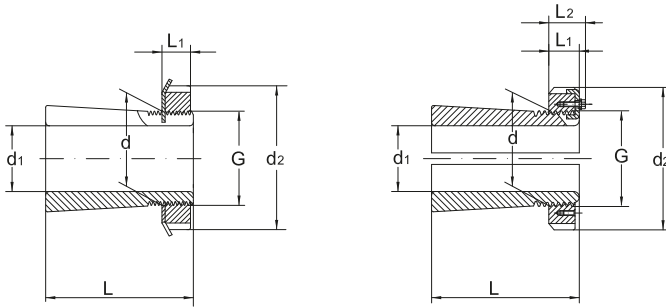

Shaft Φ		Dimension		Designation adapter sleeve, complete	Mass
d_1	d	d_2	L		
mm	mm				kg
17	20	32	24	H204	0,04
		32	28	H304	0,04
		32	31	H2304	0,05
20	25	38	26	H205	0,06
		38	29	H305	0,07
		38	35	H2305	0,09
25	30	45	27	H206	0,09
		45	31	H306	0,10
		45	38	H2306	0,11
30	35	52	29	H207	0,12
		52	35	H307	0,14
		52	43	H2307	0,15
35	40	58	31	H208	0,16
		58	36	H308	0,18
		58	46	H2308	0,22
40	45	65	33	H209	0,21
		65	39	H309	0,23
		65	50	H2309	0,27
45	50	70	35	H210	0,24
		70	42	H310	0,27
		70	55	H2310	0,34
50	55	75	37	H211	0,28
		75	45	H311	0,32
		75	59	H2311	0,39

Adapter Sleeves

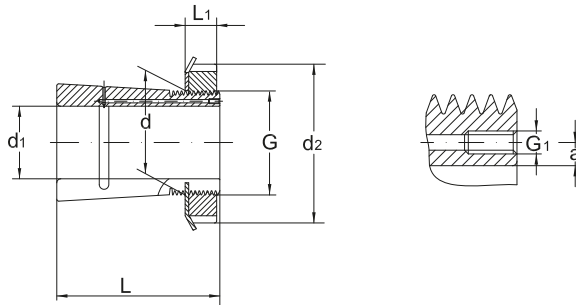

Shaft Φ	Thread	Dimensions				Lock nut	Locking Device
d_1	G	L_1	L_2	G_1	a		
mm							
17	M 20 X 1	7	-	-	-	MK4	MB4
	M 20 X 1	7	-	-	-	MK4	MB4
	M 20 X 1	7	-	-	-	MK4	MB4
20	M 25 X 1,5	8	-	-	-	MK5	MB5
	M 25 X 1,5	8	-	-	-	MK5	MB5
	M 25 X 1,5	8	-	-	-	MK5	MB5
25	M 30 X 1,5	8	-	-	-	MK6	MB6
	M 30 X 1,5	8	-	-	-	MK6	MB6
	M 30 X 1,5	8	-	-	-	MK6	MB6
30	M 35 X 1,5	9	-	-	-	MK7	MB7
	M 35 X 1,5	9	-	-	-	MK7	MB7
	M 35 X 1,5	9	-	-	-	MK7	MB7
35	M 40 X 1,5	10	-	-	-	MK8	MB8
	M 40 X 1,5	10	-	-	-	MK8	MB8
	M 40 X 1,5	10	-	-	-	MK8	MB8
40	M 45 X 1,5	11	-	-	-	MK9	MB9
	M 45 X 1,5	11	-	-	-	MK9	MB9
	M 45 X 1,5	11	-	-	-	MK9	MB9
45	M 50 X 1,5	12	-	-	-	MK10	MB10
	M 50 X 1,5	12	-	-	-	MK10	MB10
	M 50 X 1,5	12	-	-	-	MK10	MB10
50	M 55 X 2	12,5	-	-	-	MK11	MB11
	M 55 X 2	12,5	-	-	-	MK11	MB11
	M 55 X 2	12,5	-	-	-	MK11	MB11

Adapter Sleeves

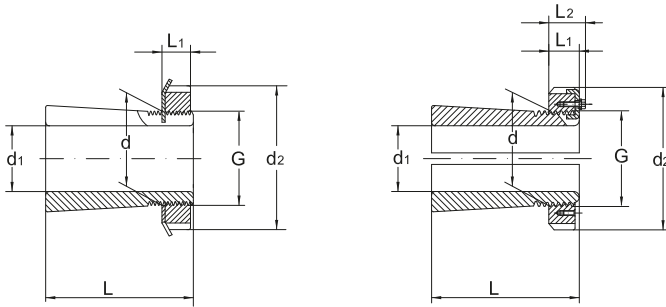

Shaft Φ	Dimension			Designation adapter sleeve, complete	Mass
	d_1	d	d_2		
mm	mm				kg
55	60	80	38	H212	0,31
			47	H312	0,35
			62	H2312	0,45
60	65	85	40	H213	0,36
			50	H313	0,42
			65	H2313	0,52
			52	H314	0,68
			68	H2314	0,88
65	75	98	43	H215	0,66
			55	H315	0,78
			73	H2315	1,1
70	80	105	46	H216	0,81
			59	H316	0,95
			78	H2316	1,2
75	85	110	50	H217	0,94
			63	H317	1,1
			82	H2317	1,35
80	90	120	52	H218	1,1
			65	H318	1,3
			86	H2318	1,6
85	95	125	55	H219	1,25
			68	H319	1,4
			90	H2319	1,8
90	100	130	58	H220	1,4

Adapter Sleeves

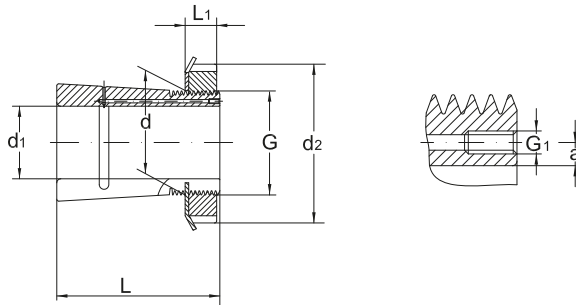

Shaft Φ	Thread	Dimensions				Lock nut	Locking Device
d_1	G	L_1	L_2	G_1	a		
mm							
55	M 60 X 2	13	-	-	-	KM12	MB 12
	M 60 X 2	13	-	-	-	KM12	MB12
	M 60 X 2	13	-	-	-	KM12	MB12
60	M 65 X 2	14	-	-	-	KM13	MB13
	M 65 X 2	14	-	-	-	KM13	MB13
	M 65 X 2	14	-	-	-	KM13	MB13
	M 70 X 2	14	-	-	-	KM14	MB14
	M 70 X 2	14	-	-	-	KM14	MB14
65	M 75 X 2	15	-	-	-	KM15	MB15
	M 75 X 2	15	-	-	-	KM15	MB15
	M 75 X 2	15	-	-	-	KM15	MB15
70	M 80 X 2	17	-	-	-	KM16	MB16
	M 80 X 2	17	-	-	-	KM16	MB16
	M 80 X 2	17	-	-	-	KM16	MB16
75	M 85 X 2	18	-	-	-	KM17	MB17
	M 85 X 2	18	-	-	-	KM17	MB17
	M 85 X 2	18	-	-	-	KM17	MB17
80	M 90 X 2	18	-	-	-	KM18	MB18
	M 90 X 2	18	-	-	-	KM18	MB18
	M 90 X 2	18	-	-	-	KM18	MB18
85	M 95 X 2	19	-	-	-	KM19	MB19
	M 95 X 2	19	-	-	-	KM19	MB19
	M 95 X 2	19	-	-	-	KM19	MB19
90	M 100 X 2	20	-	-	-	KM20	MB20

Adapter Sleeves

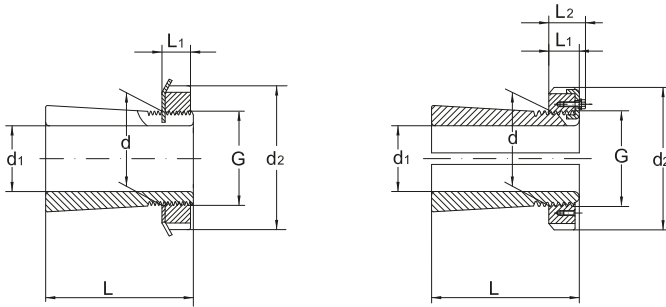

Shaft Φ	Dimension			Designation adapter sleeve, complete	Mass
	d_1	d	d_2		
mm	mm				kg
90	100	130	71	H320	1,6
		130	97	H2320	2
		130	76	H3120	1,8
95	105	140	60	H221	1,6
		140	74	H321	1,85
100	110	145	63	H222	1,8
		145	77	H322	2,05
		145	105	H2322	2,75
		145	81	H3122	2,1
110	120	155	112	H2324	3
		145	72	H3024	1,8
		155	88	H3124	2,5
115	130	165	121	H2326	4,45
		155	80	H3026	2,8
		165	92	H3126	3,45
125	140	180	131	H2328	5,4
		165	82	H3028	3,05
		180	97	H3128	4,1
135	150	195	139	H2330	6,4
		180	87	H3030	3,75
		195	111	H3130	5,25
140	160	210	147	H2332	8,8
		210	147	OH2332 H	8,8
		190	93	H3032	5,1

Adapter Sleeves

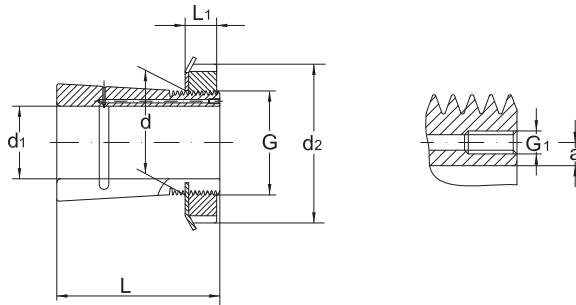

Shaft Φ	Thread	Dimensions				Lock nut	Locking Device
d_1	G	L_1	L_2	G_1	a		
mm							
90	M 100 X 2	20	-	-	-	KM20	MB20
	M 100 X 2	20	-	-	-	KM20	MB20
	M 100 X 2	20	-	-	-	KM20	MB20
95	M 105 X 2	20	-	-	-	KM21	MB21
	M 105 X 2	20	-	-	-	KM21	MB21
100	M 110 X 2	21	-	-	-	KM22	MB22
	M 110 X 2	21	-	-	-	KM22	MB22
	M 110 X 2	21	-	-	-	KM22	MB22
	M 110 X 2	31	-	-	-	KM22	MB22
110	M 120 X 2	22	-	-	-	KM24	MB24
	M 120 X 2	22	-	-	-	KML24	MBL24
	M 120 X 2	22	-	-	-	KM24	MB24
115	M 130 X 2	23	-	-	-	KM26	MB26
	M 130 X 2	23	-	-	-	KML26	MBL26
	M 130 X 2	23	-	-	-	KM26	MB26
125	M 140 X 2	24	-	-	-	KM28	MB28
	M 140 X 2	24	-	-	-	KML28	MBL28
	M 140 X 2	24	-	-	-	KM28	MB28
135	M 150 X 2	26	-	-	-	KM30	MB30
	M 150 X 2	26	-	-	-	KML30	MBL30
	M 150 X 2	26	-	-	-	KM30	MB30
140	M 160 X 3	28	-	-	-	KM32	MB32
	M 160 X 3	28	-	M 6	4,2	KM32	MB32
	M 160 X 3	27,5	-	-	-	KML32	MBL32

Adapter Sleeves

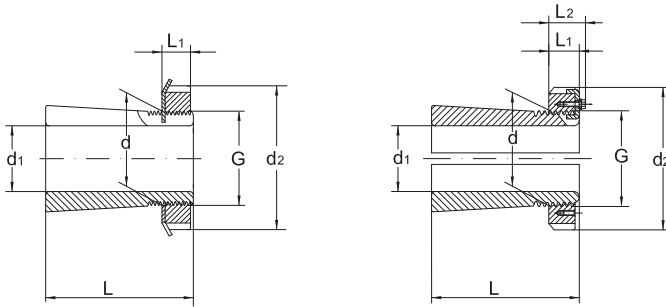

Shaft Φ		Dimension		Designation adapter sleeve, complete	Mass
d_1	d	d_2	L		
mm	mm				kg
140	160	190	93	OH3032 H	5,1
		210	119	H3132	7,25
		210	119	OH3132 H	7,25
150	170	220	154	H2334	9,9
		220	154	OH2334 H	9,9
		200	101	H3034	5,8
		200	101	OH3034 H	5,8
		220	101	H3134	8,1
		220	122	OH3134 H	8,1
160	180	230	161	H2336	11
		230	161	OH2336 H	11
		210	109	H3036	6,7
		210	109	OH3036 H	6,7
		230	131	H3136	9,15
		230	131	OH3136 H	9,15
170	190	240	169	H2338	12
		240	169	OH2338 H	12
		220	112	H3038	7,25
		220	112	OH3038 H	7,25
		240	141	H3138	10,5
		240	141	OH3138 H	10,5
180	200	250	176	H2340	13,5
		250	176	OH2340 H	13,5
		240	120	H3040	8,9

ART BEARINGS

ART BEARINGS



TÜRKİYE

Anadolu Rulman İmalat Sanayi ve Ticaret A.Ş.

Yaka Mahallesi 401. Sokak NO:17

PK:81700 Cumayeri/DÜZCE-TÜRKİYE

Phone: +90 380 735 51 54

Fax: +90 380 735 51 77

e-mail: info@anadolurulman.com.tr

web: www.anadolurulman.com.tr