

# PRODUCT BROCHURES

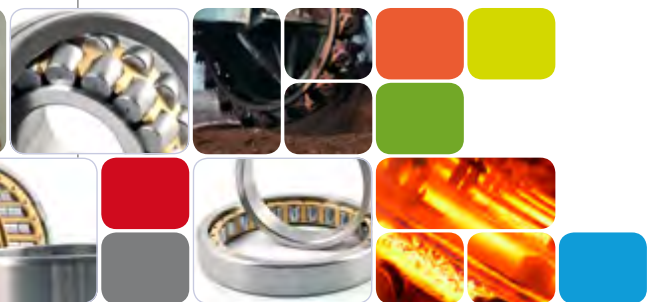

**RKB**  
BEARING INDUSTRIES

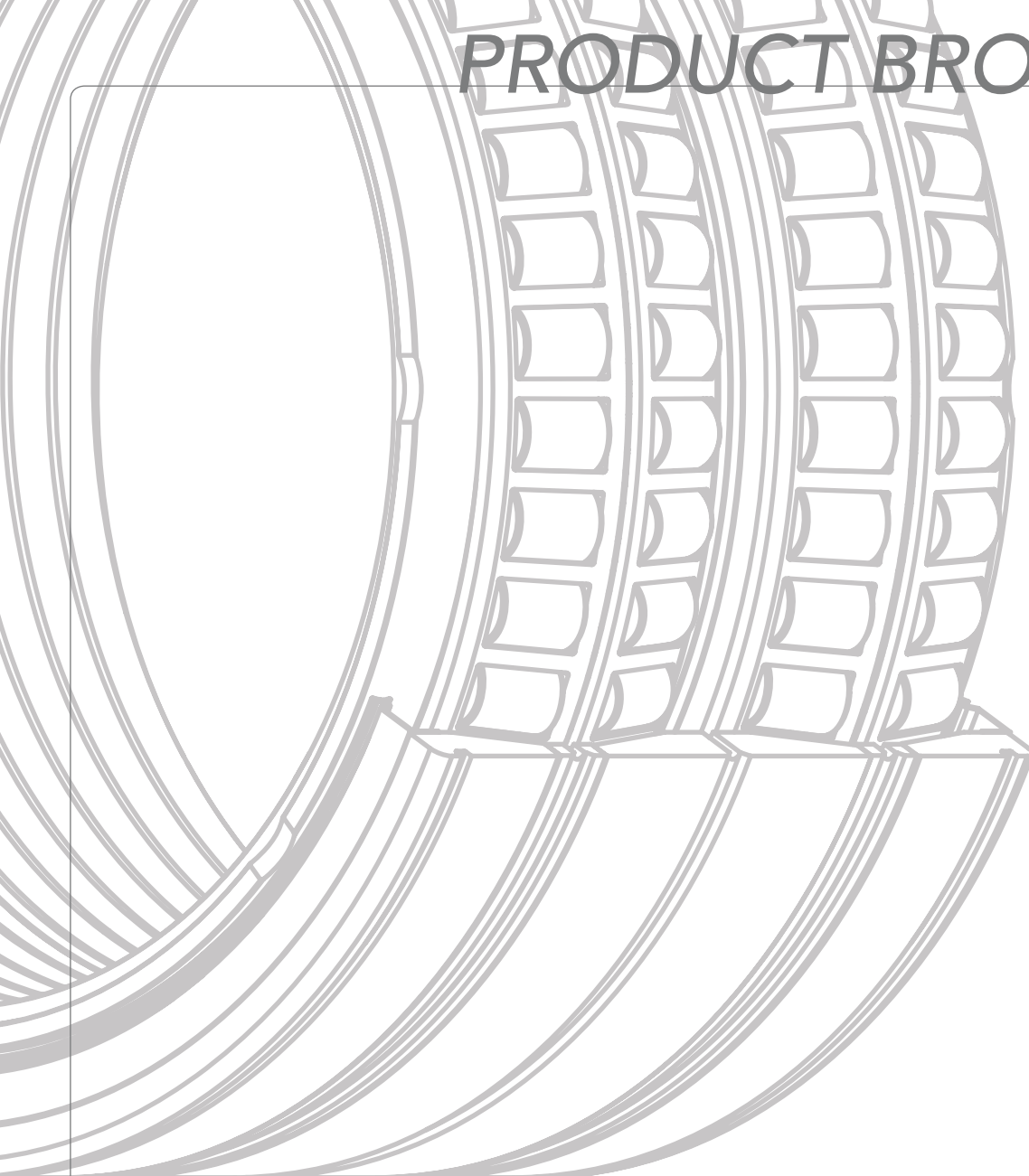

## *The Swiss premium class bearing manufacturer*

The RKB Bearing Industries Group is the Swiss manufacturing organization which has been operating in the bearing industry since 1936, with a monthly production capacity exceeding 350 tons of machined steel.

The experience gained over the years provides RKB with the know-how and expertise necessary for the development and manufacture of technological industrial bearings up to 1925 mm outer diameter.

RKB offers reliable cost-effective solutions, with extreme operational flexibility, leading-edge service, huge stock availability, short delivery time and the typical quality of a consistent premium-class bearing source. With a worldwide distribution network and exports to more than 50 countries, RKB is globally recognized as “*The AlternativePower*” in the bearing industry.

Publication **PBRKB.Rev03EN**

© RKB Europe SA

Every care has been taken to ensure the accuracy of the information in the present document but no liability can be accepted for any errors, omissions, losses and damages (direct, indirect, consequential).

Reproduction in whole or in part without our authorization is prohibited.

# Table of contents

## Deep groove ball bearings



## Angular contact ball bearings



## Spherical roller bearings

- MAIN DESIGNS
- SPECIAL DESIGNS



## Cylindrical roller bearings

- SINGLE ROW
- DOUBLE ROW
- MULTI ROW



## Tapered roller bearings

- SINGLE ROW
- DOUBLE ROW
- FOUR-ROW



## Thrust bearings

- SINGLE ROW
- DOUBLE ROW



## Product Table



## RKB ball bearings

The ball bearings (BBs) manufactured by RKB come in many designs, dimensions and series. They are conceived to withstand combined loads and high speeds, covering most requirements in a number of standard and special industrial applications. All RKB BBs are made from high quality materials and special heat treatments for superior performance.

Available in single and double row configuration, in open or sealed version, they are low-maintenance, which makes them an irreplaceable cost-effective solution in many cases. For large size BBs, RKB can also apply Bainite Hardening Treatment (HB) and High Temperature Dimensional Stabilization (S) on rings and balls. The bearing dimensional and running accuracy conforms to ISO/ABMA/GOST specifications.



## Deep groove ball bearings

RKB offers a wide range of deep groove ball bearings (DGBBs) in single row design (open, sealed or shielded), with proven performance in many industrial fields. Having optimized internal geometry, they can operate at high speeds, sustaining radial and axial loads in both directions and generating low friction.

RKB DGBBs are engineered to successfully respond to the most demanding application requirements, in terms of high speeds, heavy loads and low noise.

This is mainly due to the use of the best raw materials and manufacturing technology, that permit to deliver only premium deep groove ball bearings.



## Main designs

### M type

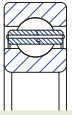

- One-piece inner and outer ring
- Two-piece machined brass cage guided on balls (M)
- Execution suitable for very high operating speeds
- Available with two-piece machined brass cage guided on inner ring (MB) or outer ring (MA)
- Available with axial lubrication grooves in the cage (S)
- Available with locating slot in outer ring for axial location (N1)

**HB**  
BAINITE HT

**S**  
STABILIZATION

**O+**  
OPTIMIZED

### J type

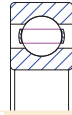

- One-piece inner and outer ring
- High strength two-piece pressed steel cage guided on balls (J)
- Execution suitable for high operating speeds
- Available with snap ring groove in outer ring for axial location (N)

**HB**  
BAINITE HT

**S**  
STABILIZATION

### TN type

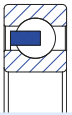

- One-piece inner and outer ring
- Moulded glass fiber reinforced polyamide snap-in cage guided on balls (TN)
- Execution suitable for very high accelerations and operating speeds

**HB**  
BAINITE HT

**S**  
STABILIZATION

**R+**  
REINFORCED

### ZZ type

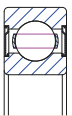

- One-piece inner and outer ring
- High strength two-piece pressed steel cage guided on balls (J)
- Two non-contacting steel shields at both sides (ZZ)
- Supplied already filled with grease for maintenance free operations
- Shielded type to keep the grease inside the bearing without compromising the limiting speed

**HB**  
BAINITE HT

**S**  
STABILIZATION

**O+**  
OPTIMIZED

### 2RS type

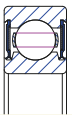

- One-piece inner and outer ring
- High strength two-piece pressed steel cage guided on balls (J)
- Two contacting rubber seals at both sides (2RS)
- Supplied already filled with grease for maintenance free operations
- Sealed type to keep the grease inside the bearing and enhance contaminant exclusion

**HB**  
BAINITE HT

**S**  
STABILIZATION

**O+**  
OPTIMIZED





## *RKB ball bearings*

The ball bearings (BBs) manufactured by RKB come in many designs, dimensions and series. They are conceived to withstand combined loads and high speeds, covering most requirements in a number of standard and special industrial applications. All RKB BBs are made from high quality materials and special heat treatments for superior performance.

Available in single and double row configuration, in open or sealed version, they are low-maintenance, which makes them an irreplaceable cost-effective solution in many cases. For large size BBs, RKB can also apply Bainite Hardening Treatment (HB) and High Temperature Dimensional Stabilization (S) on rings and balls. The bearing dimensional and running accuracy conforms to ISO/ABMA/GOST specifications.



## *Angular contact ball bearings*

The angular contact ball bearings (ACBBs) produced by RKB are used in a wide array of machines where combined loads, high speeds and runout accuracy are required. Available in single or double row configuration, they can be manufactured with different types of cage (machined brass, pressed steel or polyamide) and dimensional precisions.

Single row ACBBs can be directly paired by RKB in face-to-face (DF) or back-to-back (DB) configuration, depending on load conditions, presence of tilting moments and misalignment magnitude in the application.



## Main designs

### M type

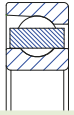

- One-piece inner and outer ring
- One-piece machined brass cage guided on balls (M)
- Available with machined brass cage guided on inner ring (MB)
- Single non-universal bearing execution
- Suitable for very high operating speeds
- Available with 25°, 30° or 40° contact angle

**HB** **S**  
BAINITE HT STABILIZATION

### QJ type

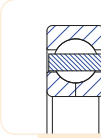

- One-piece outer ring
- Two-piece inner ring circumferentially split
- One-piece machined brass cage guided on outer ring (MA)
- Supports only axial loads
- Two locating slots (N2)
- Available also with one-piece inner ring and two-piece outer ring (Q)

**HB** **S**  
BAINITE HT STABILIZATION

### DB type

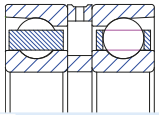

- Back-to-back arrangement (DB) of two ACBBs
- One-piece machined brass cage guided on balls (M)
- Preset or adjusted BEP on customer's request
- Available with machined brass cage guided on inner ring (MB)
- Available with inner and/or outer spacers featuring lubrication grooves and/or lubrication holes
- Stiffer arrangement to withstand tilting moments

**HB** **S** **O+**  
BAINITE HT STABILIZATION OPTIMIZED

### DF type

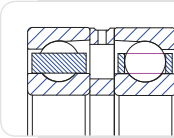

- Face-to-face arrangement (DF) of two ACBBs
- One-piece machined brass cage guided on balls (M)
- Preset or adjusted BEP on customer's request
- Available with machined brass cage guided on inner ring (MB)
- Available with inner and/or outer spacers featuring lubrication grooves and/or lubrication holes

**HB** **S** **O+**  
BAINITE HT STABILIZATION OPTIMIZED

### DFm type

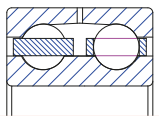

- Double row ACBB face-to-face arrangement (DF)
- Non-separable open design
- One-piece machined brass cage guided on inner ring (MB)
- Lubrication grooves and holes in outer rings
- Supports high combined loads

**HB** **S**  
BAINITE HT STABILIZATION

### DB+ZZ type

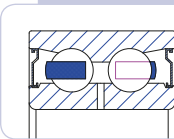

- Double row ACBB back-to-back arrangement (DB)
- Non-separable shielded design (ZZ)
- Moulded glass fiber reinforced polyamide snap-in cage guided on balls (TN)
- Available with lubrication holes in the inner ring
- Shielded type to keep the grease inside the bearing without compromising the limiting speed
- Supports high combined loads

**HB** **S** **O+** **R+**  
BAINITE HT STABILIZATION OPTIMIZED REINFORCED



## RKB spherical roller bearings

The spherical roller bearings (SRBs) manufactured by RKB are engineered to withstand high radial forces and moderate axial forces acting in both directions. RKB SRBs can dynamically accommodate misalignments due to shaft bending. They are produced with cylindrical or tapered bore, in open or sealed execution. Depending on application requirements, RKB Bainite Hardening Treatment (HB) and High Temperature Dimensional Stabilization (S) can be applied on bearing rings and rollers. Moreover, as for dimensions, RKB spherical roller bearings are manufactured according to ISO/ABMA/GOST specifications. As a consequence, they are fully interchangeable with all the bearings that meet the relevant international standards.



### A complete range

The range of RKB spherical roller bearings covers most requirements of standard and special industrial applications, in severe and critical working conditions.

RKB offers a wide portfolio of open and sealed SRBs in all diameter and width series. While the narrow low-section bearings (e.g. 238 series) feature high speed capabilities as well as low weight and minimum space dimensions, the wide high-section bearings (e.g. 233 series) have higher load carrying capacities.

All RKB SRBs put together experience in design with proven performance in all major industries.

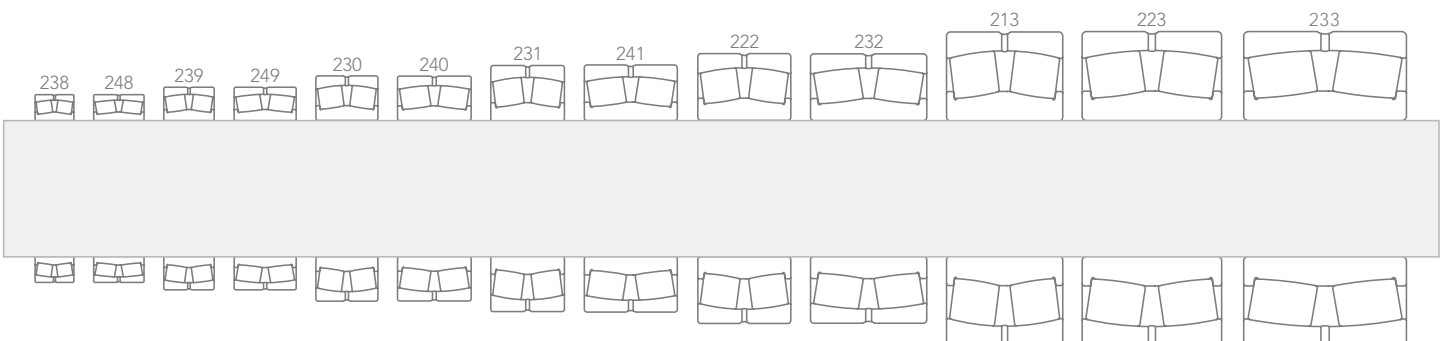



### Main designs

#### MA type



- Design used for medium and large size bearings
- Inner ring with integral side ribs
- Symmetrical roller profile
- Two-piece machined brass cage guided on the outer ring
- Lubrication groove and holes in the outer ring
- Optimized separable cage for better performance in case of different rolling element speed
- Available with lubrication groove and three lubrication holes in the outer ring and six lubrication holes in the inner ring (W513)



#### MB type

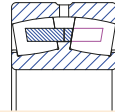

- Design used for medium size bearings operating at medium to high speeds, featuring high load carrying capacities
- Inner ring with integral side and central ribs
- Symmetrical or asymmetrical roller profile
- Two-piece machined brass cage guided on the inner ring
- Lubrication groove and holes in the outer ring
- Available with lubrication groove and three lubrication holes in the outer ring and six lubrication holes in the inner ring (W513)



#### CA type

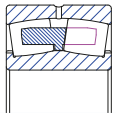

- Design used for large size bearings, withstanding high radial loads and moderate axial loads in both directions
- Inner ring with integral side ribs
- Symmetrical roller profile
- One-piece double pronged machined brass or steel (CAF) cage with integral slinger guided on the inner ring
- Lubrication groove and holes in the outer ring
- Available with lubrication groove and three lubrication holes in the outer ring and six lubrication holes in the inner ring (W513)



#### CC type

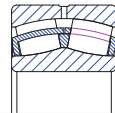

- Design used for medium size bearings operating at medium to high speeds and featuring high load carrying capacities
- Ribless inner ring
- Symmetrical or asymmetrical roller profile
- Two-piece window type pressed steel cage guided on the inner ring
- Lubrication groove and holes in the outer ring
- Available with lubrication groove and three lubrication holes in the outer ring and six lubrication holes in the inner ring (W513)



#### ECA type

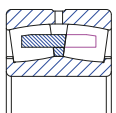

- Design used for large size bearings, based on CA design, with optimized roller set
- Inner ring with integral side ribs
- Symmetrical roller profile
- One-piece double pronged machined brass cage with separated slinger guided on the inner ring
- Lubrication groove and holes in the outer ring
- Available with lubrication groove and three lubrication holes in the outer ring and six lubrication holes in the inner ring (W513)



## RKB spherical roller bearings

The spherical roller bearings (SRBs) manufactured by RKB are engineered to withstand high radial forces and moderate axial forces acting in both directions. RKB SRBs can dynamically accommodate misalignments due to shaft bending. They are produced with cylindrical or tapered bore, in open or sealed execution. Depending on application requirements, RKB Bainite Hardening Treatment (HB) and High Temperature Dimensional Stabilization (S) can be applied on bearing rings and rollers. Moreover, as for dimensions, RKB spherical roller bearings are manufactured according to ISO/ABMA/GOST specifications. As a consequence, they are fully interchangeable with all the bearings that meet the relevant international standards.

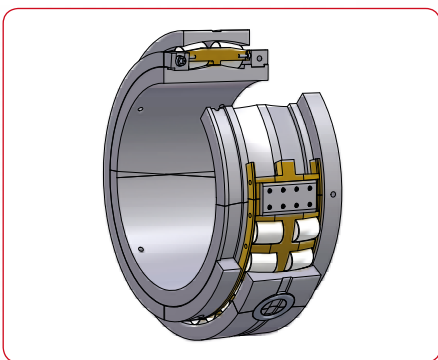

## Tailor made solutions

Besides the main spherical roller bearing designs, RKB has developed new solutions according to specific application requirements.

The special designs include SEALED SRBs, for smooth operation in contaminated environments, ROVSX type, expressly designed for vibratory equipment, WOR execution, suitable for gear output shaft of truck concrete mixers, and SPLIT bearings to make maintenance operations easier at hard-to-reach positions.

If duly applied, these special designs are cost effective for the customer, since they allow increased bearing life expectancy and reduced machine downtime.

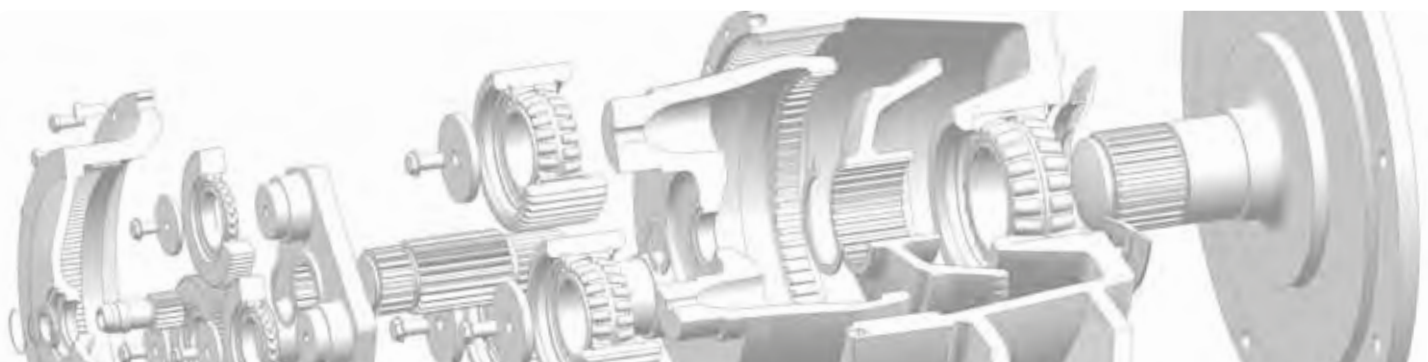

### Special designs

#### SEALED type



- Design used for medium and large size bearings operating at medium speeds
- Inner ring with integral side ribs
- Symmetrical roller profile
- One-piece double pronged machined brass cage with integral slinger guided on the inner ring
- Integral rubber seals on both bearing sides for harsh working conditions (2CZ)
- Lubrication groove and holes in the outer ring
- Available with plugged lubrication holes in the outer ring (W77)
- Available with two-piece window type pressed steel cage guided on the inner ring



#### ROVSX type

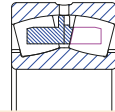

- Design used for vibratory equipment
- Inner ring with integral side ribs
- Symmetrical roller profile
- Two-piece machined brass cage guided on the outer ring
- Radial internal clearance higher than normal CN
- Running accuracy higher than standard execution
- Available with lubrication groove, three lubrication holes in the outer ring and six lubrication holes in the inner ring (W513)



#### WOR type

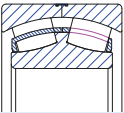

- Design used for gear output shaft of truck concrete mixers
- Inner ring with integral central rib
- Symmetrical or asymmetrical roller profile
- Two-piece pressed steel window type cage guided on the inner ring
- Wider outer ring (WOR) in one piece or split into two halves
- Permissible misalignment greater than standard execution
- Available with two-piece machined brass cage guided on the inner ring



#### SPLIT type

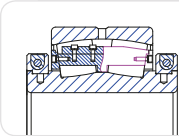

- Design used for medium and large size bearings
- Wider inner ring with integral side ribs
- Symmetrical roller profile
- Two-piece bolted double pronged machined brass cage guided on the inner ring
- Engineered for hard-to-reach positions (e.g. bucket wheel excavators)
- Design for facilitated mounting, dismounting and maintenance, and reduced machine downtime



#### ECCS type

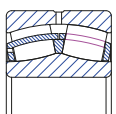

- Design used for small to medium size bearings
- Ribless inner ring
- Symmetrical roller profile
- Two-piece pressed steel window type cage with slotted open face to improve lubricant flow and separated slinger guided on the inner ring
- Lubrication groove and six holes in the outer ring (W33X)
- Suitable for harsh environments
- Available with lubrication groove, three lubrication holes in the outer ring and six lubrication holes in the inner ring (W513)



## RKB cylindrical roller bearings

The cylindrical roller bearings (CRBs) manufactured by RKB are produced in many designs, dimensions and series, to withstand heavy radial loads and medium speeds, covering most of the requirements in a variety of standard and special industrial applications. All CRBs manufactured by RKB offers the highest load rating capacities, improved internal geometry, high quality materials and special heat treatments for superior performance. RKB CRBs are available with cylindrical or tapered bore in single, double or multi row configuration. Depending on application requirements, RKB Bainite Hardening Treatment (HB) and High Temperature Dimensional Stabilization (S) can be applied on bearing rings and rollers. The bearing dimensional and running accuracy conforms to ISO/ABMA/GOST specifications.

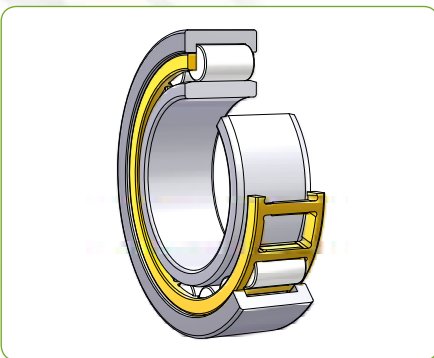

## Single row cylindrical roller bearings

RKB offers a wide range of single row cylindrical roller bearing designs in normal or reinforced execution with increased performance in critical applications.

Roller and raceway profiles are designed to attain optimized stress distribution while minimizing the edge effect, especially under critical conditions.

The portfolio of RKB single row CRBs is finally enhanced by the high-capacity full complement bearings (cageless), which reach higher load carrying capacities within the same boundary dimensions.



### Main designs

#### NU type

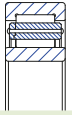

- Outer ring with two integral side ribs
- Ribless inner ring
- Two-piece machined brass cage guided on rollers (M) or outer ring (MA)
- Available with riveted or AVH cage also with lubrication grooves
- Optimized raceway geometry and roller profile
- To be used in non-locating position



#### N type

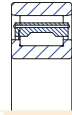

- Ribless outer ring
- Inner ring with two integral side ribs
- Two-piece machined brass cage guided on rollers (M) or inner ring (MB)
- Lubrication grooves in side faces of inner ring
- Available with riveted or AVH cage also with lubrication grooves
- Optimized raceway geometry and roller profile
- To be used in non-locating position



#### NUP type

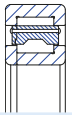

- Outer ring with two integral side ribs
- Inner ring with one integral side rib and one loose rib
- Two-piece machined brass cage guided on rollers (M) or outer ring (MA)
- Available with riveted or AVH cage also with lubrication grooves
- Optimized raceway geometry and roller profile
- Can be used in locating position



#### NJ type

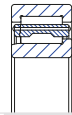

- Outer ring with two integral side ribs
- Inner ring with one integral side rib
- Two-piece machined brass cage guided on rollers (M) or outer ring (MA)
- Available with riveted or AVH cage also with lubrication grooves
- Optimized raceway geometry and roller profile
- Can be used in one direction locating position



#### NJG type

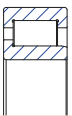

- Outer ring with two integral side ribs
- Inner ring with one integral side rib
- Full complement (cageless) separable design for increased carrying capacities
- Reduced maximum rotational speed compared to caged design
- Optimized raceway geometry and roller profile
- Can be used in one direction locating position



#### NJGL type

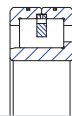

- Outer ring circumferentially split
- Inner ring with one integral side rib
- Lamellar brass cage design
- Designed to maintain high carrying capacities without compromising the rotational speed capability
- Optimized raceway geometry and roller profile



#### NCF type

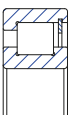

- Outer ring with one integral side rib and retaining ring
- Inner ring with two integral side ribs
- Full complement (cageless) design for increased load carrying capacities
- Reduced maximum rotational speed compared to caged design
- Optimized raceway geometry and roller profile
- Can be used in one direction locating position



## *RKB cylindrical roller bearings*

The cylindrical roller bearings (CRBs) manufactured by RKB are produced in many designs, dimensions and series, to withstand heavy radial loads and medium speeds, covering most of the requirements in a variety of standard and special industrial applications. All CRBs manufactured by RKB offers the highest load rating capacities, improved internal geometry, high quality materials and special heat treatments for superior performance. RKB CRBs are available with cylindrical or tapered bore in single, double or multi row configuration. Depending on application requirements, RKB Bainite Hardening Treatment (HB) and High Temperature Dimensional Stabilization (S) can be applied on bearing rings and rollers. The bearing dimensional and running accuracy conforms to ISO/ABMA/GOST specifications.



## *Double row cylindrical roller bearings*

With a wide range of executions of double row cylindrical roller bearings (DRCRBs), RKB is able to fulfill any requirement in demanding applications such as large size gearboxes, machine tools, grinding mills and crushers.

To ensure superior performance, RKB double row cylindrical roller bearings are manufactured from high quality special steels, heat treated in optimized automatic lines.

With improved internal geometry and profile, DRCRBs can withstand high radial loads within a narrow cross section.



### Main designs

#### NNU type

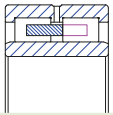

- Outer ring with three integral ribs
- Ribless inner ring
- One-piece double pronged machined brass or steel cage
- Annular groove and lubrication holes in outer ring
- Optimized raceway geometry and roller profile
- Available with cylindrical and tapered bore
- Available with locating slots in outer ring, lubrication holes in inner ring, lubrication grooves in side faces of inner and outer rings
- Available with steel pin type cage and pierced roller design



#### NN type

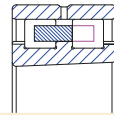

- Ribless outer ring
- Inner ring with three integral ribs
- One-piece double pronged machined brass cage
- Annular groove and lubrication holes in outer ring
- Optimized raceway geometry and roller profile
- Available with tapered and cylindrical bore
- Available with steel pin type cage and pierced roller design



#### SL01 (NNC-C) type

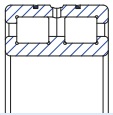

- Split outer ring with two integral ribs, clamped with a retaining ring
- Inner ring with three integral ribs
- Full complement (cageless) design for increased load carrying capacities
- Reduced maximum rotational speed compared to caged design
- Annular groove and lubrication holes in outer ring
- Optimized raceway geometry and roller profile
- Can be used in locating position



#### SL02 (NNCL-C) type

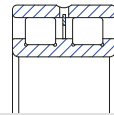

- Ribless outer ring
- Inner ring with three integral ribs
- Full complement (cageless) design for increased load carrying capacities
- Reduced maximum rotational speed compared to caged design
- Annular groove and lubrication holes in outer ring
- Separating ring between the two rows of rollers
- Optimized raceway geometry and roller profile
- Can be used in locating position



#### SL04 (NNF) type

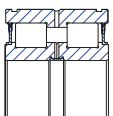

- Outer ring with one central integral rib
- Split inner ring with three integral ribs, clamped with a retaining ring
- Full complement (cageless) design for increased load carrying capacities
- Reduced maximum rotational speed
- Annular groove and lubrication holes in outer and inner ring
- Optimized raceway geometry and roller profile
- Integrated rubber seals on both bearing sides to avoid contamination
- Available filled with grease
- Can be used in locating position



#### SL18 (NNCF) type

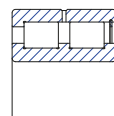

- Outer ring with one integral side rib and retaining ring
- Inner ring with three integral ribs
- Full complement (cageless) design for increased load carrying capacities
- Reduced maximum rotational speed compared to caged design
- Optimized raceway geometry and roller profile
- Can be used in one direction locating position
- Available with annular groove and lubrication holes in outer or inner ring



## RKB cylindrical roller bearings

The cylindrical roller bearings (CRBs) manufactured by RKB are produced in many designs, dimensions and series, to withstand heavy radial loads and medium speeds, covering most of the requirements in a variety of standard and special industrial applications. All CRBs manufactured by RKB offers the highest load rating capacities, improved internal geometry, high quality materials and special heat treatments for superior performance. RKB CRBs are available with cylindrical or tapered bore in single, double or multi row configuration. Depending on application requirements, RKB Bainite Hardening Treatment (HB) and High Temperature Dimensional Stabilization (S) can be applied on bearing rings and rollers. The bearing dimensional and running accuracy conforms to ISO/ABMA/GOST specifications.

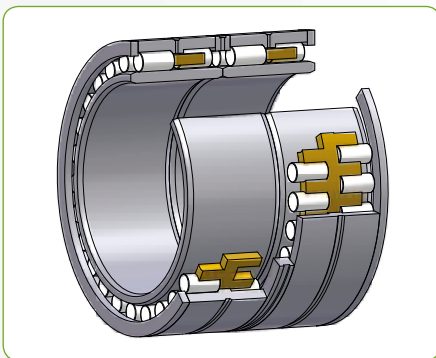
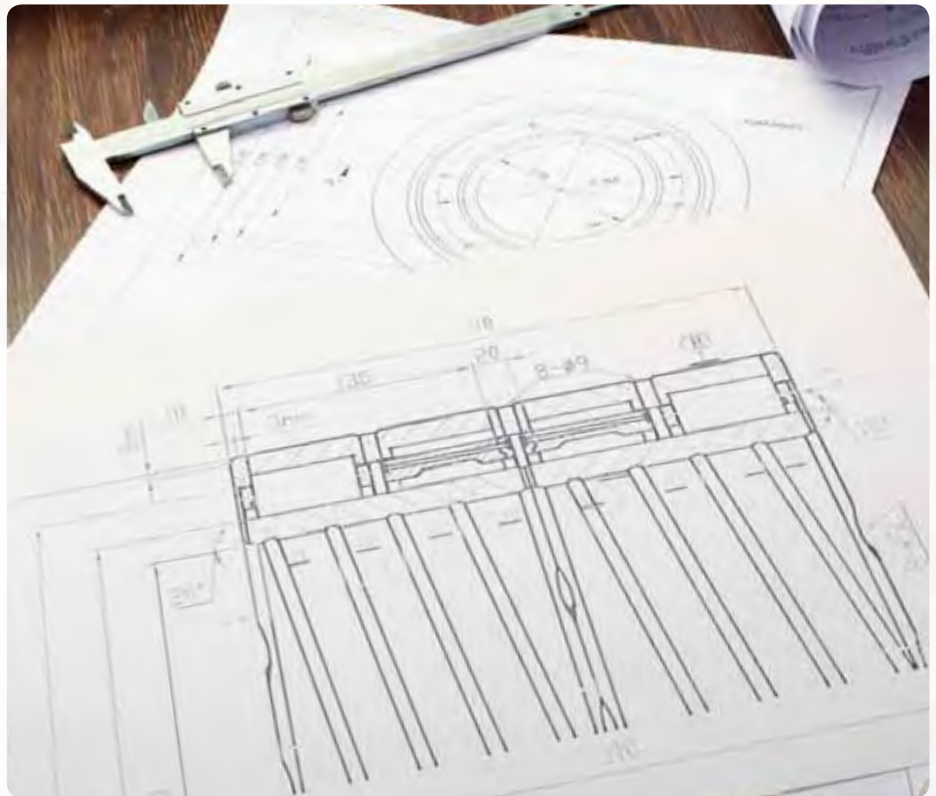

## Multi row cylindrical roller bearings

Multi row cylindrical roller bearings, also known as MULTIROLL, are made up of two parts: inner ring (L) and outer assembly (R), which includes outer rings, cage and four rows of rollers.

They are mainly used in rolling mill stands, where they are subjected to very high radial loads and impacts combined with medium-low speeds.

RKB MULTIROLL bearings are manufactured in different executions, to suit a wide range of applications and environments, above all in the harsh conditions of the steel and aluminum industry.





### Main designs

#### AF2D type

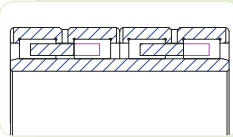

- Design used for small and medium size bearings
- One-piece ribless inner ring
- Two-piece outer ring with three integral ribs
- Double pronged high strength machined steel cage for increased stiffness and resistance to corrosive environments
- Annular groove and lubrication holes in outer ring
- Available with lubrication grooves in rings side faces
- Available with double pronged machined brass cage (A2D)



#### GB2DX type

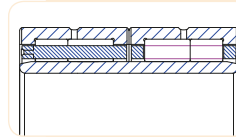

- Designed for rolling mill stands with automatic roll changing device
- One-piece ribless inner ring with increased length of chamfers to facilitate mounting
- Two-piece outer ring with integral ribs
- Two-piece reinforced window type machined brass cage with integral rivets (AVH) for optimized roller drop
- Long-short roller arrangement for better load distribution and reduced edge stress
- Optimized for oil lubrication and automatic grease lubrication systems



#### F2CII/EVO type

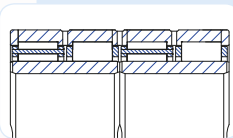

- Design used for large size bearings
- Two-piece ribless inner ring with lubrication grooves in side faces
- Two-piece outer ring with separated side flanges and one central spacer
- Two-piece pin type steel cage with lightened design for optimized lubrication
- Pierced rollers design for increased carrying capacities
- Available with two-piece window type riveted machined brass cage (EVO)



#### D2CII type

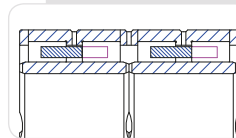

- Design used for medium and large size bearings
- Two-piece ribless inner ring with lubrication grooves in side faces
- Two-piece outer ring with separated side flanges and one central spacer
- Double pronged machined brass cage
- Annular groove and lubrication holes in outer ring
- Design for facilitated mounting and dismounting



#### Q2ACEVO type

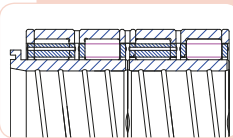

- Design used for large size bearings with increased shoulder on inner ring for seal seating
- Two-piece inner ring with lubrication grooves in side faces
- Two-piece outer ring with separated side flanges and one central spacer
- Two-piece window type riveted machined brass cage
- Annular groove and lubrication holes in outer ring



## *RKB tapered roller bearings*

The tapered roller bearings (TRBs) manufactured by RKB are engineered to withstand combined radial and thrust loads. Available in a rich portfolio of designs and sizes, in standardized and non-standardized dimensional series, RKB tapered roller bearings can be in metric or inch measurements and represent the state of the art. Manufactured from high hardness materials, featuring unparalleled fatigue strength and resistance to wear, RKB TRBs provide excellent performance even under severe operating conditions. RKB's single row, matched pair, double and four-row tapered roller bearings are optimized to ensure increased load carrying capacities and high stiffness in special applications. RKB Bainite Hardening Treatment (HB) and High Temperature Dimensional Stabilization (S) can be applied on bearing rings and rollers.



## *Single row tapered roller bearings*

RKB single row and matched pair tapered roller bearings (SRTRBs) are widely used in all industrial segments, in standard and critical applications.

The tighter dimensional tolerances, obtained through an extremely high precision manufacturing technology, and the optimized inner geometry (E-Type class) make of such bearings a reliable solution to improve the performance of any machine.

Naturally, the matched pairs can be assembled according to the customer's special needs (e.g. a given axial internal clearance). The bearing dimensional and running accuracy conforms to ISO/ABMA/GOST specifications.



### Main designs

#### TS type

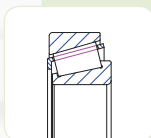

- Ribless outer ring (cup)
- Inner ring with two integral ribs (cone)
- One-piece window type pressed steel cage
- Supports radial and axial loads in one direction
- Suitable for medium to high operating speeds
- Separable design
- Optimized geometry (E-Type)
- Optimized roller profile (ZB)
- Available in metric and inch sizes



#### DB type

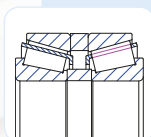

- Matched set of single row TRBs (back-to-back arrangement)
- Available with cup and cone spacers (plain or with lubrication holes)
- Supports radial and axial loads in both directions
- High arrangement stiffness
- Reduced angular misalignment
- Optimized geometry (E-Type)
- Optimized roller profile (ZB)
- Preset or adjusted BEP on customer's request
- Available in metric and inch sizes



#### DF type

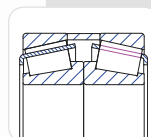

- Matched set of single row TRBs (face-to-face arrangement)
- Available with cup and cone spacers (plain or with lubrication holes)
- Supports radial and axial loads in both directions
- Low arrangement stiffness
- Increased angular misalignment
- Optimized geometry (E-Type)
- Optimized roller profile (ZB)
- Preset or adjusted BEP on customer's request
- Available in metric and inch sizes

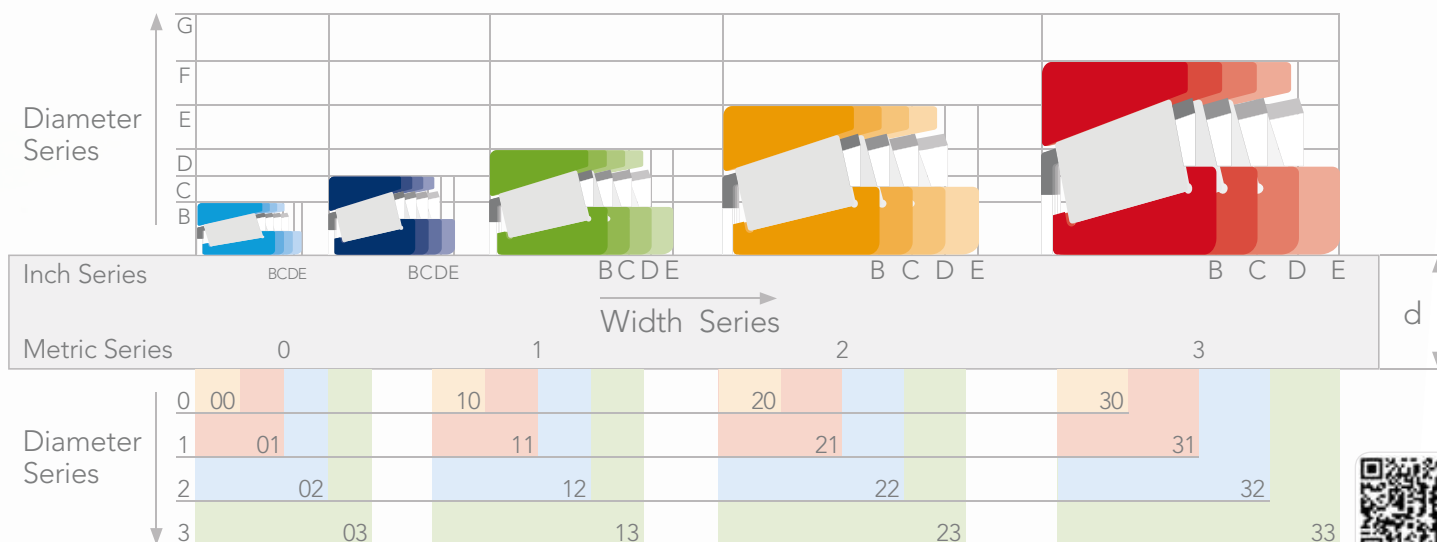



## RKB tapered roller bearings

The tapered roller bearings (TRBs) manufactured by RKB are engineered to withstand combined radial and thrust loads. Available in a rich portfolio of designs and sizes, in standardized and non-standardized dimensional series, RKB tapered roller bearings can be in metric or inch measurements and represent the state of the art. Manufactured from high hardness materials, featuring unparalleled fatigue strength and resistance to wear, RKB TRBs provide excellent performance even under severe operating conditions. RKB's single row, matched pair, double and four-row tapered roller bearings are optimized to ensure increased load carrying capacities and high stiffness in special applications. RKB Bainite Hardening Treatment (HB) and High Temperature Dimensional Stabilization (S) can be applied on bearing rings and rollers.



## Double row tapered roller bearings

RKB double row tapered roller bearings (DRTRBs) are produced in several configurations (TDO, TDOS, TDI, TDIS) to support combined forces and locate the shaft in both directions.

Manufactured with a given axial clearance (BEP), DRTRBs can fully exploit their potential in a variety of industries and applications. In order to manufacture products with the highest possible resistance to fatigue and wear, RKB makes use of different bearing steel grades and special heat treatments. The bearing dimensional and running accuracy conforms to ISO/ABMA/GOST specifications.



### Main designs

#### TDO type

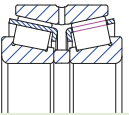

- One ribless outer ring (one double cup)
- Two inner rings with two ribs each (two single cones)
- Two one-piece window type pressed steel cages
- One single spacer between inner rings (plain or with lubrication grooves and holes)
- Supports radial and axial loads in both directions
- High arrangement stiffness
- Reduced angular misalignment
- Optimized roller profile (ZB)
- Preset or adjusted BEP on customer's request
- Available in metric and inch sizes



#### TDONASW type

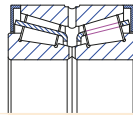

- One ribless outer ring (one double cup)
- Two inner rings with two ribs each (two single cones)
- Two one-piece window type pressed steel cages
- Lubrication grooves in cones internal side face
- Lateral shields or seals for contaminant exclusion
- Execution without spacer
- Supports radial and axial loads in both directions
- High arrangement stiffness
- Optimized roller profile (ZB)
- Preset or adjusted BEP on customer's request
- Available in metric and inch sizes



#### TDI type

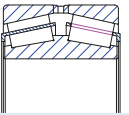

- Two ribless outer rings (two single cups)
- One inner ring with three ribs (one double cone)
- Two one-piece window type pressed steel cages
- One single spacer between outer rings (plain or with lubrication grooves and holes)
- Supports radial and axial loads in both directions
- Optimized roller profile (ZB)
- Preset or adjusted BEP on customer's request
- Available in metric and inch sizes



#### TDIS type

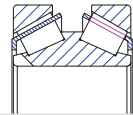

- Two ribless outer rings (two single cups)
- One inner ring with three ribs (one double cone)
- Two one-piece window type pressed steel cages
- Supports axial loads in both directions
- Designed with increased contact angle
- Suitable for high axial load carrying capacity
- Available with steel pin type cage and pierced roller design
- Available with one or more antirotation keyway slots on each side of double cone
- Available in metric and inch sizes



#### TDISS type

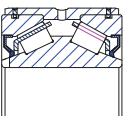

- Two ribless outer rings (two single cups)
- One inner ring with three ribs (one double cone)
- Two one-piece window type pressed steel cages
- Lateral seals for contaminant exclusion
- Preset or adjusted BEP on customer's request
- Designed with increased contact angle
- Suitable for high axial load carrying capacity
- Available with one or more antirotation keyway slots on each side of double cone
- Outer bush with annular groove and lubrication holes
- Available in metric and inch sizes





## *RKB tapered roller bearings*

The tapered roller bearings (TRBs) manufactured by RKB are engineered to withstand combined radial and thrust loads. Available in a rich portfolio of designs and sizes, in standardized and non-standardized dimensional series, RKB tapered roller bearings can be in metric or inch measurements and represent the state of the art. Manufactured from high hardness materials, featuring unparalleled fatigue strength and resistance to wear, RKB TRBs provide excellent performance even under severe operating conditions. RKB's single row, matched pair, double and four-row tapered roller bearings are optimized to ensure increased load carrying capacities and high stiffness in special applications. RKB Bainite Hardening Treatment (HB) and High Temperature Dimensional Stabilization (S) can be applied on bearing rings and rollers.

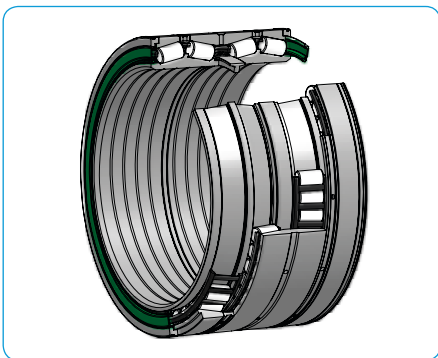

## *Four-row tapered roller bearings*

RKB four-row tapered roller bearings (FRTRB) are produced mainly in TQO and TQI configuration, in open and sealed version.

Supplied with the required axial internal clearance (BEP), they are mainly employed on work rolls of rolling mill applications.

The use of high quality raw materials, special heat treatments, and innovative sealing solutions are at the base of their higher operating reliability and longer service life expectancy. The bearing dimensional and running accuracy conforms to ISO/ABMA/GOST specifications.



### Main designs

#### TQO type

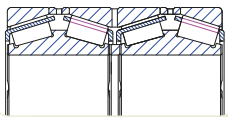

- Three ribless outer rings (one double cup, two single cups) plus two cup spacers (plain or with lubrication grooves and holes)
- Two inner rings with three ribs (two double cones) plus one cone spacer (plain or with lubrication holes)
- Four one-piece window type steel cages
- Supports radial and axial loads in both directions
- Preset or adjusted BEP on customer's request
- Available with helical groove in the bore (G)
- Marked zones on cups side face to facilitate mounting and maintenance operations
- Available in metric and inch sizes



#### TQO NO SPACER/G type

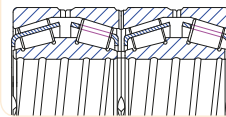

- Three ribless outer rings (one double cup, two single cups)
- Two inner rings with three ribs (two double cones)
- Four one-piece window type pressed steel cages
- Supports radial and axial loads in both directions
- Preset or adjusted BEP on customer's request
- Available with helical groove in the bore (G)
- Lubrication grooves in double cone side faces
- Marked zones on cups sides face to facilitate mounting and maintenance operations
- Available in metric and inch sizes



#### TQO PIERCED/G type

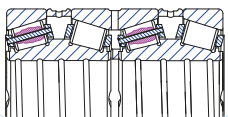

- Three ribless outer rings (one double cup, two single cups) plus two cup spacers (plain or with lubrication grooves and holes)
- Two inner rings with three ribs (two double cones) plus one cone spacer (plain or with lubrication holes)
- Four two-piece steel pin type cages
- Pierced roller execution to increase load capacity
- Preset or adjusted BEP on customer's request
- Available with helical groove in the bore (G)
- Marked zones on cups side face to facilitate mounting and maintenance operations
- Available in metric and inch sizes



#### TQOS/AVS2/G type

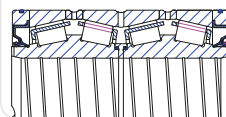

- Three ribless outer rings (one double cup, two single cups) plus two cup spacers (plain or with lubrication grooves and holes)
- Two inner rings with three ribs (two double cones)
- Four one-piece window type steel cages
- Preset or adjusted BEP on customer's request
- Marked zones on cups side face to facilitate mounting and maintenance operations
- Lateral flanges with lip seals and o-rings on bearing both sides
- Designed with Anti-Vortex System cone spacer seal set
- Available in metric and inch sizes



#### TQIT type

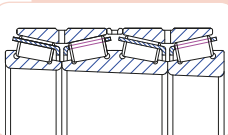

- Two ribless outer rings (two double cup) plus one cup spacer (plain or with lubrication grooves and holes)
- Three inner rings with side ribs (one double cone, two single cones)
- Four one-piece window type steel cages
- Preset or adjusted BEP on customer's request
- Available with helical groove in the bore (G)
- Available with cylindrical (TQI) or tapered bore (TQIT)
- Marked zones on cups side face to facilitate mounting and maintenance operations
- Available in metric and inch sizes



## RKB thrust bearings

The thrust bearings (TBs) manufactured by RKB are designed to support high axial loads and, in some cases, even moderate radial loads. The manufacturing program includes single and double direction TBs with flat or spherical housing locating washers to meet any requirements in various industrial applications. Thanks to the improved internal geometry and the use of the most suitable raw materials, all RKB TBs attain the highest axial load ratings and the best reliability. Depending on application requirements, RKB Bainite Hardening Treatment (HB) and High Temperature Dimensional Stabilization (S) can be applied on bearing rings and rolling elements. The bearing dimensional and running accuracy conforms to ISO/ABMA/GOST specifications.

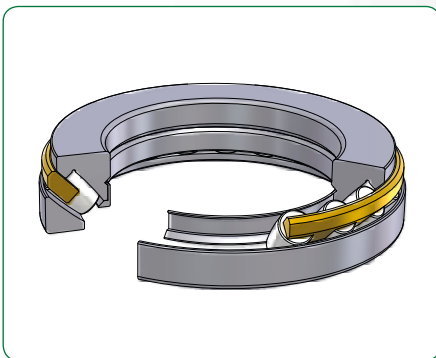

## Single direction thrust bearings

The broad portfolio of single direction thrust bearings (SDTBs) engineered and produced by RKB offers cost-effective solutions for the most demanding industries.

SDTBs can withstand only unidirectional axial loads, axially locating the shaft. Roller and raceway profiles are designed and manufactured to reduce stresses and minimize roller-edge effect.

Depending on machine requirements and operating conditions, they can be customized to enhance application performance in a reliable and efficient way.





### Main designs

#### 51M type

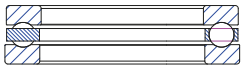

- Flat housing locating washer
- Separable design
- One-piece machined brass cage (M) guided on balls
- Supports unidirectional axial loads
- Available with sphered housing washer



#### EM type



- Asymmetrical roller profile
- One-piece machined brass cage (M) guided on shaft washer (M)
- Reinforced and optimized execution (E)
- Supports unidirectional axial loads and angular misalignment



#### EMevo type

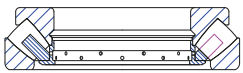

- Asymmetrical roller profile
- One-piece EVO type machined brass cage guided on shaft (M)
- Reinforced and optimized execution (E)
- Supports unidirectional axial loads and angular misalignment



#### EJ type

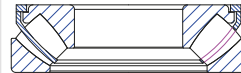

- Asymmetrical roller profile
- High strength pressed steel cage (J) guided on shaft washer
- Reinforced and optimized execution (E)
- Supports unidirectional axial loads and angular misalignment



#### 81M type

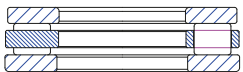

- Flat housing locating washer
- Low cross section separable design
- Two-piece machined brass cage (M) guided on rollers
- Supports unidirectional axial loads
- Available with sphered housing washer



#### 89M type

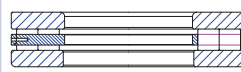

- Flat housing locating washer
- Two rows of rollers
- Two-piece machined brass cage (M) guided on rollers
- Low cross section separable design
- Supports unidirectional axial loads



#### TKCR type

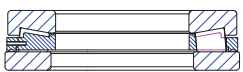

- Two-piece machined brass cage (M)
- Supports unidirectional axial loads
- Stiff arrangement



#### TKv type

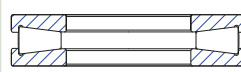

- Full complement (cageless) design for increased carrying capacities
- Supports unidirectional axial loads
- Stiff arrangement
- Reduced limiting speed compared to caged design



#### TKSD type

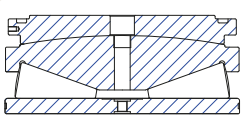

- Full complement cageless design conceived for extremely high axial loads
- Special execution for screw-down mechanism
- Available with sphered shaft washer and pressure plate
- Reduced limiting speed





## RKB thrust bearings

The thrust bearings (TBs) manufactured by RKB are designed to support high axial loads and, in some cases, even moderate radial loads. The manufacturing program includes single and double direction TBs with flat or spherical housing locating washers to meet any requirements in various industrial applications. Thanks to the improved internal geometry and the use of the most suitable raw materials, all RKB TBs attain the highest axial load ratings and the best reliability. Depending on application requirements, RKB Bainite Hardening Treatment (HB) and High Temperature Dimensional Stabilization (S) can be applied on bearing rings and rolling elements. The bearing dimensional and running accuracy conforms to ISO/ABMA/GOST specifications.

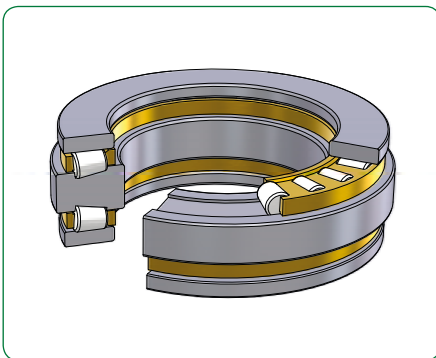
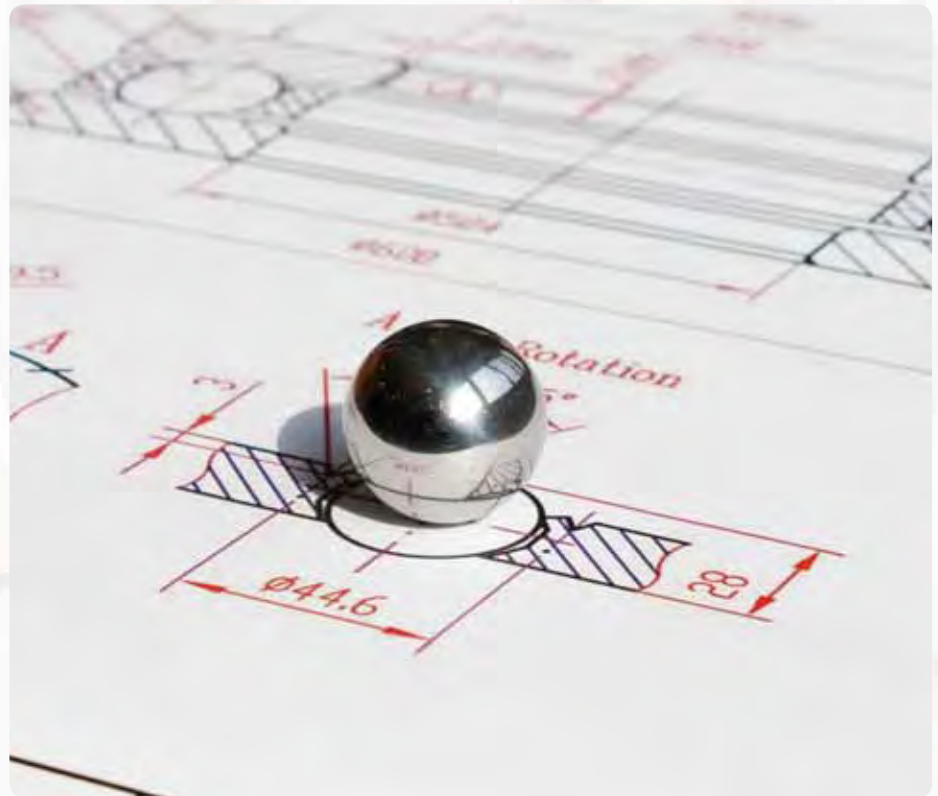

## Double direction thrust bearings

Double direction thrust bearings (DDTBs) are generally composed of two rolling element-cage assemblies, one shaft washer and two housing washers. Being supported by the housing washers, they are able to accommodate very high axial loads acting in both directions, fully axially locating the shaft.

The DDTBs designed by RKB come in a variety of configurations, in standard or enhanced execution. Their extremely high load carrying capacities, obtained through the improved internal geometry and the application of special heat treatments, make them an irreplaceable and efficient solution in many critical applications.



### Main designs

#### 52M type



- Flat housing washers
- One-piece machined brass cage (M) guided on balls
- Separable design
- Supports medium to high bidirectional axial loads
- Suitable for applications requiring both medium to high carrying capacities and good limiting speeds



#### WS+GS type

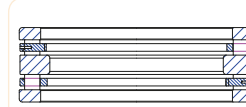

- Flat housing washers
- Separable components unit: shaft washers (WS) plus housing washers (GS)
- Two-piece machined brass cage (M) guided on rollers
- Stiff arrangement sensitive to misalignments
- Supports very high bidirectional axial loads



#### TTK1 type

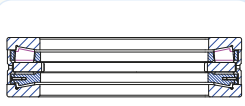

- Separable compact units
- Two-piece machined brass cage (M) guided on shaft washer
- Intermediate washer with internal centering on shaft
- Preset or adjusted BEP on customer's request
- Stiff arrangement very sensitive to misalignments
- Supports very high bidirectional axial loads
- Available with lubrication grooves and holes in outer spacer



#### TTK2 type

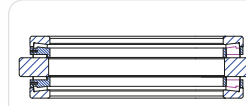

- Low cross section separable compact units
- Two-piece machined brass cage (M) guided on shaft washer
- Intermediate washer with external centering on the housing
- Preset or adjusted BEP on customer's request
- Stiff arrangement very sensitive to misalignments
- Supports very high bidirectional axial loads



# PRODUCT TABLE

## Cylindrical Roller Bearings

O.D. up to 1800 mm

Single Row Cylindrical Roller Bearings

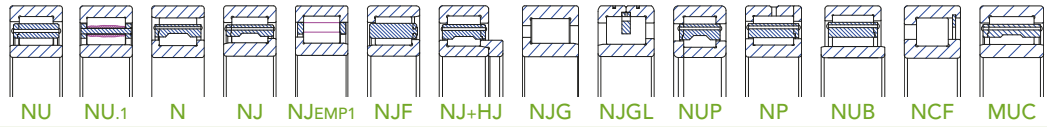

O.D. up to 1800 mm

Double Row Cylindrical Roller Bearings

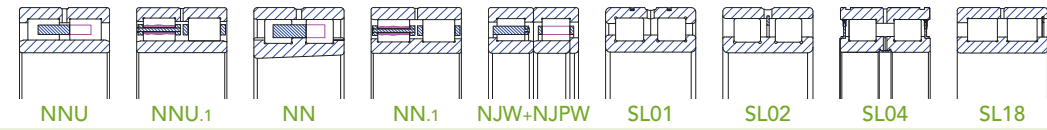

O.D. up to 1400 mm

Multi Row Cylindrical Roller Bearings

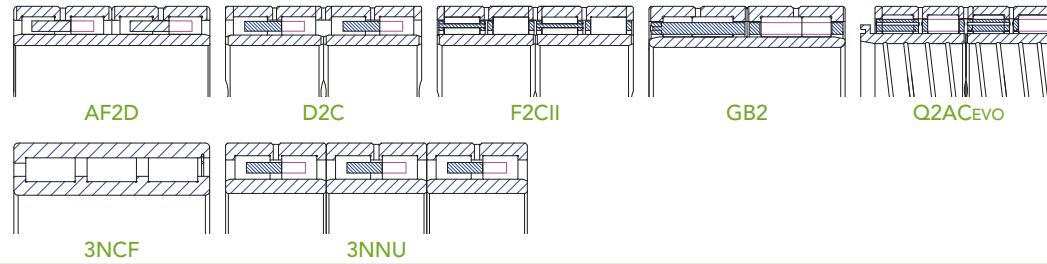

RADIAL

AXIAL

CYLINDRICAL ROLLERS

O.D. up to 1600 mm

Single Direction Cylindrical Roller Thrust Bearings

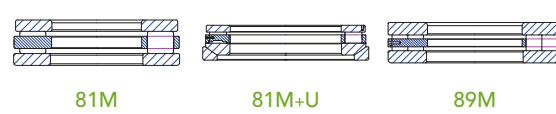

Double Direction Cylindrical Roller Thrust Bearings

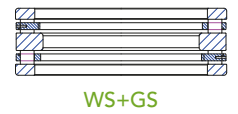

## Tapered Roller Bearings

O.D. up to 1800 mm

Single Row Tapered Roller Bearings

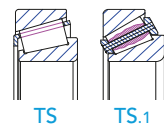

Single Row Paired Tapered Roller Bearings

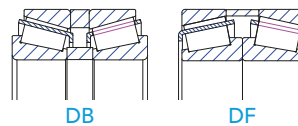

O.D. up to 1925 mm

Double Row Tapered Roller Bearings

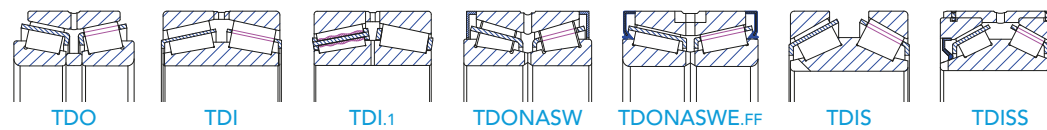

O.D. up to 1925 mm

Multi Row Tapered Roller Bearings

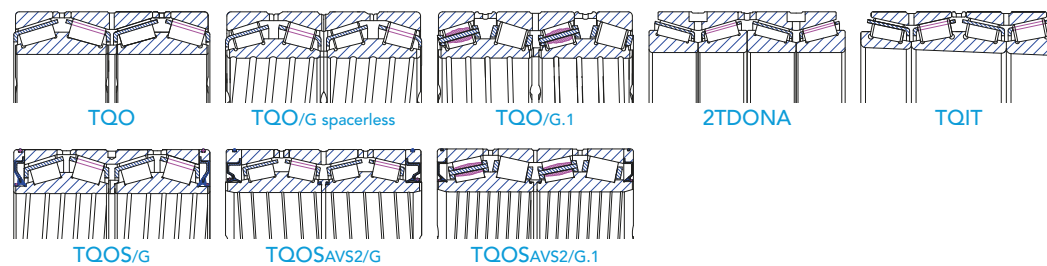

RADIAL

AXIAL

TAPERED ROLLERS

O.D. up to 1600 mm

Single Direction Tapered Roller Thrust Bearings

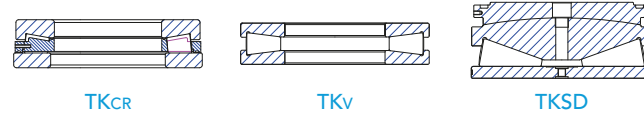

O.D. up to 1600 mm

Double Direction Tapered Roller Thrust Bearings

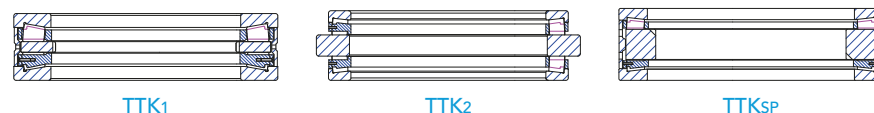

## Ball Bearings

O.D. up to 1900 mm

Single Row  
Deep Groove  
Ball Bearings

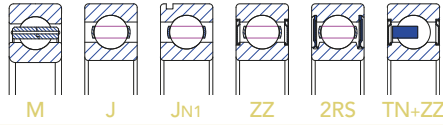

Single Row  
Angular Contact  
Ball Bearings

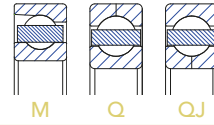

O.D. up to 1925 mm

Single Row Paired  
Angular Contact  
Ball Bearings

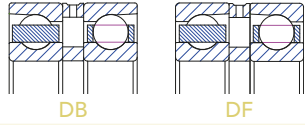

Double Row  
Angular Contact  
Ball Bearings

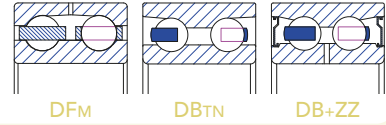

O.D. up to 1600 mm

Single Direction  
Thrust  
Ball Bearings

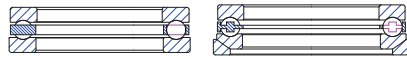

Double Direction  
Thrust  
Ball Bearings

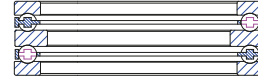

## Spherical Roller Bearings

O.D. up to 1580 mm

Spherical  
Roller Bearings

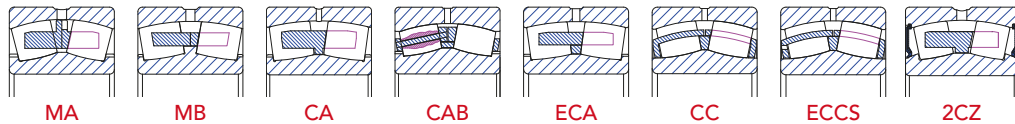

O.D. up to 1400 mm

Toroidal  
Roller Bearings

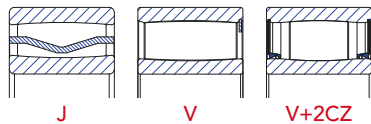

O.D. up to 1400 mm

Spherical Roller  
Thrust Bearings

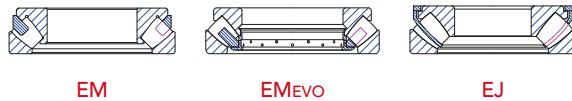

## Other Products

O.D. up to 400 mm

Track and Needle  
Roller Bearings

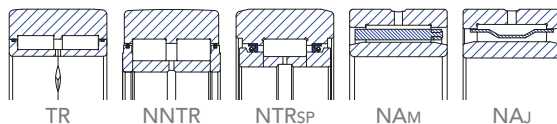

O.D. up to 1800 mm

Special and Split  
Roller Bearings

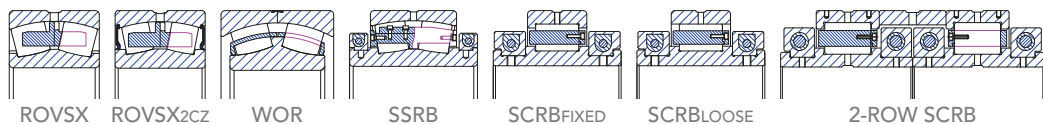

Slewing  
Bearings

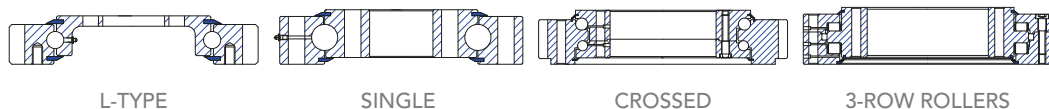

### Notes

1. Bearing dimensional and running accuracy according to ISO/AFBMA/GOST standards
2. All bearings available in metric and inch sizes, with cylindrical or tapered bore
3. Special features available on request





# RKB

BEARING INDUSTRIES

Via Primo Agosto · 6828 Balerna · Switzerland  
P.O. Box 16 · 6830 Chiasso 3 · Switzerland  
Phone +41 91 260 09 30 · Fax +41 91 260 09 50  
info@rkbeurope.com · www.rkbbearings.com

*The Alternative Power*

